



ERST-HOLZ[®]

WWW.ERST-HOLZ.DE

Artikel-Nr.: 90.82-40-12

Datum: 29.05.2019

Seite 01 von 04

Montageanleitung

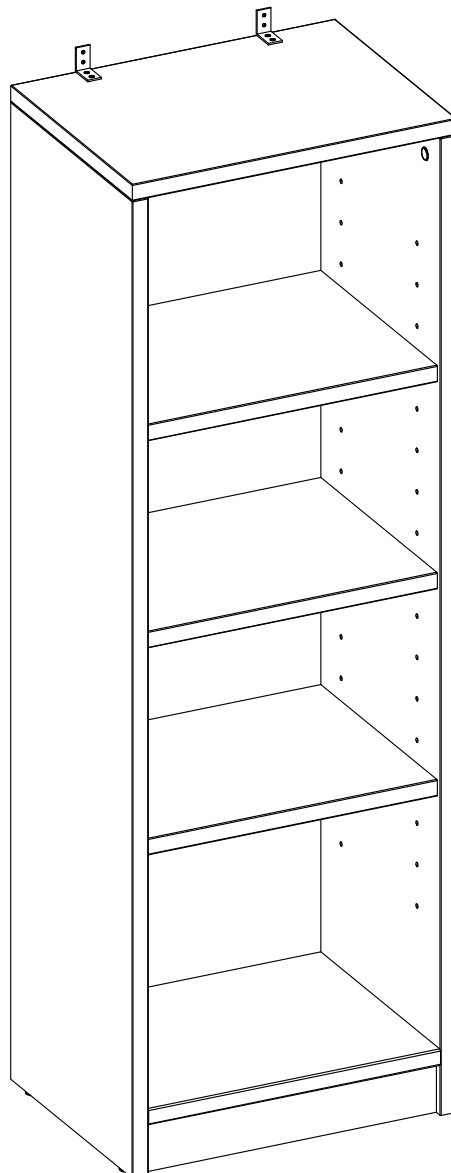

ERST-HOLZ[®] - die Marke für gute Holzprodukte

Steinhaus Handelsgesellschaft mbH & Co KG - Schauerödstr. 21 - 94152 Neuhaus - Tel.: 0 8503 924540

E-Mail: auftrag@erst-holz.de

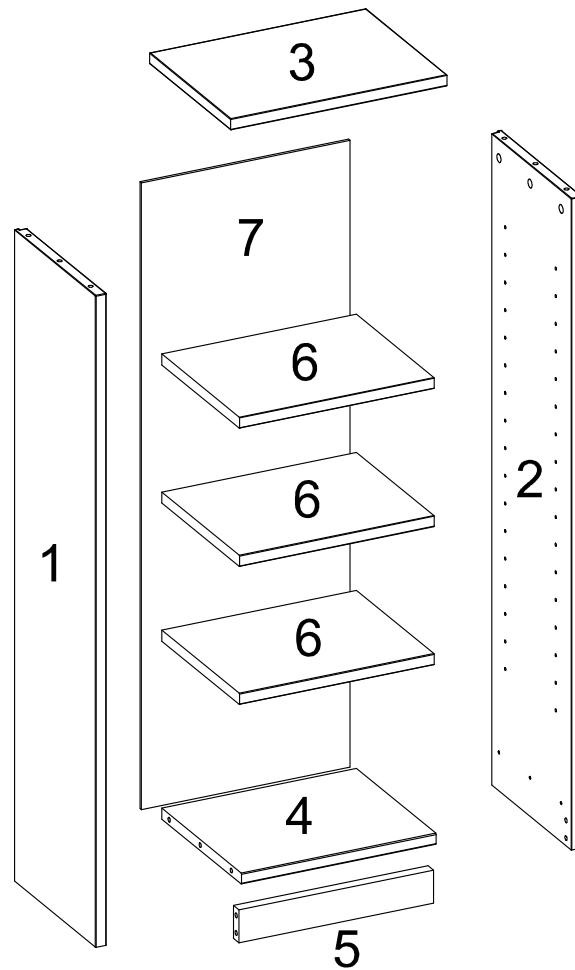

Bevor Sie die Schrauben, Dübel, Muttern in die dafür vorgesehenen Löcher stecken, prüfen Sie, ob sich gegebenenfalls noch Holzspäne in den Löchern befinden.

Achtung!





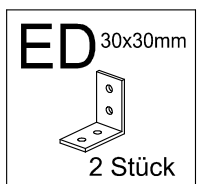
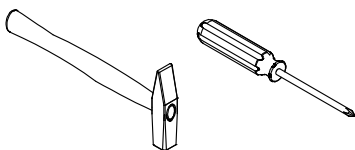
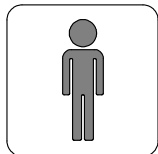

Alle Möbelstücke, die Höher als 60 cm sind, müssen an der Wand befestigt werden, um ein Kippen zu verhindern.

Befestigungsmaterial gehört nicht zum Lieferumfang, da die örtlichen Bedingungen sehr verschieden sind.

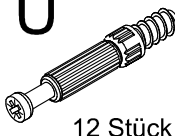
Teile-Nr.	Bezeichnung	Anzahl
1	linke Seitenwand	1
2	rechte Seitenwand	1
3	Oberteil	1
4	Unterteil	1
5	Sockelblende	1
6	Böden	3
7	Rückwand	1

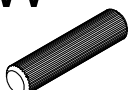
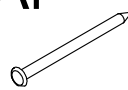
Sie benötigen zum Aufbau:

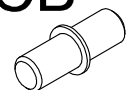

S Ø3,0x16mm  4 Stück	U  12 Stück	V Ø12x15mm  12 Stück	W Ø8x35mm  4 Stück	AF  22 Stück	BU  4 Stück	CB  12 Stück	DA Abdeckkappen  6 Stück
---	---	--	--	--	---	--	--

1

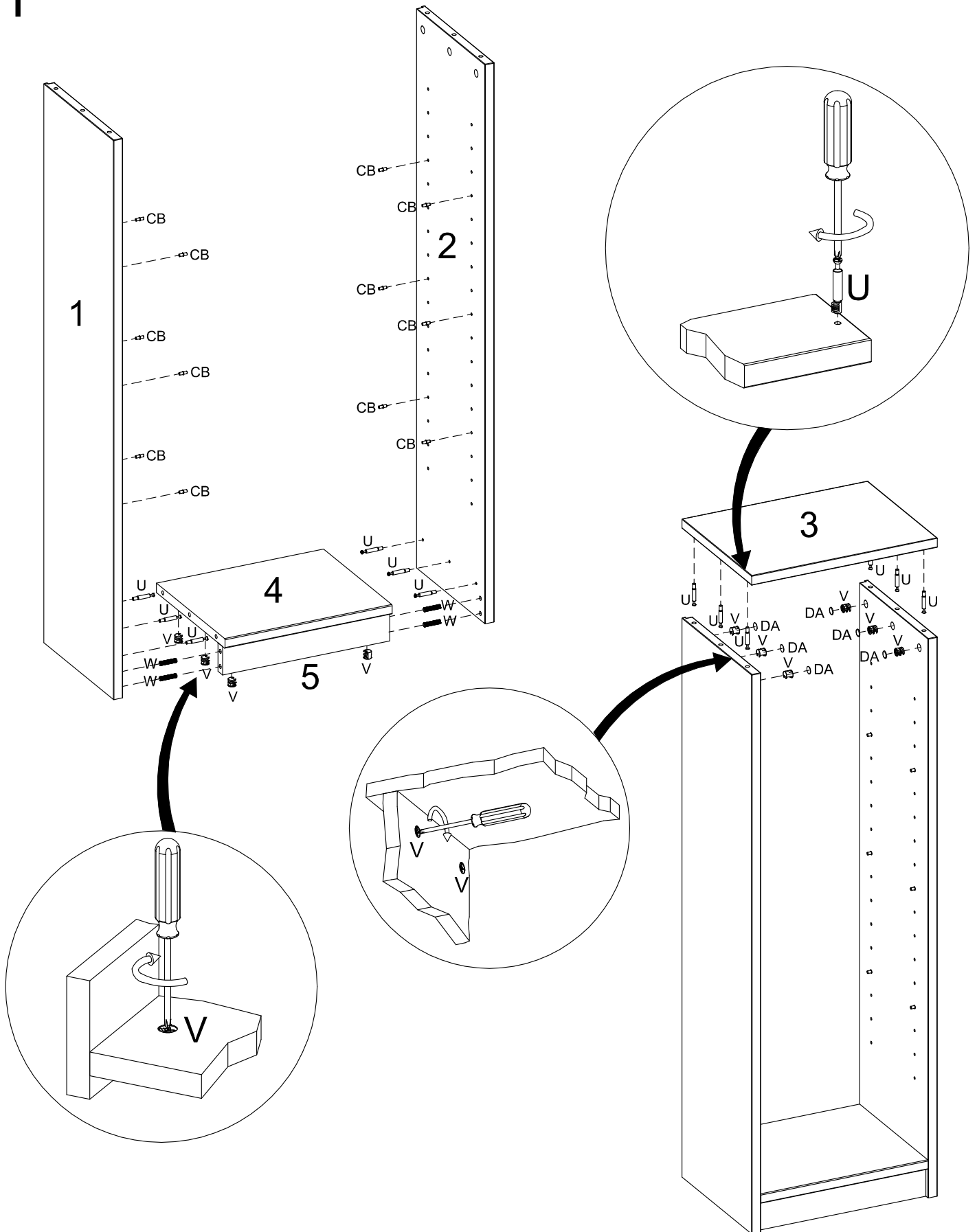

2

