

15'

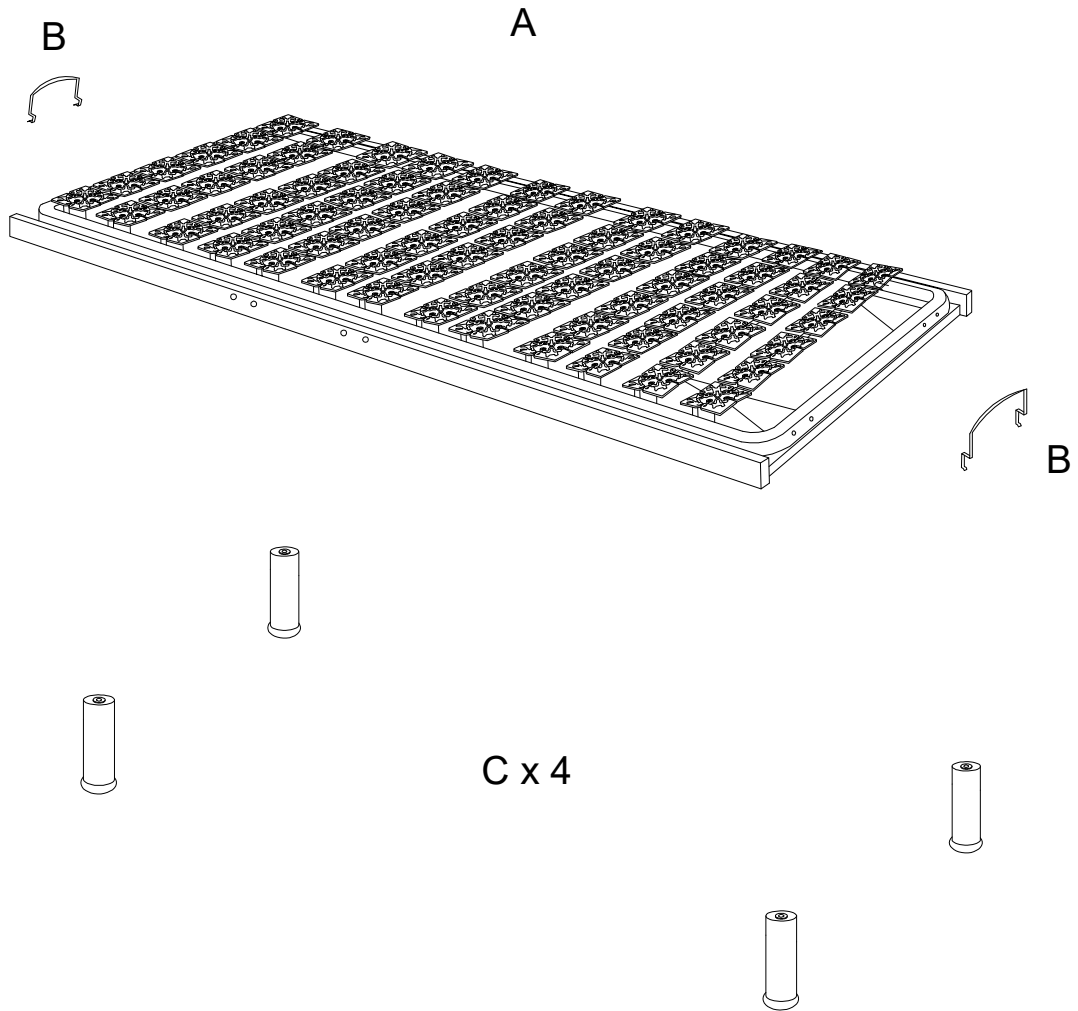

1

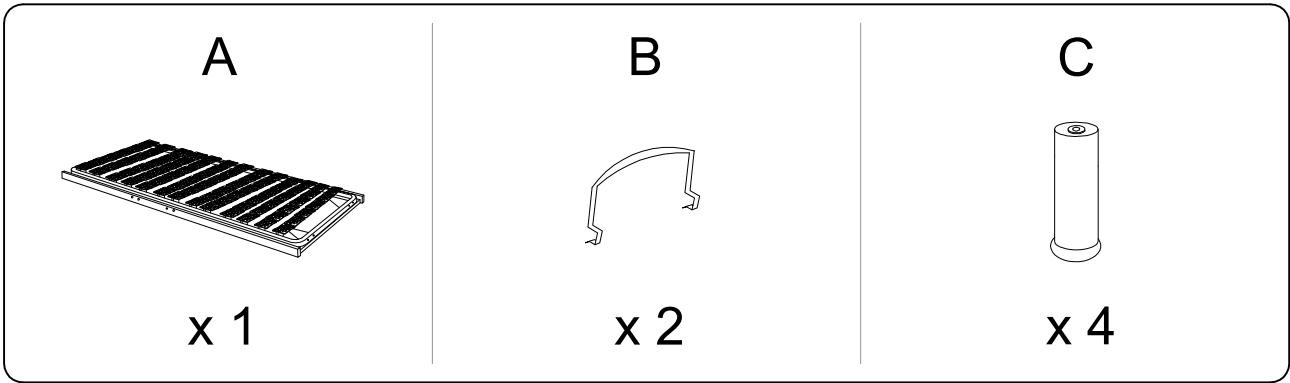

1

C  
x 4

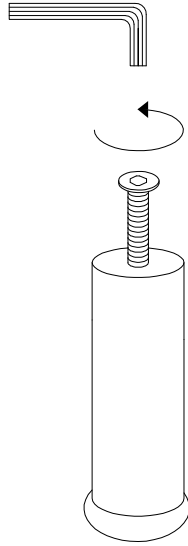

2

A  
x 1

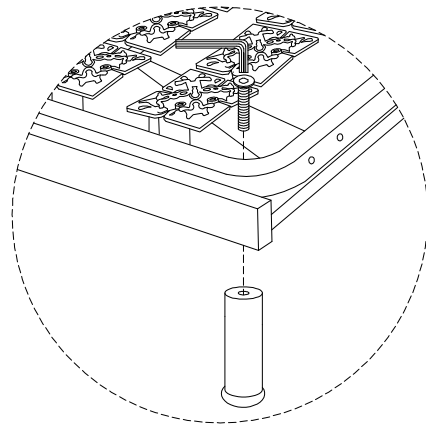
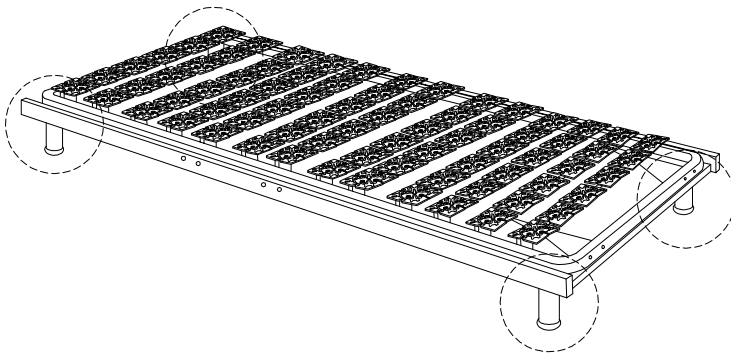
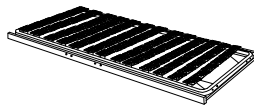

3

B

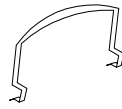

x 2

