

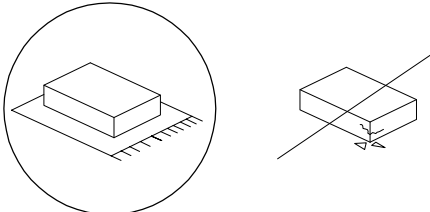





		30'
		
		1

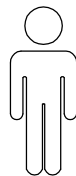
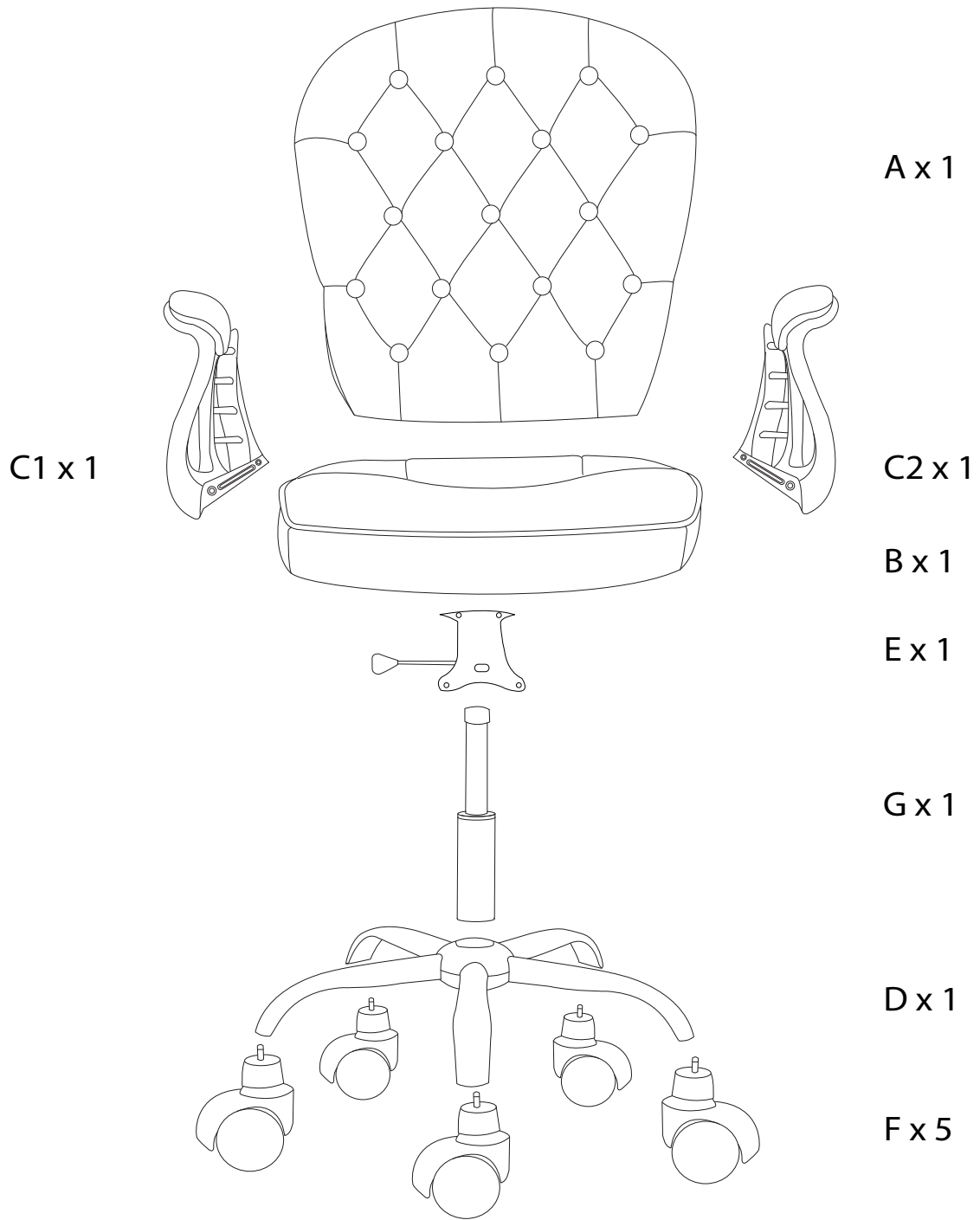
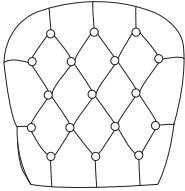
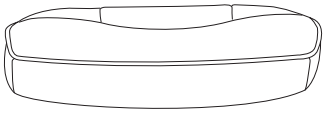

A  x 1	B  x 1	C1  x 1
---	---	--

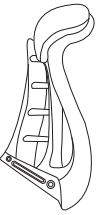
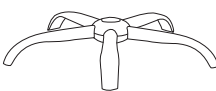
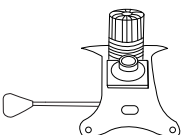
<p>C2</p>  <p>x 1</p>	<p>D</p>  <p>x 1</p>	<p>E</p>  <p>x 1</p>	<p>F</p>  <p>x 5</p>	<p>G</p>  <p>x 1</p>
<p>H</p>  <p>M6 x 30</p> <p>x 8</p>	<p>I</p>  <p>M6 x 20</p> <p>x 4</p>	<p>J</p>  <p>x 8</p>	<p>K</p>  <p>x 1</p>	<p>L</p>  <p>x 4</p>

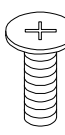
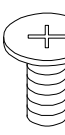
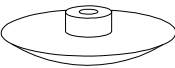
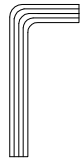
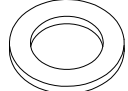
1

D

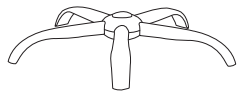

x 1

F



x 5

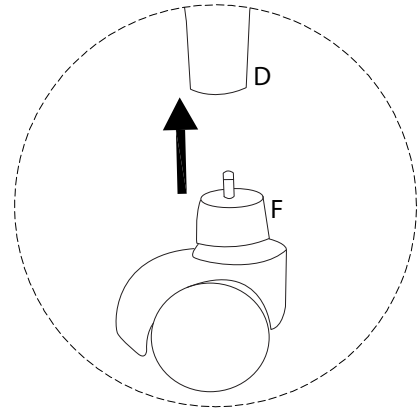
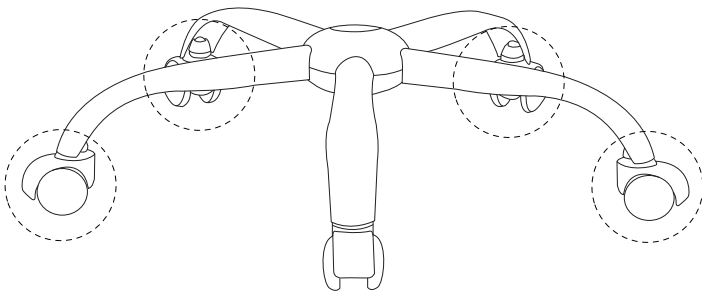

2

B

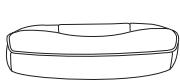

x 1

E

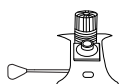

x 1

I



x 4

K



x 1





L

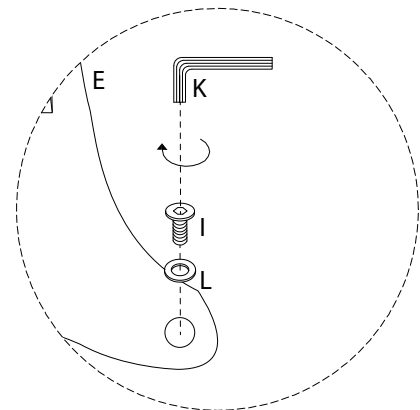
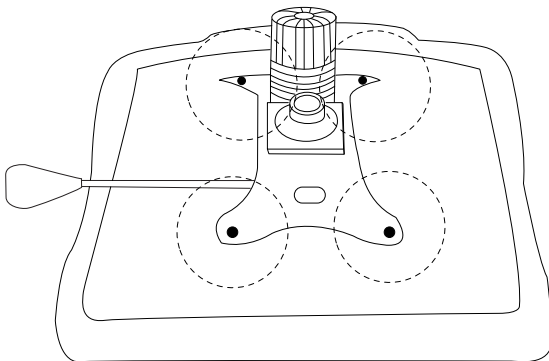

x 4

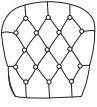

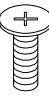
3

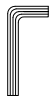
A  x 1	C1  x 1	C2  x 1	H  M6 x 30 x 8	J  x 8	K  x 1
--	---	---	--	--	--

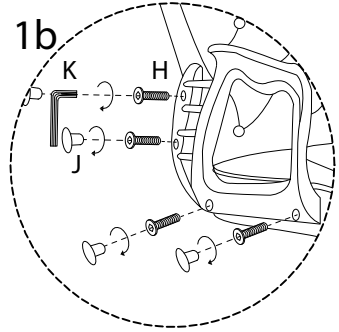
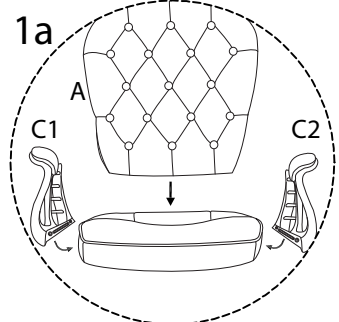
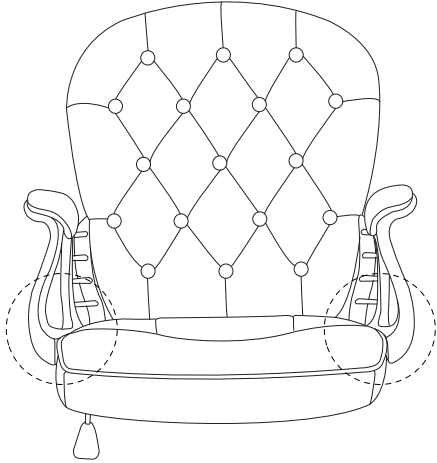

4

G  x 1
--

