











A		M6*100	4
B		M6*80	14
C			18
D		Φ8*30	24
E		Φ6*80	12
F		Φ6*100	10
G		4*30	20
H		4 mm	1

STEP:1



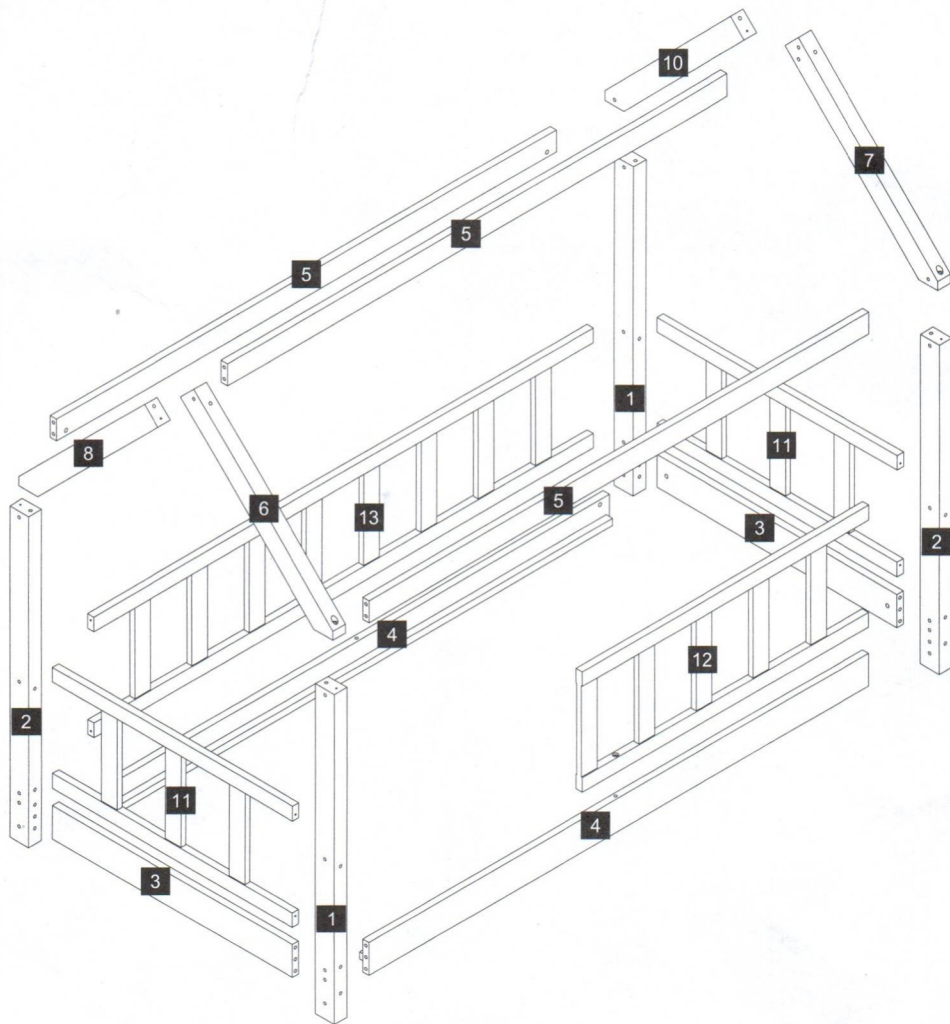

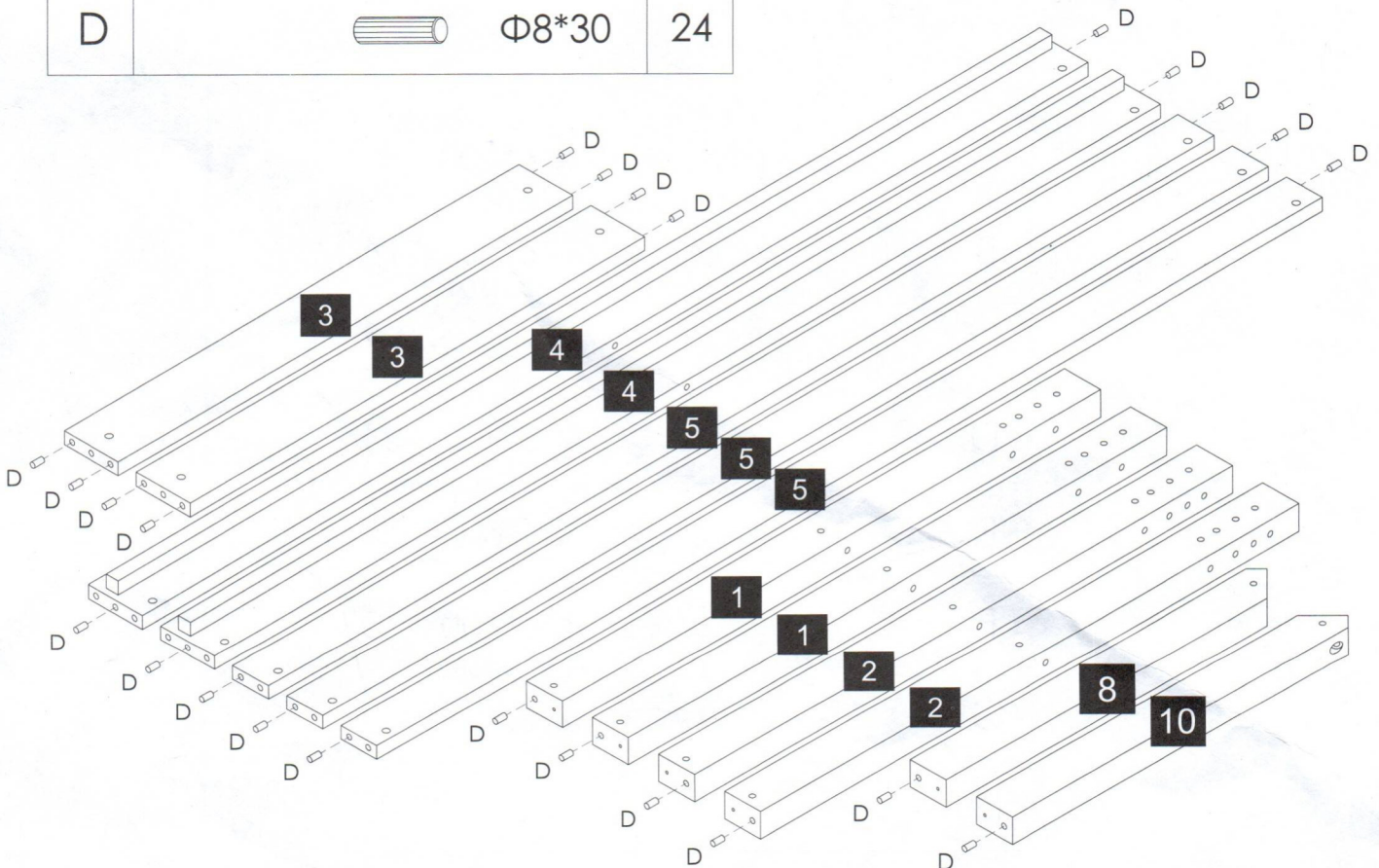

STEP:2

D		$\Phi 8*30$	24
---	---	-------------	----

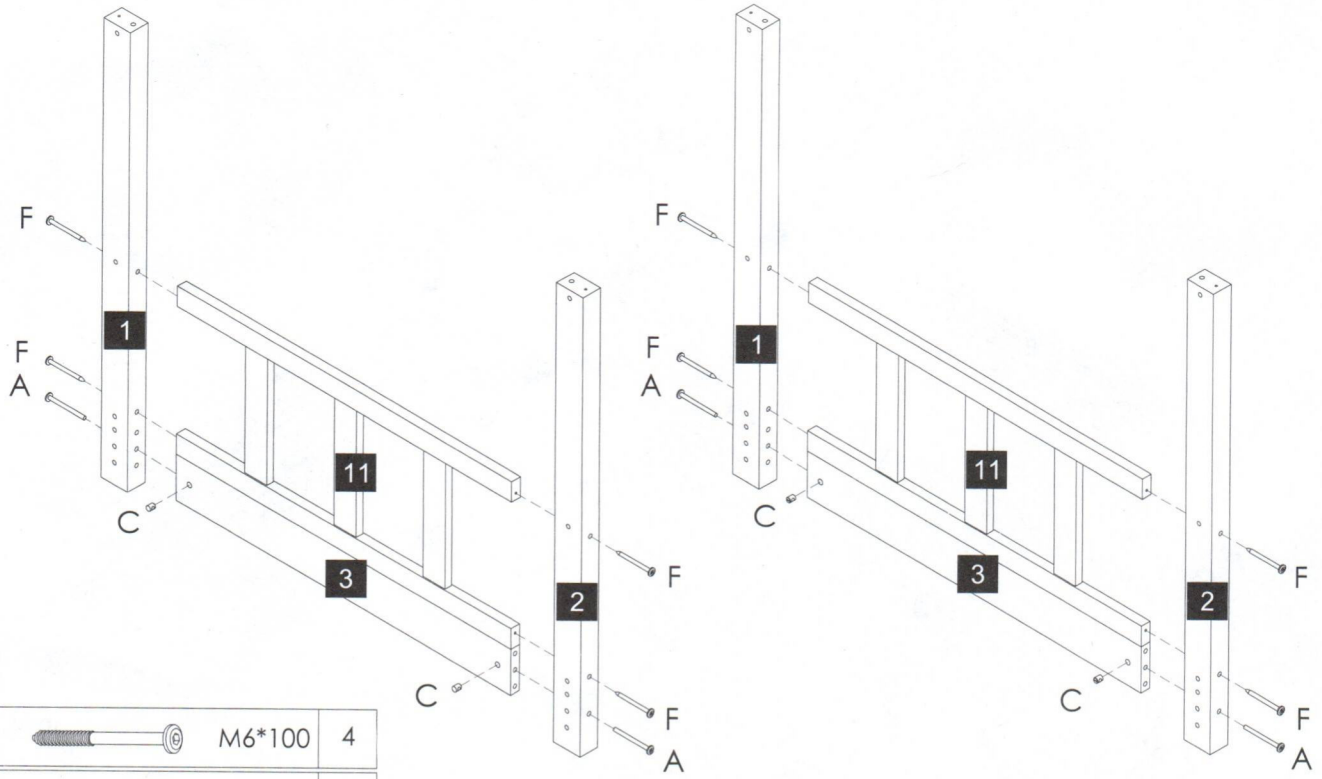



STEP:3

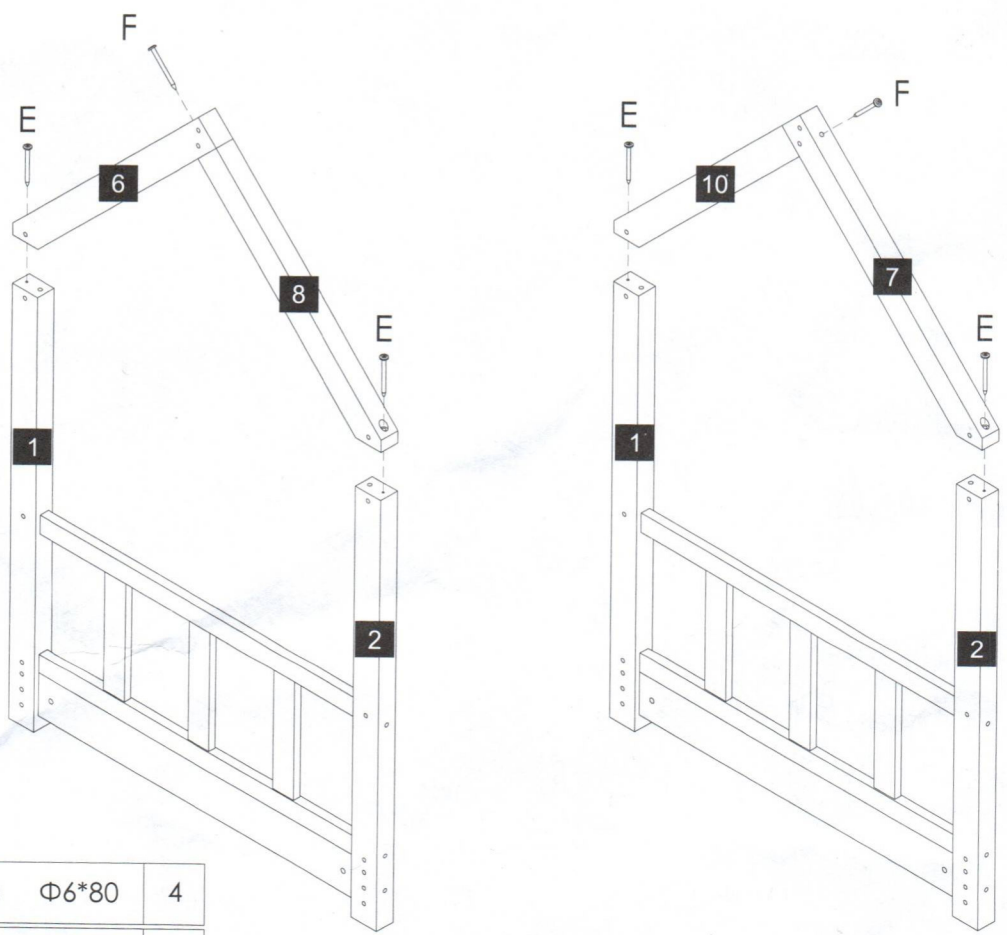

A		M6*100	4
C			4
F		Φ6*100	8

STEP:4



E		Φ6*80	4
F		Φ6*100	2

STEP:5

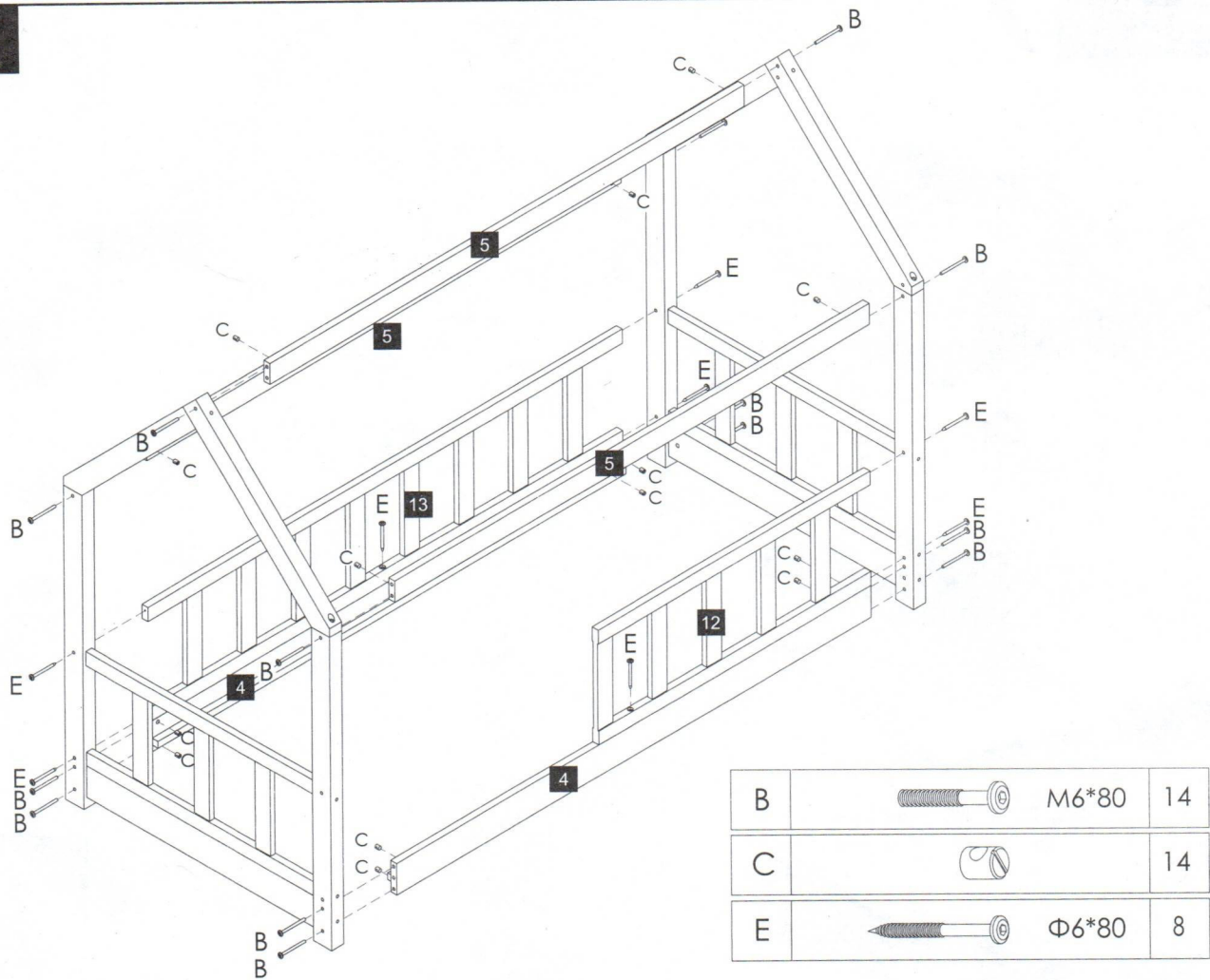

STEP:6

