









A		4*30	54
B		M6*40	18
C			2
D		Φ8*30	16
E		Φ7*60	4
F		M6*60	6
G		M6*60	24
H			1





### STEP:1

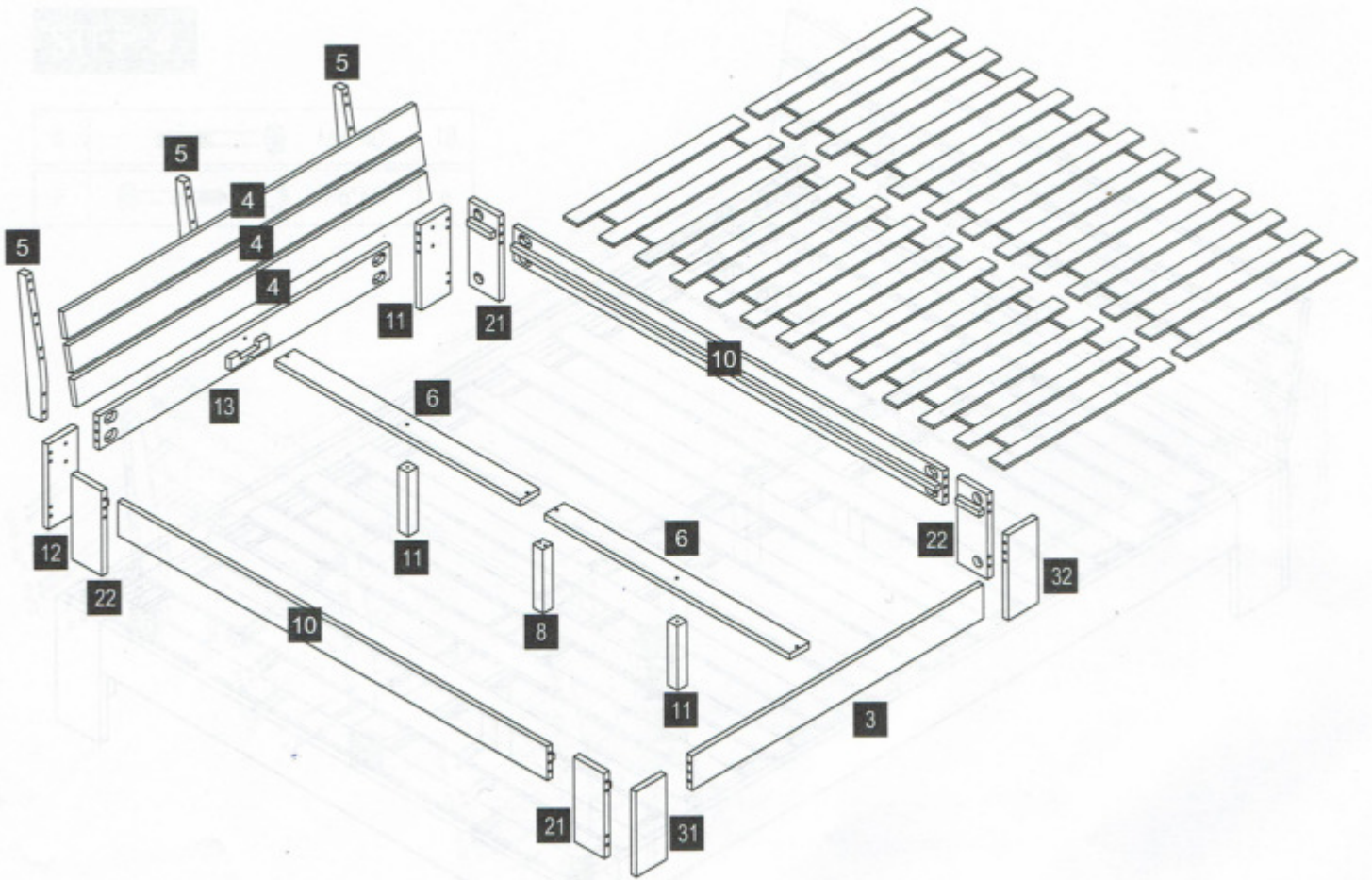
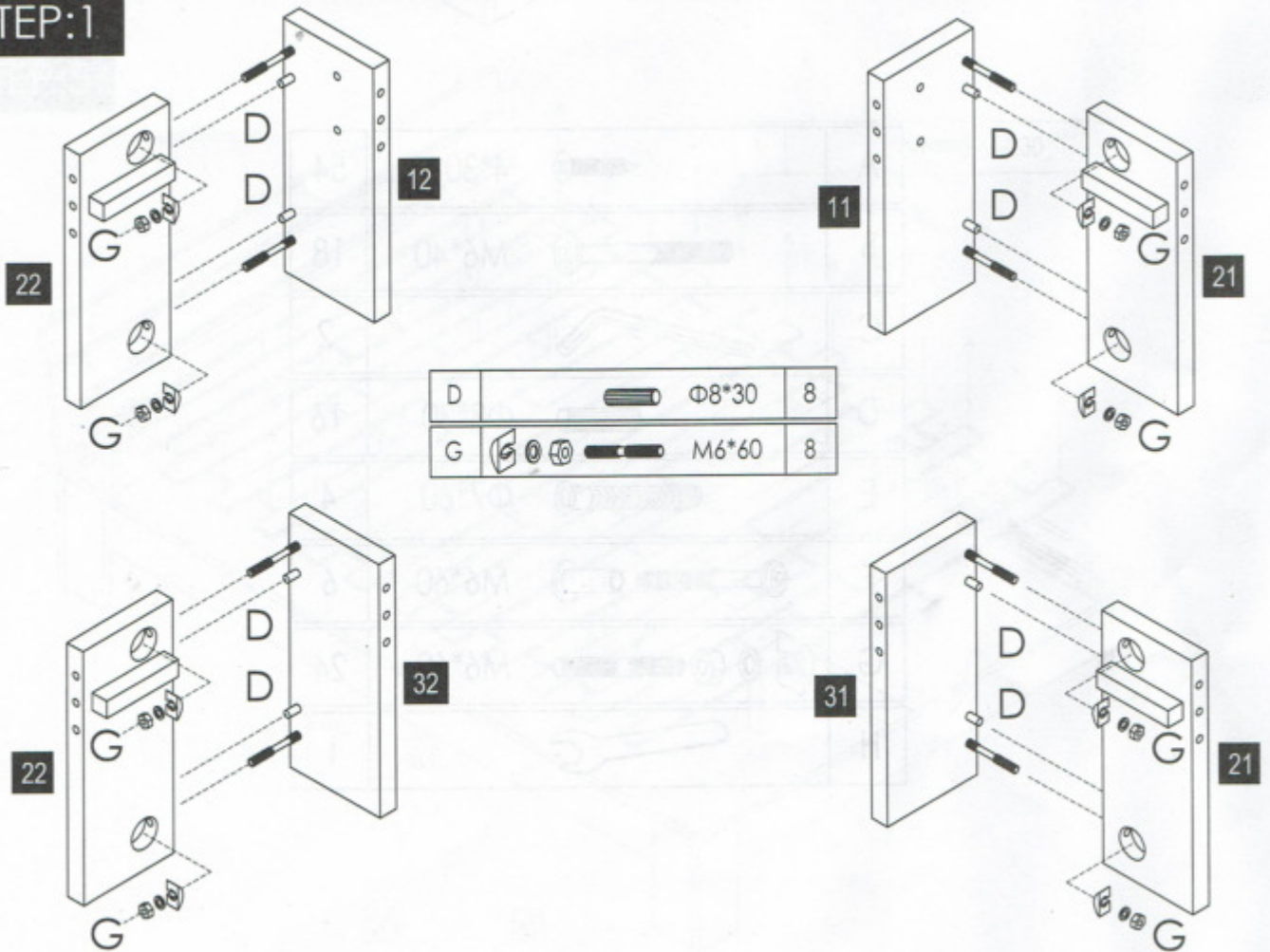



## STEP:2

D		Φ8*30	4
G		M6*60	8

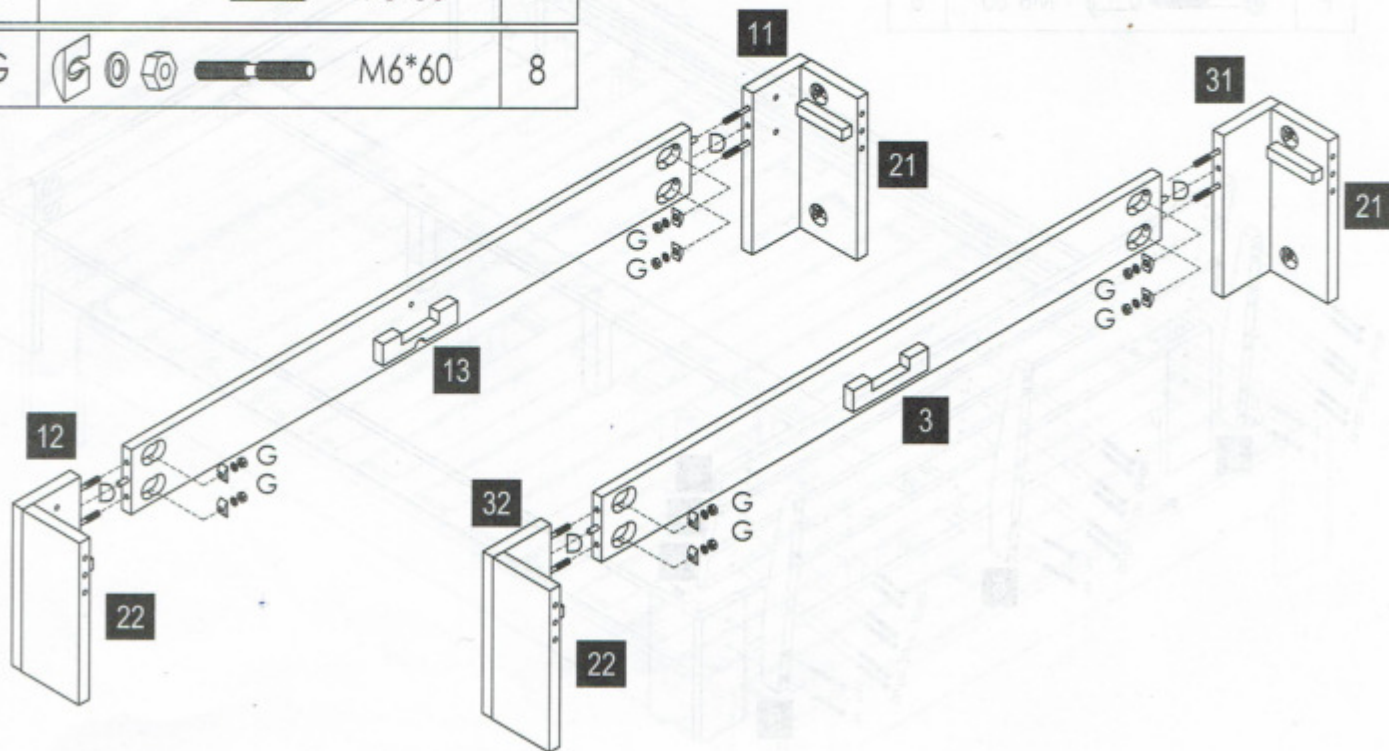

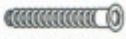
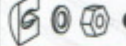

## STEP:3

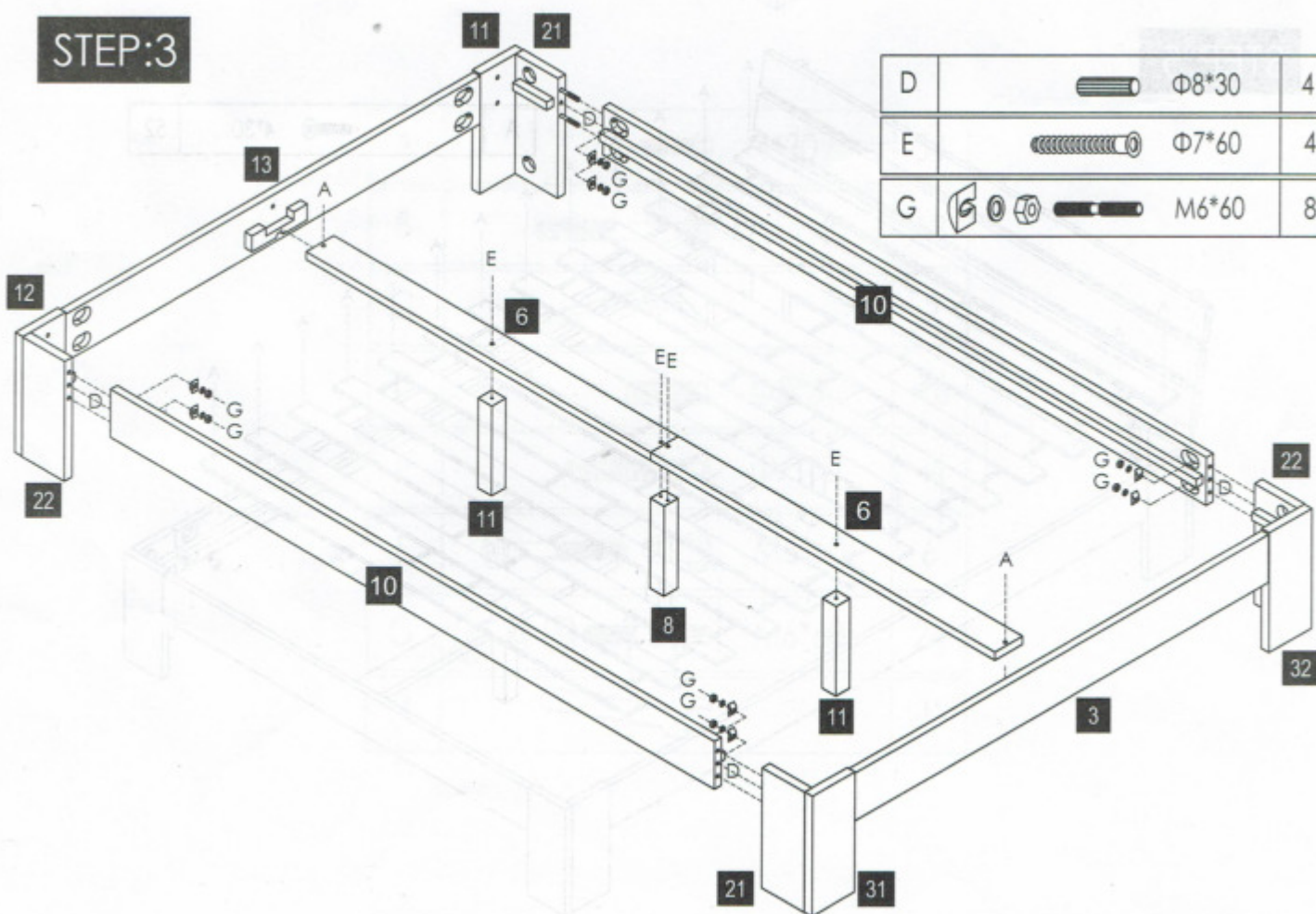
D		Φ8*30	4
E		Φ7*60	4
G		M6*60	8





# STEP:4

B		M6*40	18
F		M6*60	6

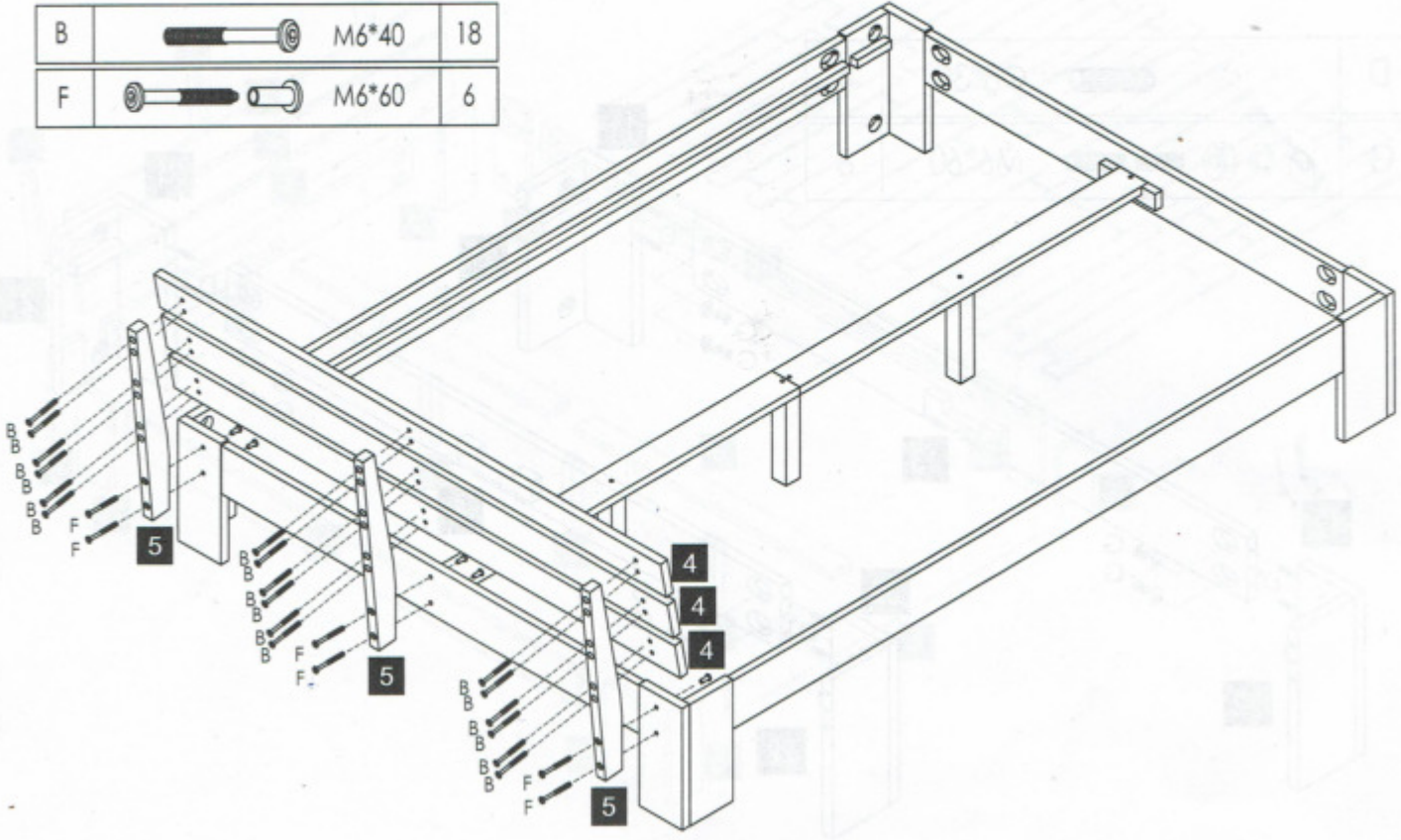

# STEP:5

A		4*30	52
---	---	------	----

