

20'

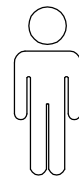

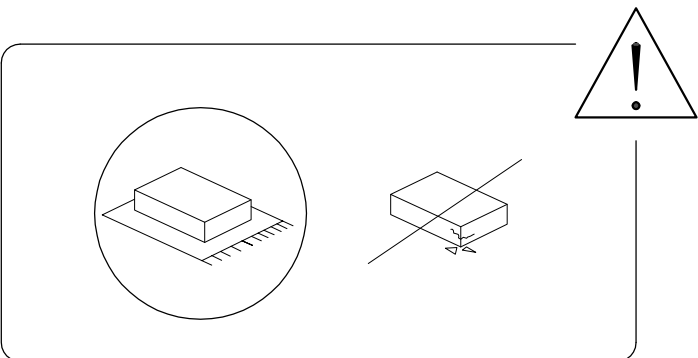
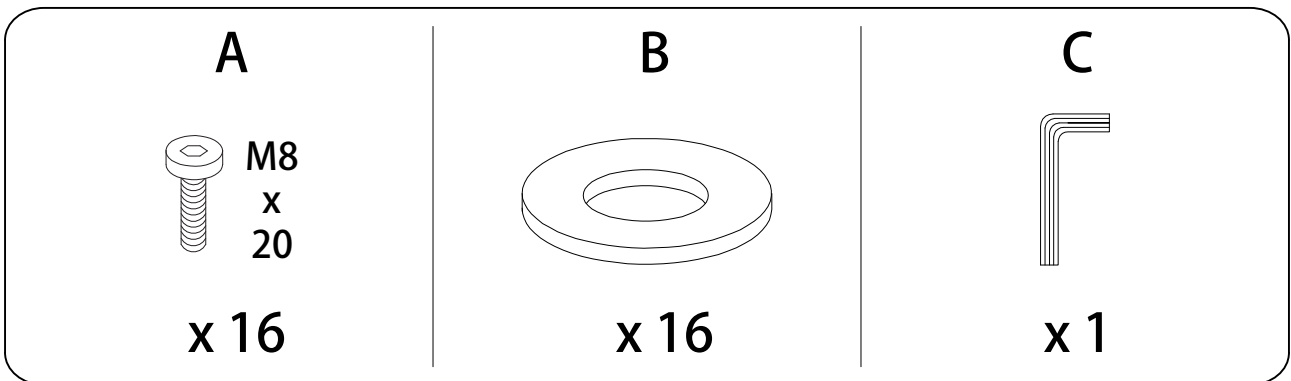
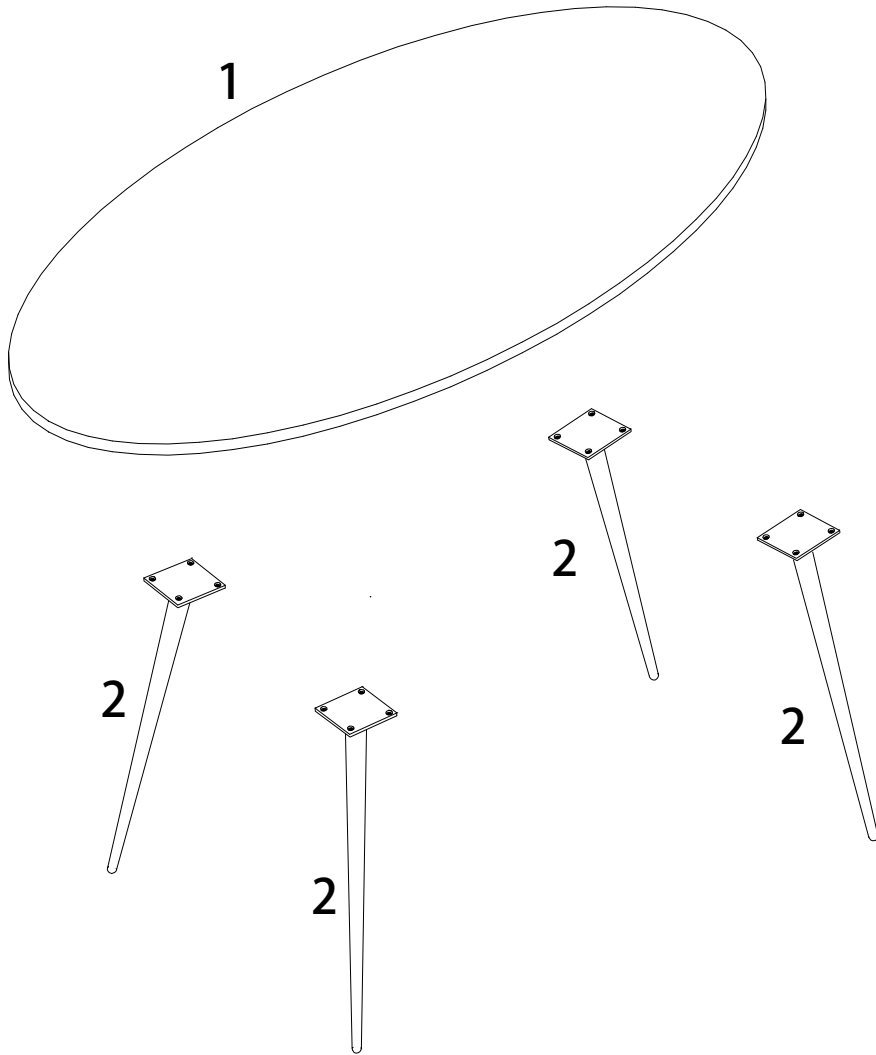
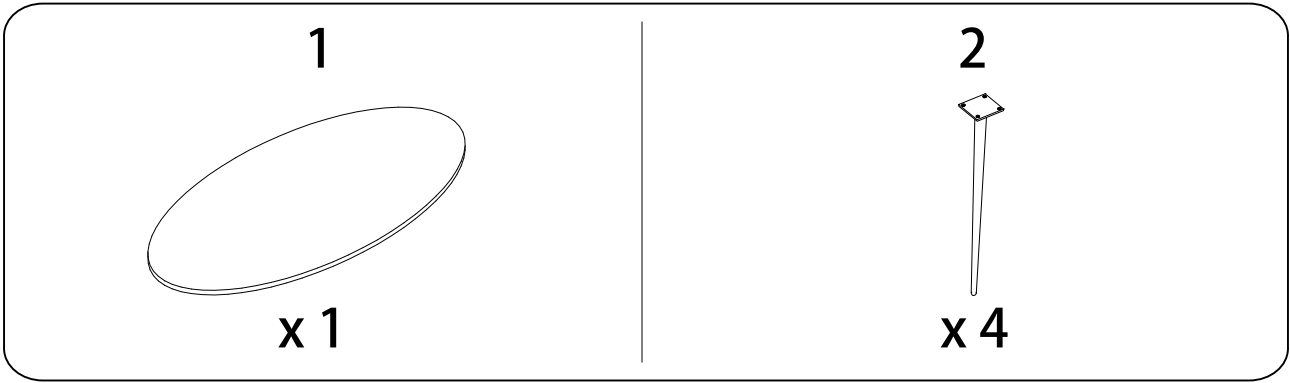

2

1/3

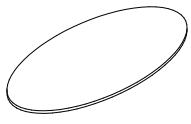

1

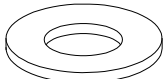
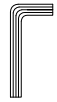
| | | | | |
|---|---|--|--|---|
| <p>1</p>  <p>x 1</p> | <p>2</p>  <p>x 4</p> | <p>A</p>  <p>M8 x 20 x 16</p> | <p>B</p>  <p>x 16</p> | <p>C</p>  <p>x 1</p> |
|---|---|--|--|---|

