

ANNIKA

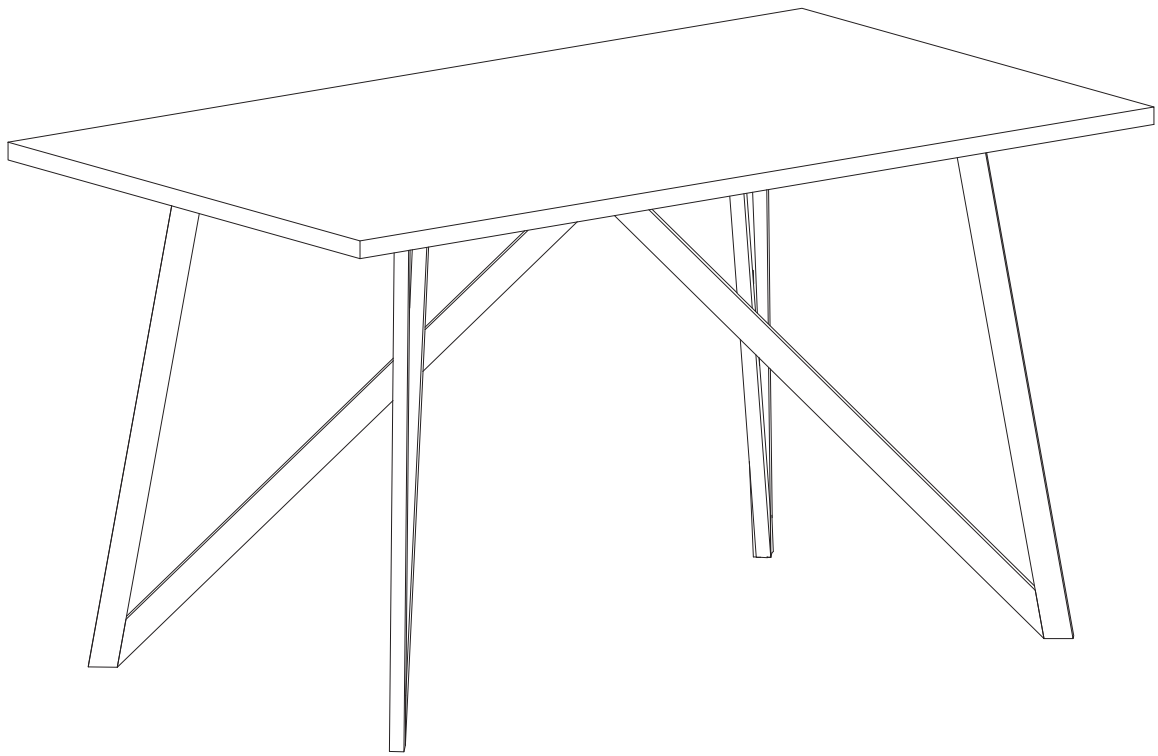

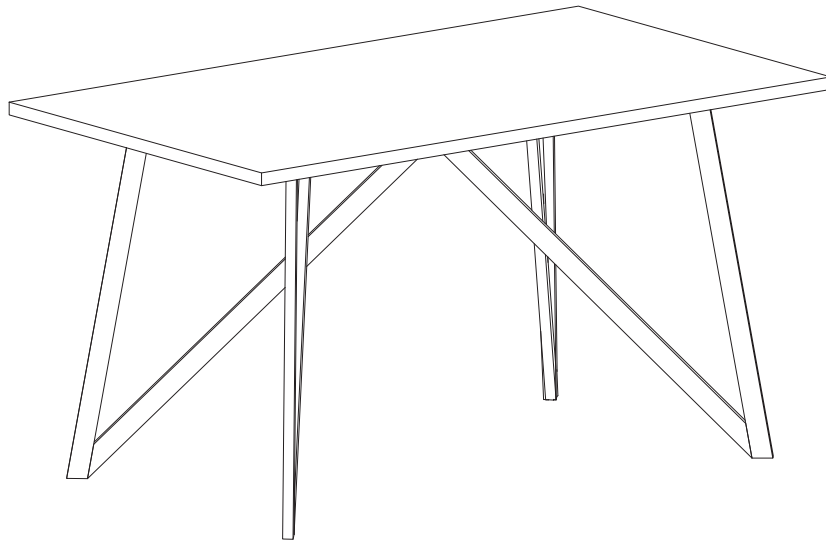
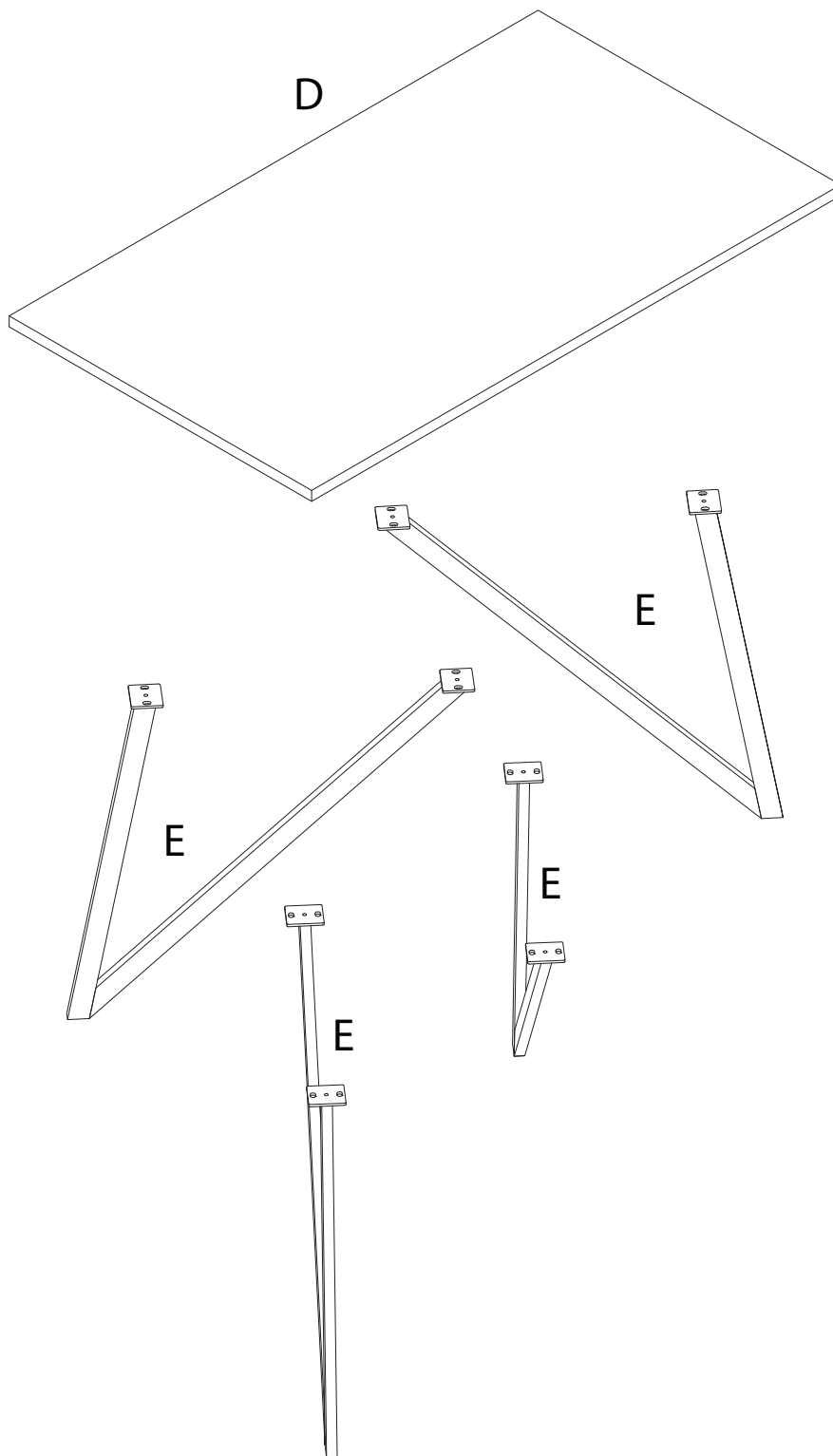
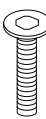
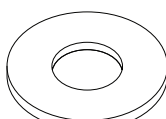

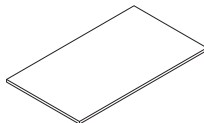
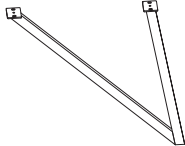



Diagram illustrating assembly instructions and safety warnings:

- Warning 1:** A warning triangle with an exclamation mark is shown next to a box containing an L-shaped bracket and a power drill with a slash through it, indicating that a power drill should not be used for this step.
- Warning 2:** A second warning triangle with an exclamation mark is shown next to a box containing a rectangular block being placed on a surface and a diagram showing a block being secured with a screw.
- Time:** A clock icon is shown next to the text "20'", indicating the estimated assembly time.
- Personnel:** An icon of a person is shown next to the number "2", indicating that two people are required for assembly.



A	B	C	D	E
 M8 x 25				
x 16	x 16	x 1	x 1	x 4

1

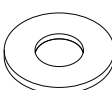
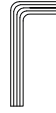
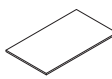
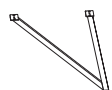
A  M8 x 25 x 16	B  x 16	C  x 1	D  x 1	E  x 4
--	---	--	--	--

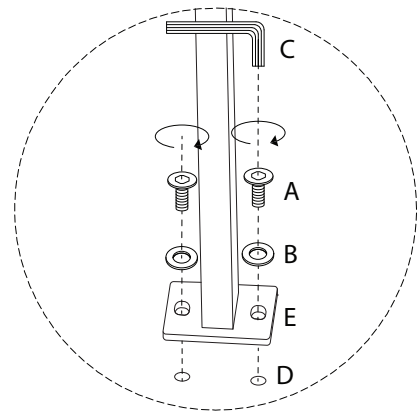
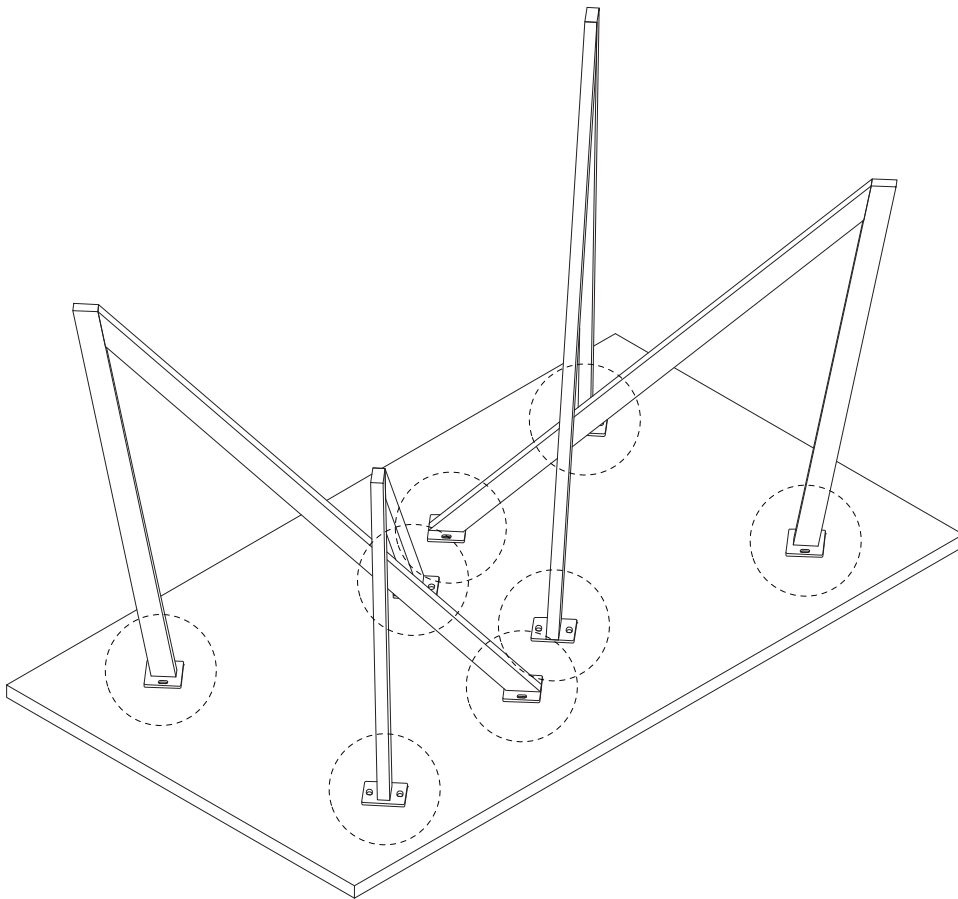

!

