

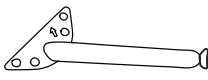

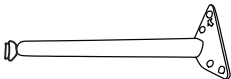

CH-1728350-1

| PARTIDENTIFICATION | QUANTITYPERSET | PARTIDENTIFICATION | QUANTITYPERSET |
|--|----------------|---|----------------|
| 1:  | 1 | 5:  | 1 |
| 2:  | 1 | A:  M6x20 | 16 |
| 3:  | 1 | B:  M5 | 1 |
| 4:  | 1 | | |

1

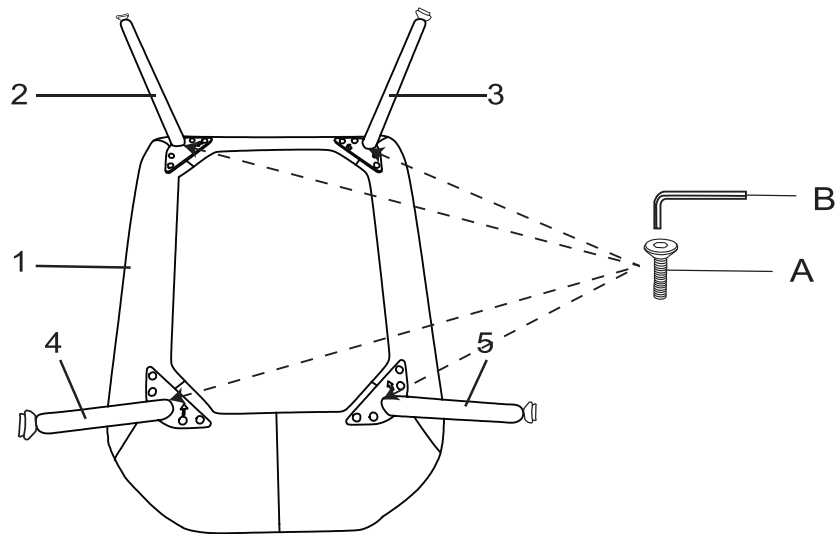

2

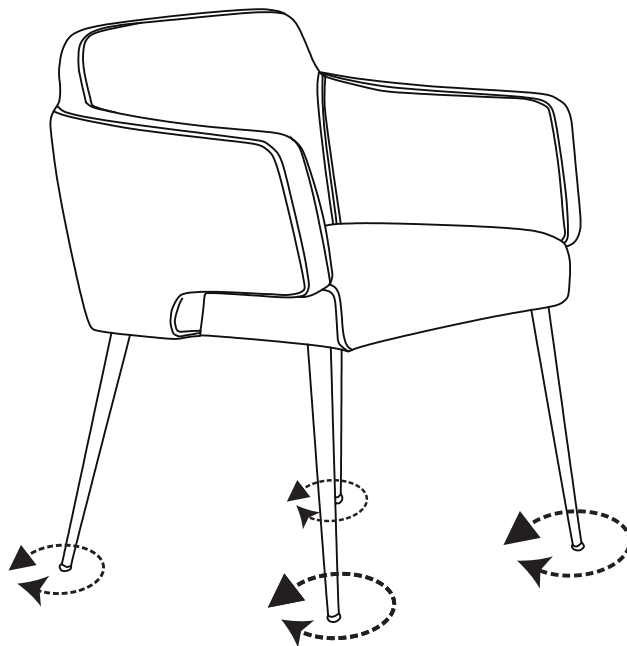

please adjust foot cap if chair is not flat after assembled

Sollte das Sitzmöbel nicht gerade stehen, kann das über die Stellfüße angepasst werden.

Si le siège n'est pas droit, il est possible de l'ajuster grâce aux pieds réglables.

Se il mobile non sta in piedi, può essere regolato tramite i piedini regolabili.

Si el mueble de asiento no se mantiene erguido, puede ajustarse mediante los pies regulables.