

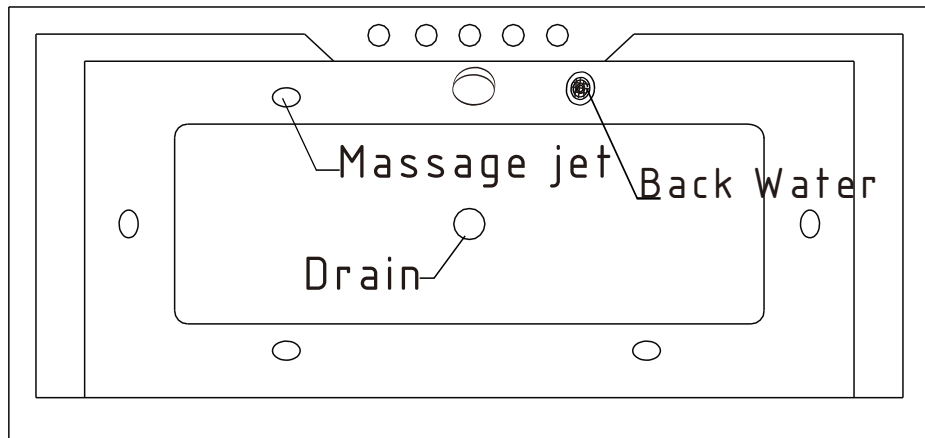

C-3098

1700x800x590 mm

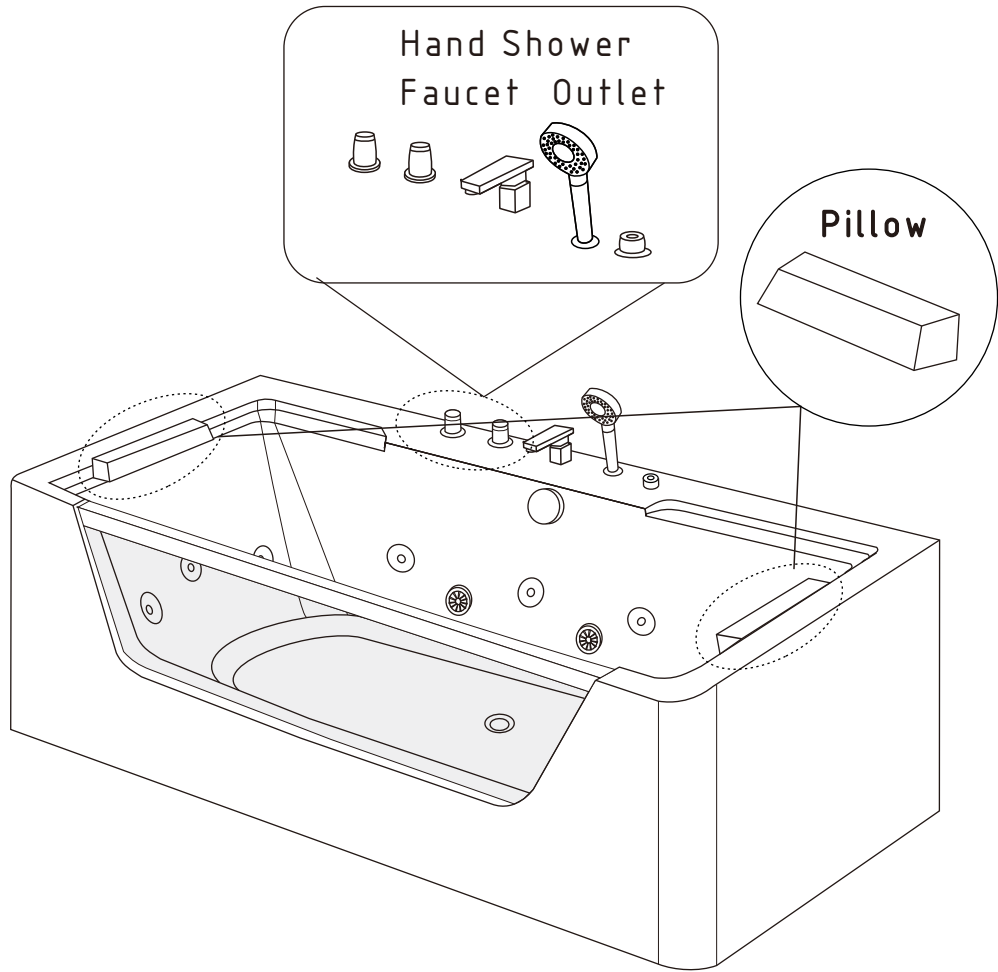

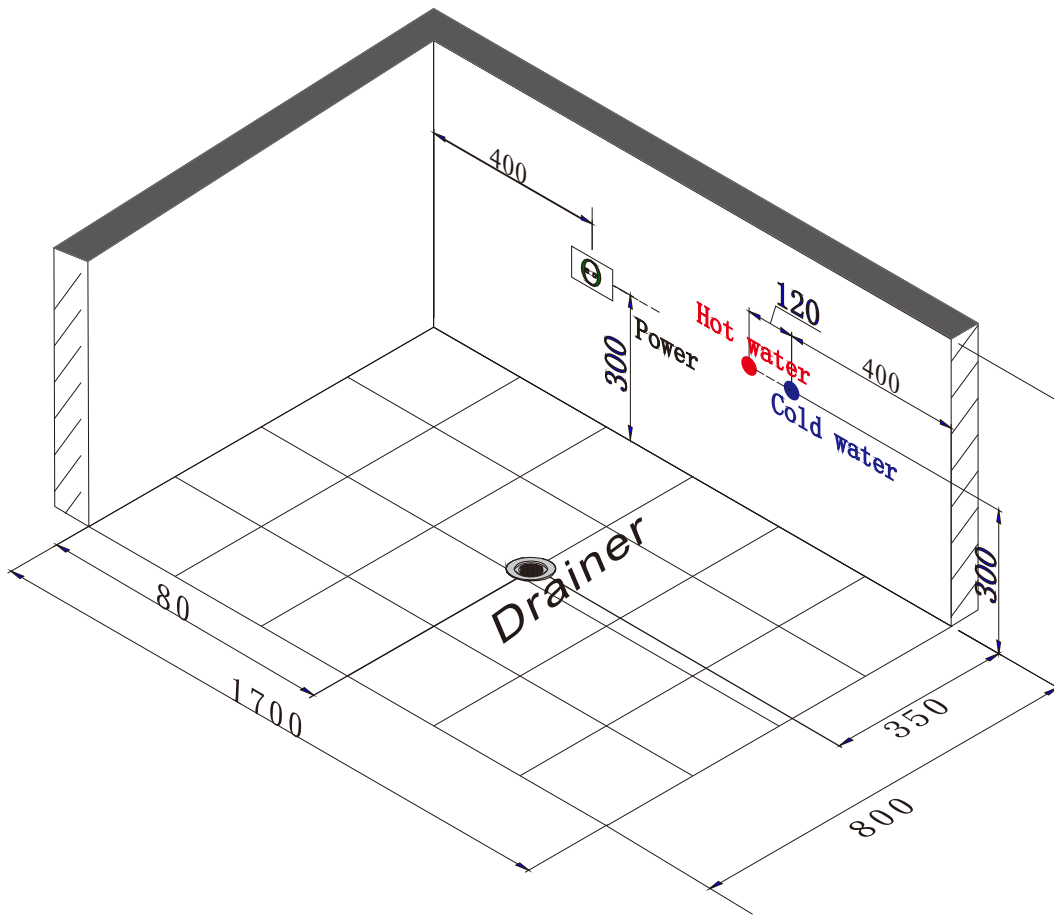

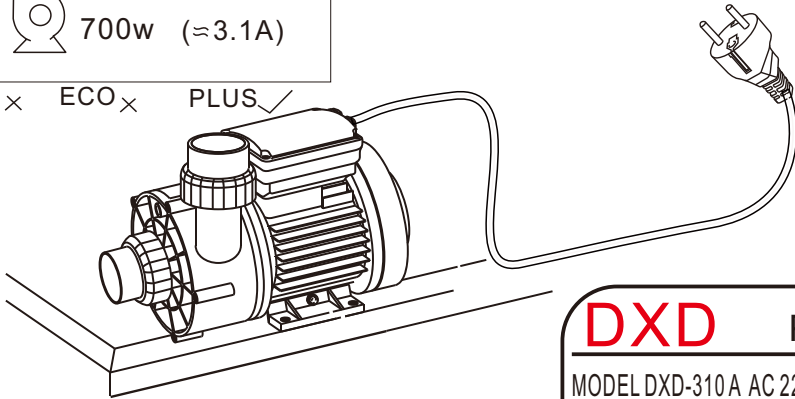

+  700w (≈3.1A)

VITAL  ECO  PLUS



**DXD PUMP**

MODEL DXD-310 A AC 220-240V 50Hz 700W CLASS B IPX5  
 MAX WATER TEMPERATURE 50C 15u F/450V Hmin 1m

**Mround properly!  
 Do Not Start Pump  
 Without Water!**

