

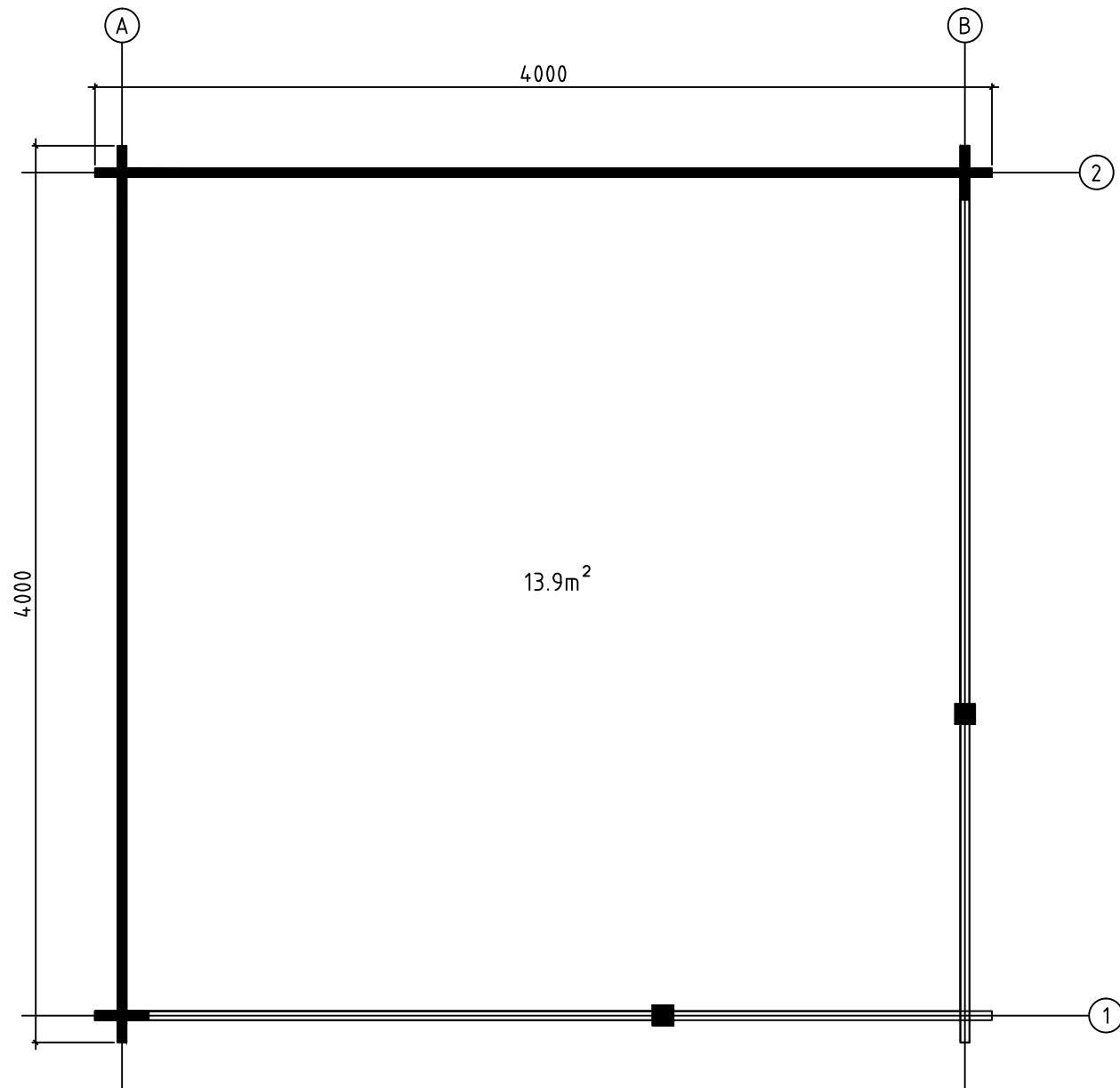



Maik40



Model	Maik40	Drawing	PLAN	Page
 www.gartenhaus-gmbh.de www.gartenhaus.at www.gartenhaus.ch +49 (0) 40 537 9978-50	Drawn by	R.Tamm	Material	40x114
	Date	20.04.2017	File	Maik40.dwg
			Scale	1:30

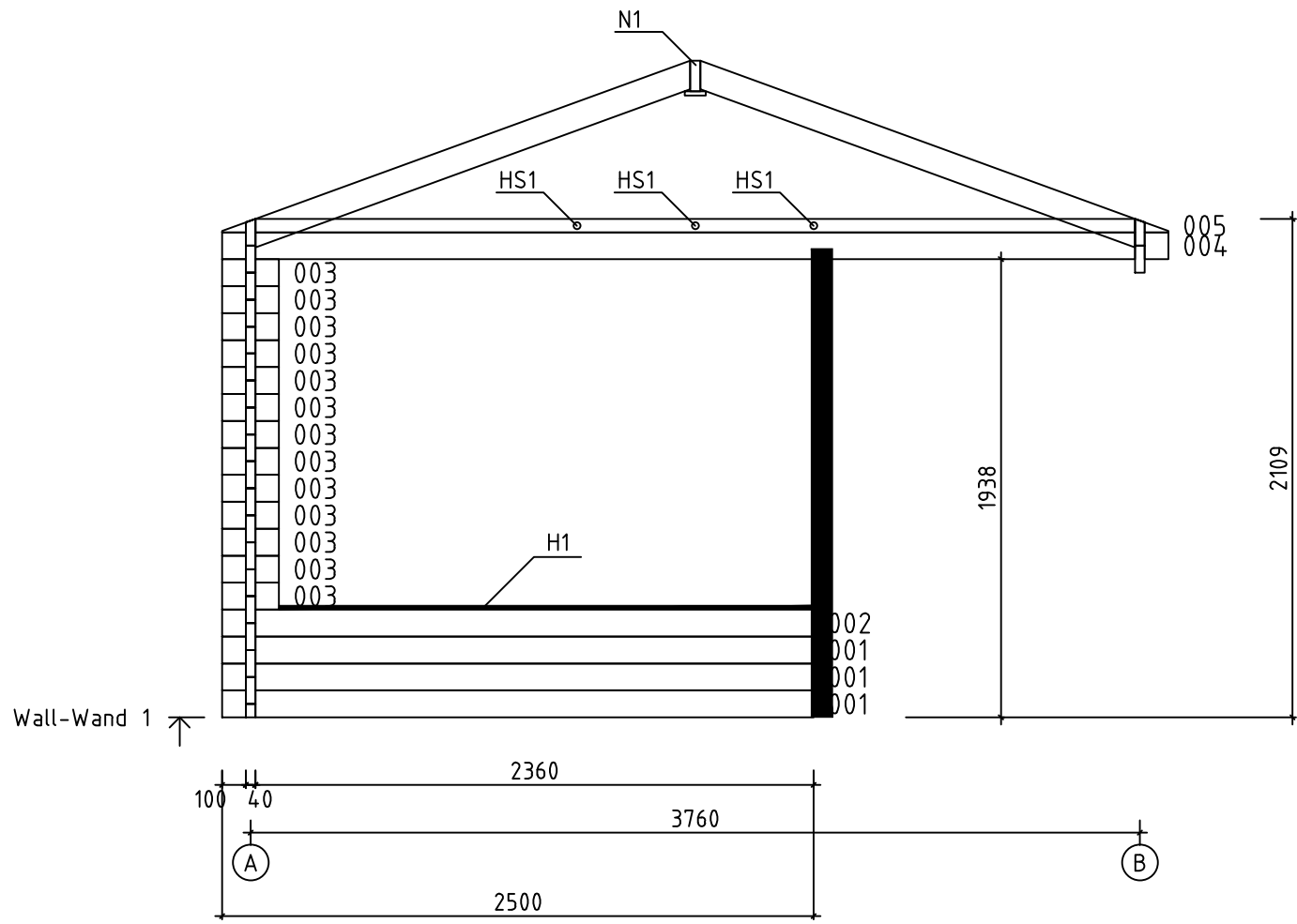

Model	Maik40	Drawing	WALL-WAND 1	Page	4	
 www.gartenhaus-gmbh.de www.gartenhaus.at www.gartenhaus.ch +49 (0) 40 537 9978-50	Drawn by	R.Tamm	Material	4x11.4	Scale	1:30
	Date	20.04.2017	File	Maik40.dwg		

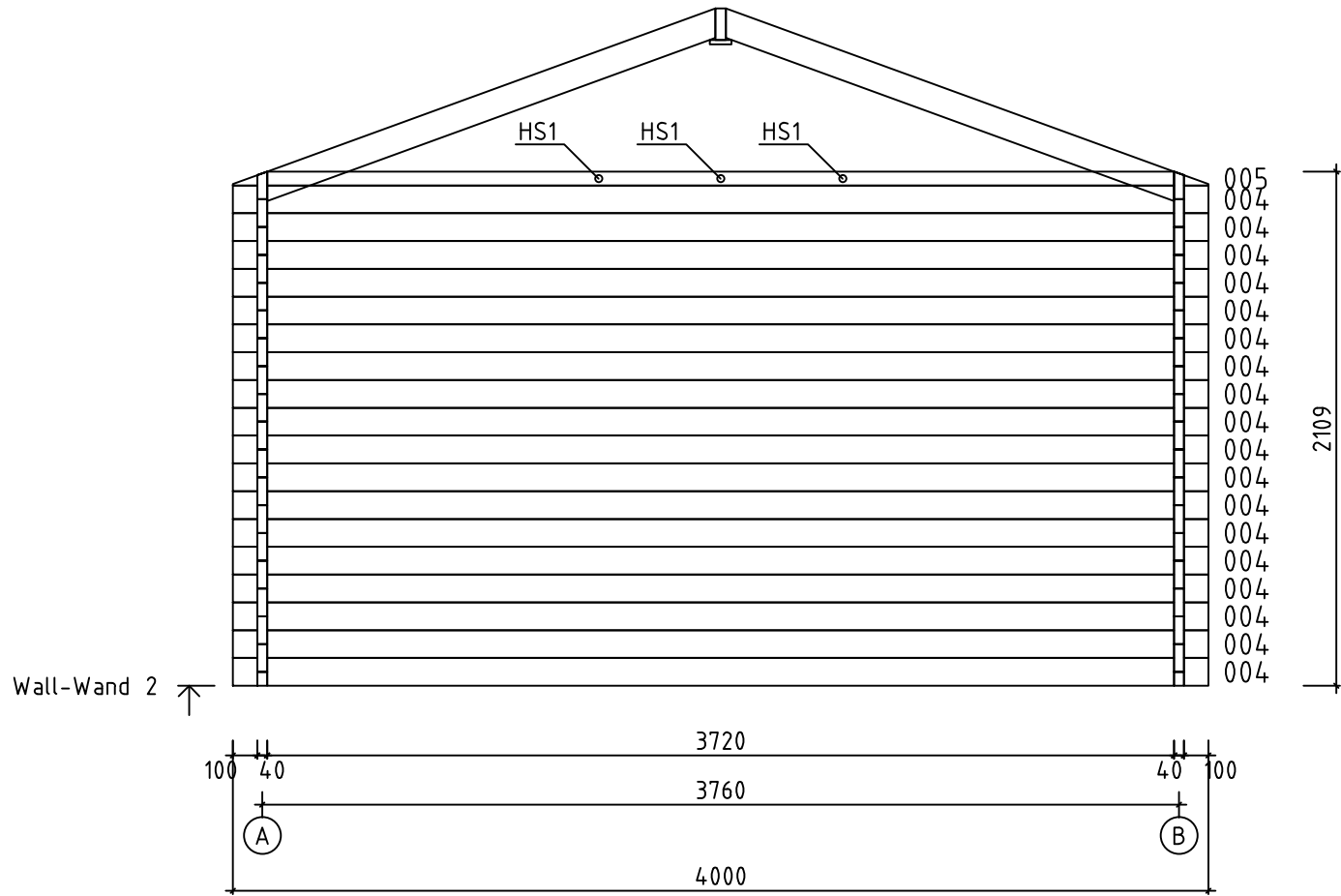



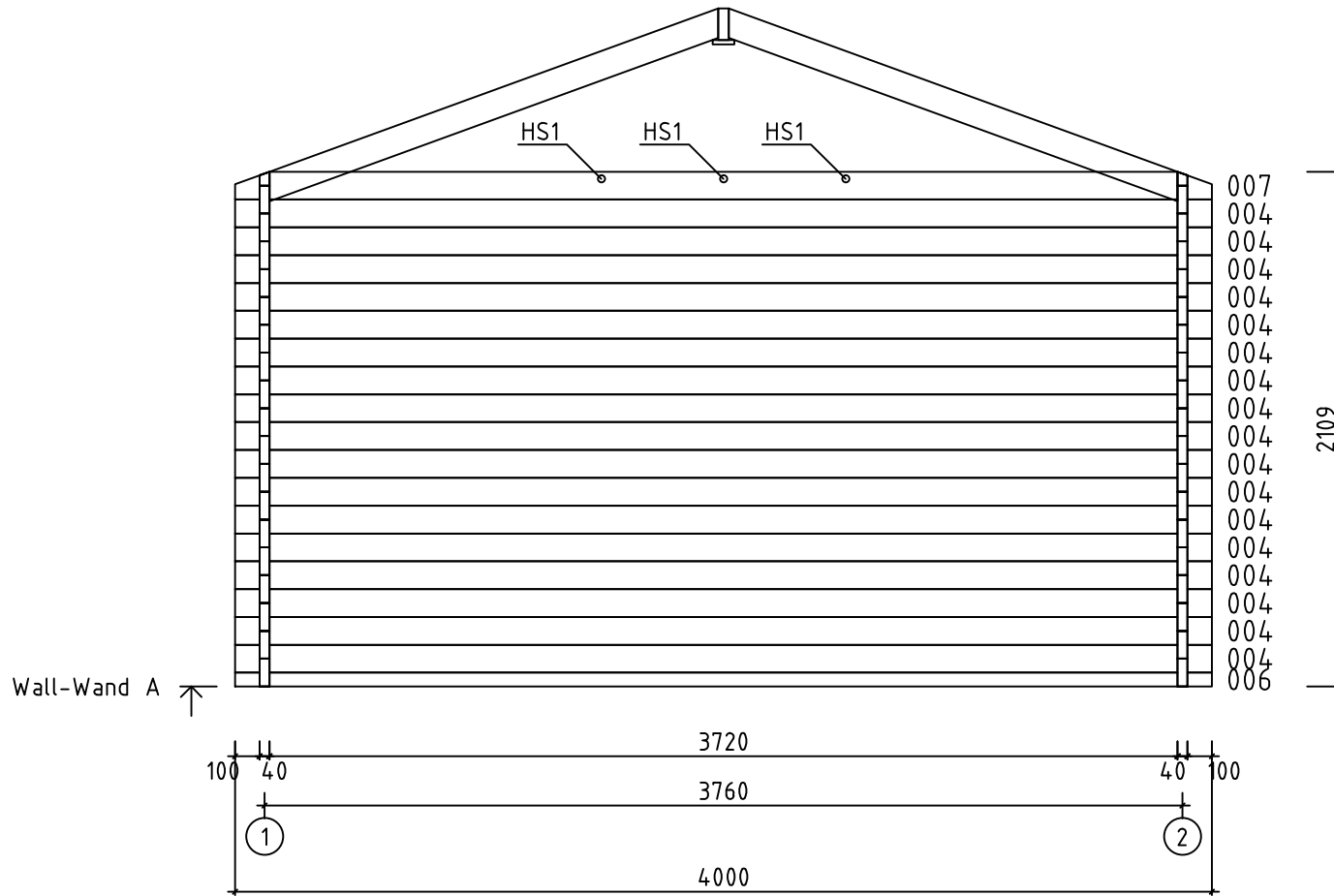



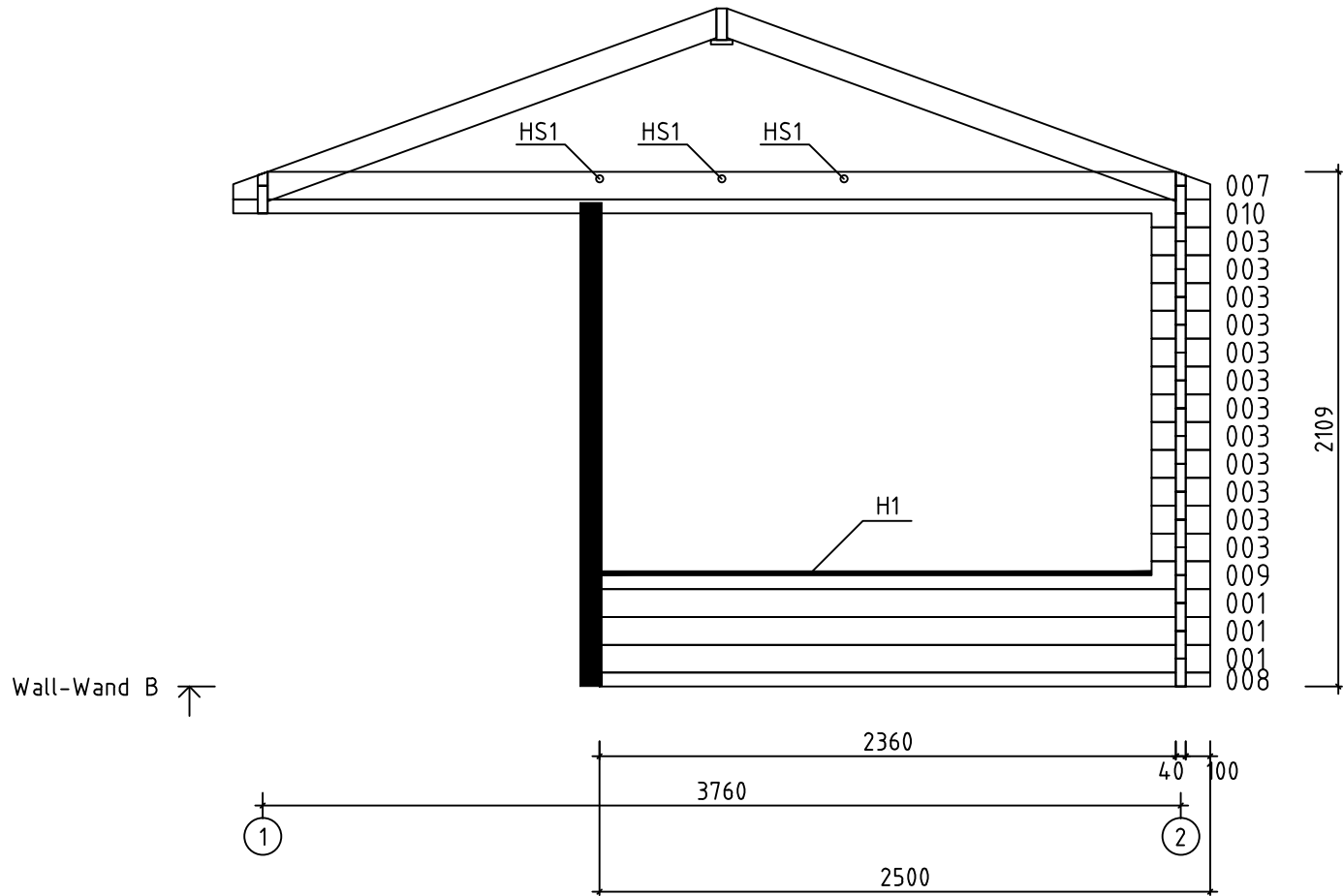

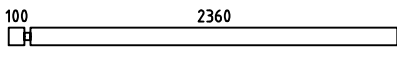
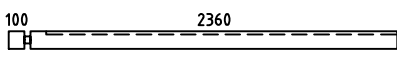

Model	Maik40	Drawing	WALL-WAND 2	Page	5	
 www.gartenhaus-gmbh.de www.gartenhaus.at www.gartenhaus.ch +49 (0) 40 537 9978-50	Drawn by	R.Tamm	Material	4x11.4	Scale	1:30
	Date	20.04.2017	File	Maik40.dwg		

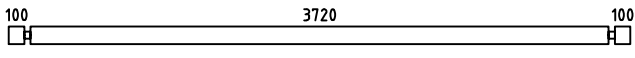
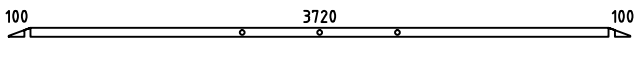
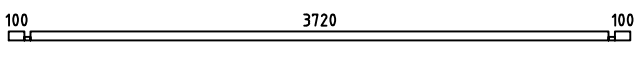
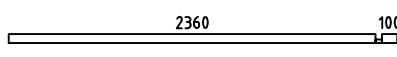
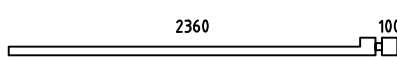
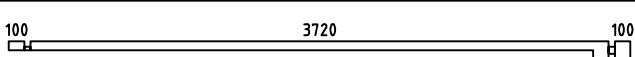
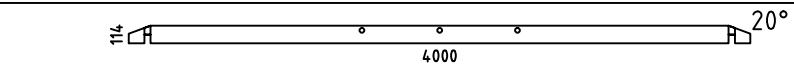
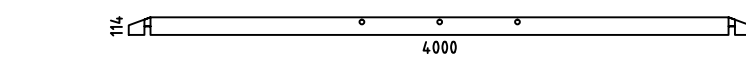
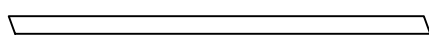
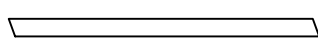
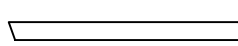
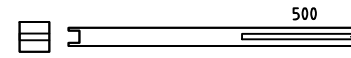
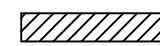
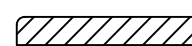
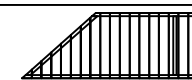

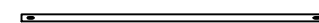

Model	Maik40	Drawing	WALL-WAND A	Page	2	
 www.gartenhaus-gmbh.de www.gartenhaus.at www.gartenhaus.ch +49 (0) 40 537 9978-50	Drawn by	R.Tamm	Material	4x11.4	Scale	1:30
	Date	20.04.2017	File	Maik40.dwg		

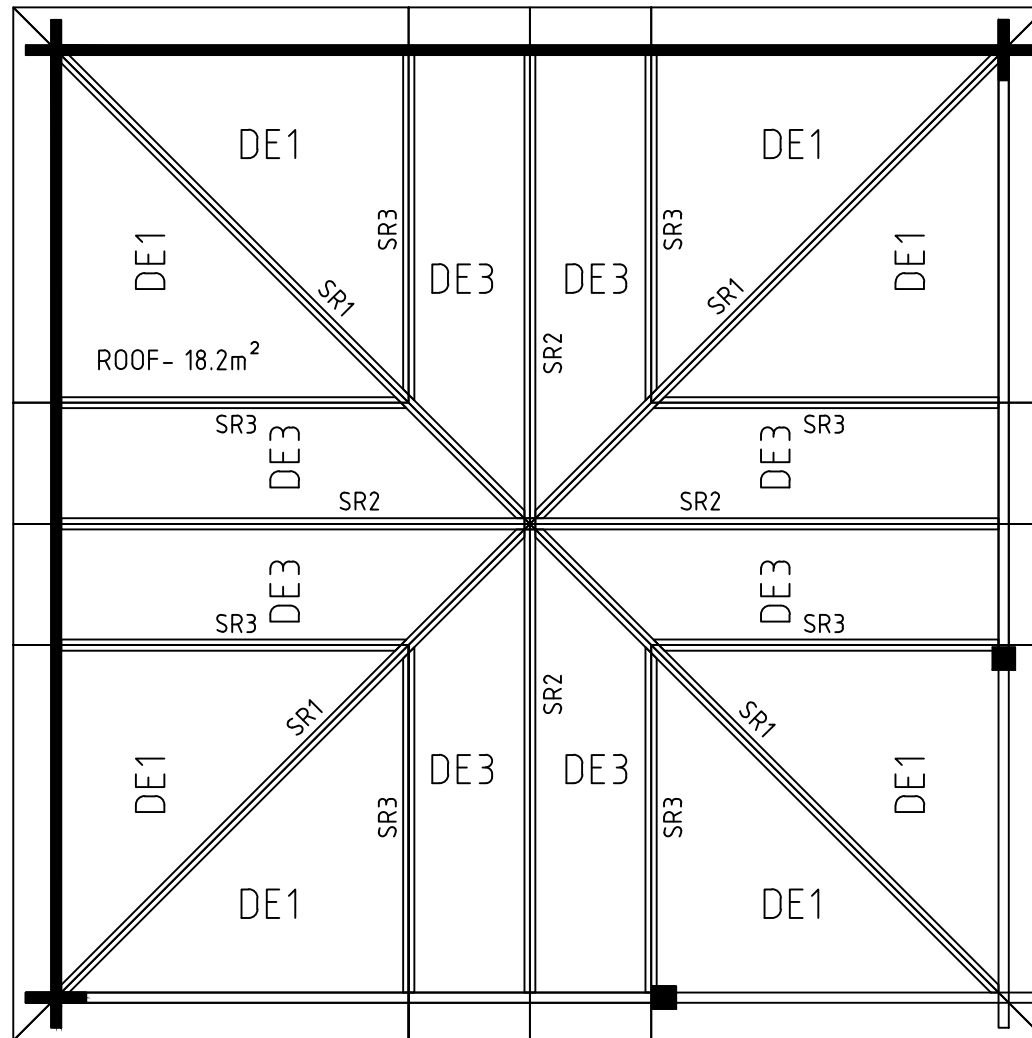

Model	Maik40	Drawing	WALL-WAND B	Page	3	
 www.gartenhaus-gmbh.de www.gartenhaus.at www.gartenhaus.ch +49 (0) 40 537 9978-50	Drawn by	R.Tamm	Material	4x11.4	Scale	1:30
	Date	20.04.2017	File	Maik40.dwg		

Pos	Specification-Spezifikation-Specificatie Maik40	St.	Profile (mm)	Length (mm)
001		6	40x114	2500
002		1	40x114	2500
003		25	40x114	240
004		36	40x114	4000
005		2	40x57	4000
006		1	40x57	4000
008		1	40x57	2500
009		1	40x114	2500
010		1	40x114	4000
WA-1		1		
WB-1		1		
SR1	RAFTER-DACHSPARREN-DAKSPAR 	4	44x114	2712
SR2	RAFTER-DACHSPARREN-DAKSPAR 	4	44x114	1998
SR3	RAFTER-DACHSPARREN-DAKSPAR 	4+4	44x114	1502
	-POST 90x90 	2		1983
	Eave Board-Traubret-Dakranden board 	4	18x88	4250
H1	Handrail-Handlauf 	2	18x90	2245
DE3	Roof Panel 3-Dach Elemente 3-Dakpanelen 3 	4+4	2215x485	
DE1	Roof Panel-Dach Elemente-Dakpanelen 	4+4	1685x1590	
	Storm Brace-Sturmleiste 	3	18x40	2000
	Adjustable foot-Stellfuß+Schrauben 4x50 4stück für Post 	2		
N1	Ridge piece-Firstelement-Nokstuk 	1		
	Screw-Schraube-Schroef 4x55 	160		
	Wood Bolt set for Storm Brace-Holzschraubensatz für Sturmleisten 6x45 	6		
HS1	Wood Bolt set-Holzschraubensatz-Hout Bout 8x80 	12		
Kood	GartenHaus GmbH	Materjal	File Maik40.dwg	Leht 1/1



Model	Maik40	Drawing	ROOF	Page
 www.gartenhaus-gmbh.de www.gartenhaus.at www.gartenhaus.ch +49 (0) 40 537 9978-50	Drawn by	R.Tamm	Material	40x114
	Date	20.04.2017	File	Maik40.dwg
			Scale	1:30

The guide is illustrative. This guide is not project specification.
Der Leitfaden ist illustrativ. Dieser Leitfaden ist keine Projektspezifikation.
De gids is illustratief. Deze gids is geen projectspecificatie.

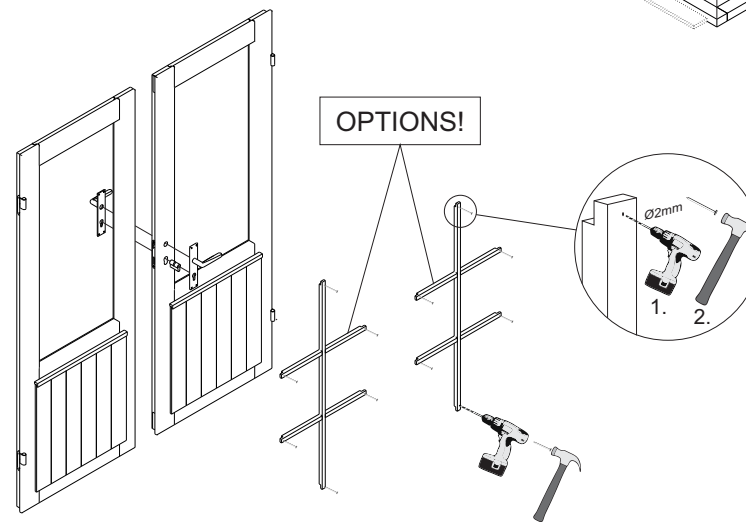
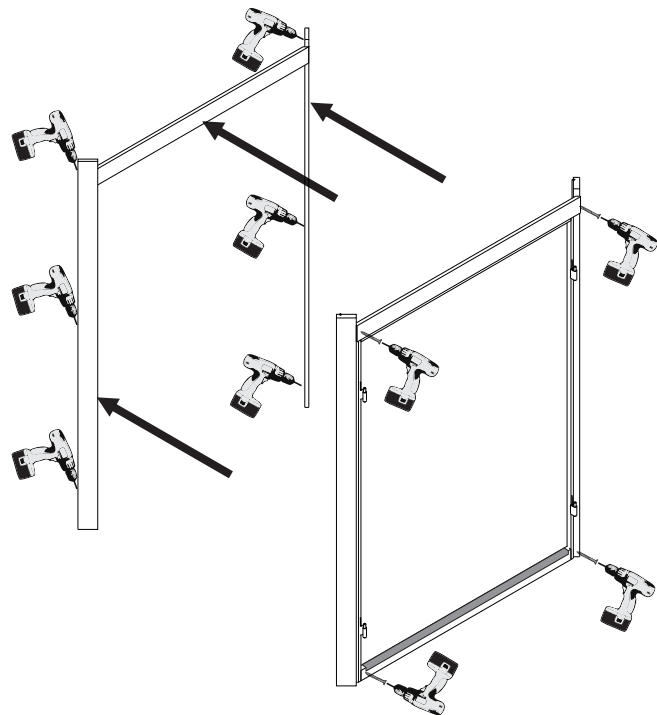
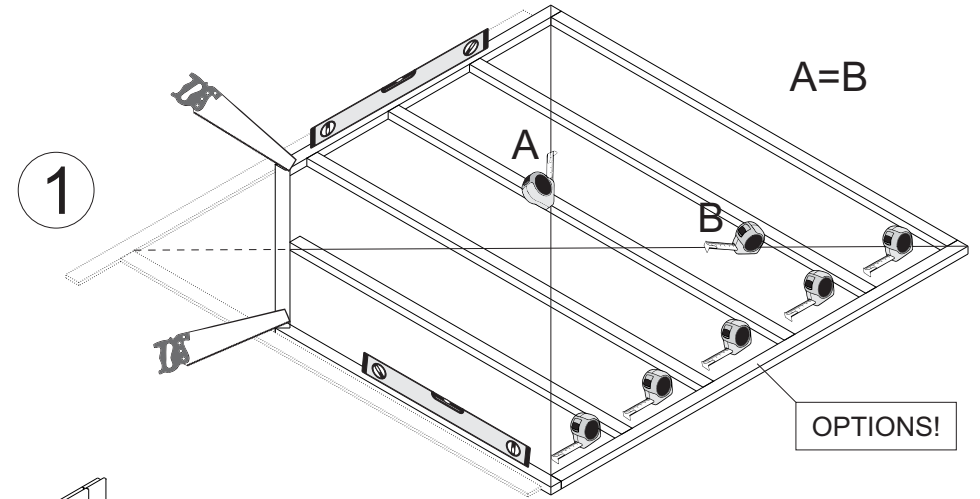
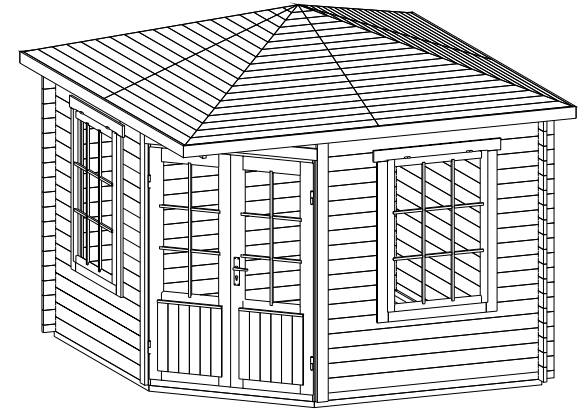
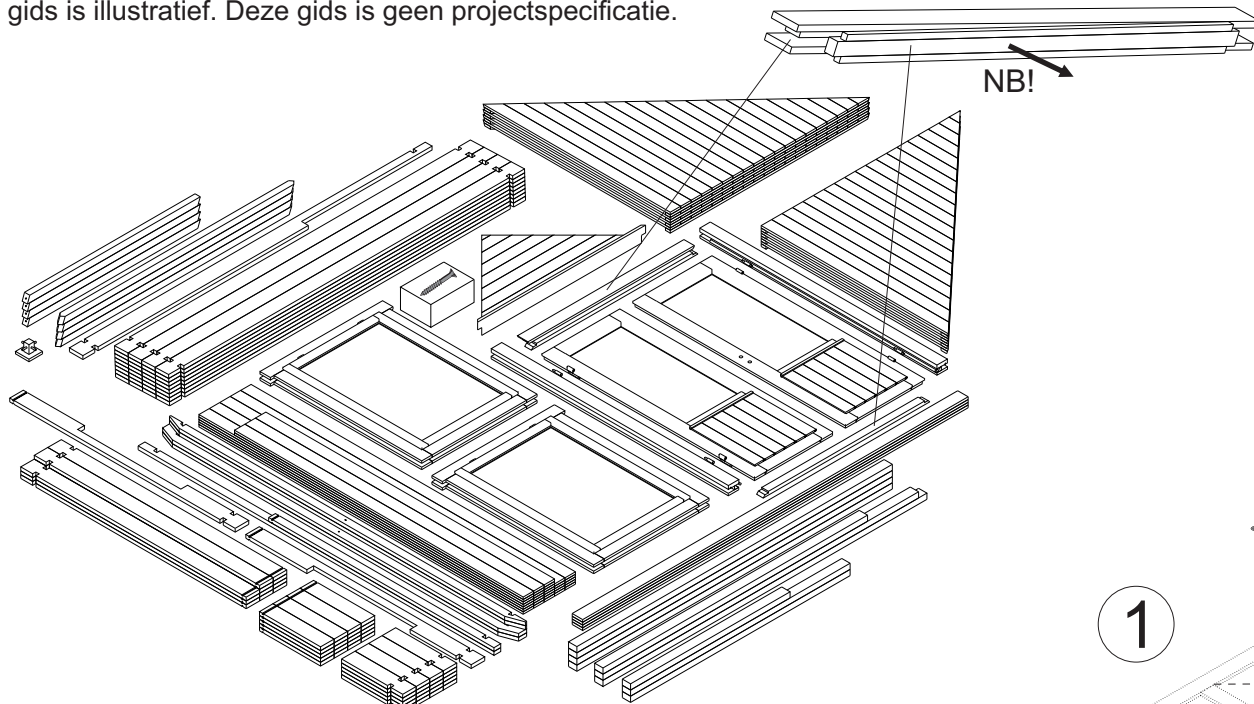

2

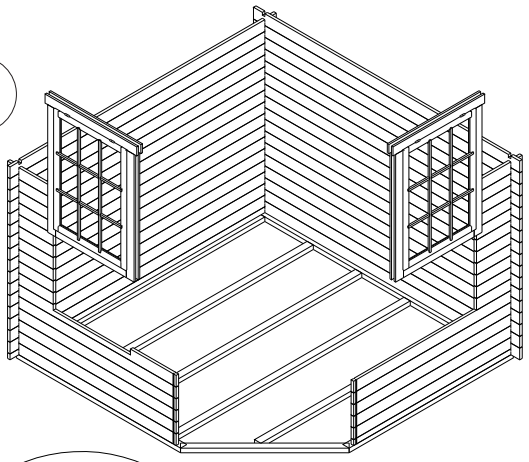

3

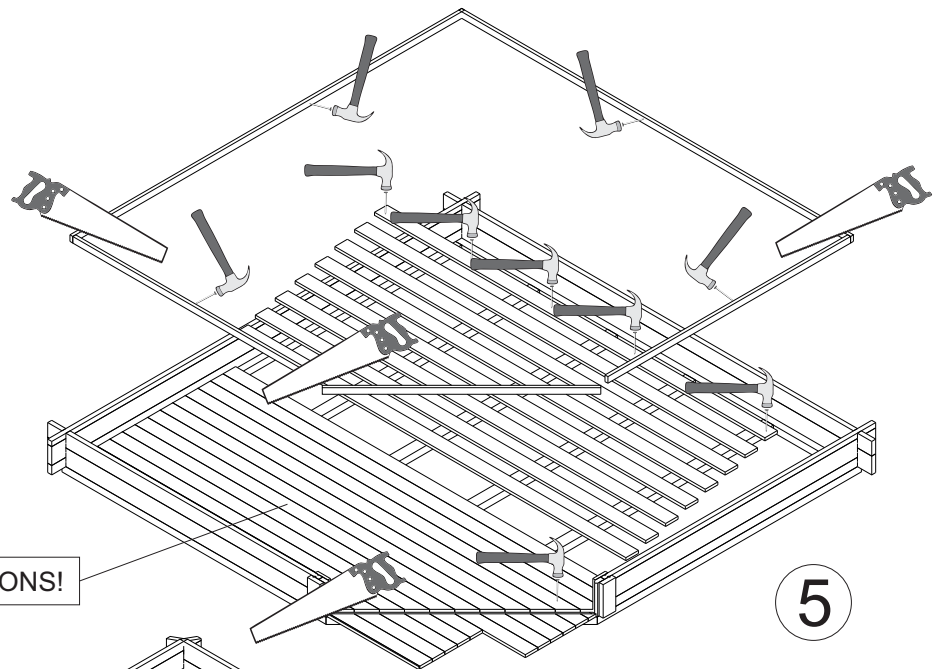
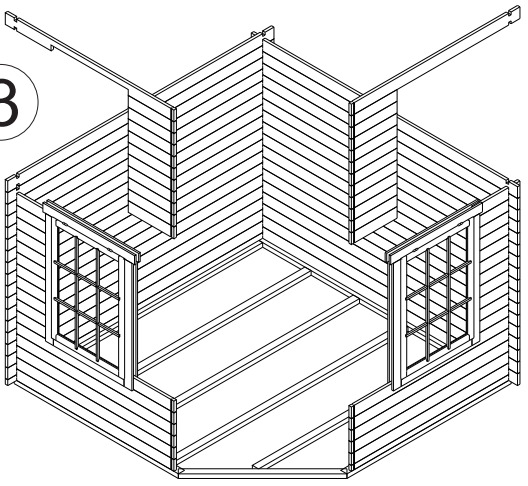

5

OPTIONS!

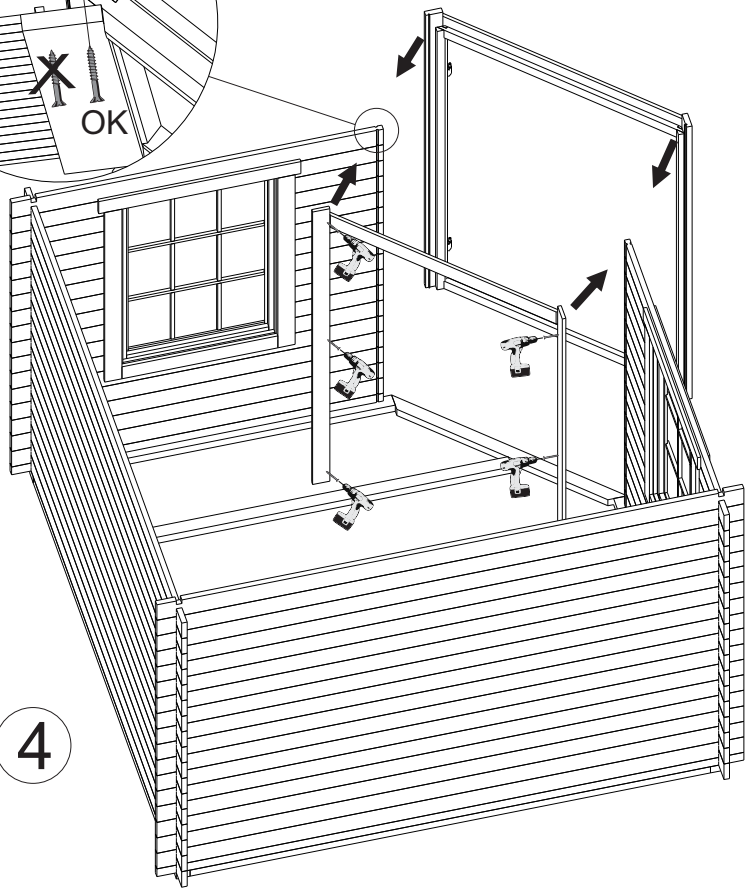
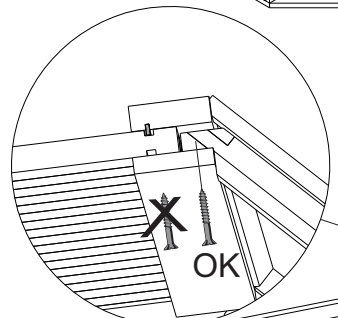

4

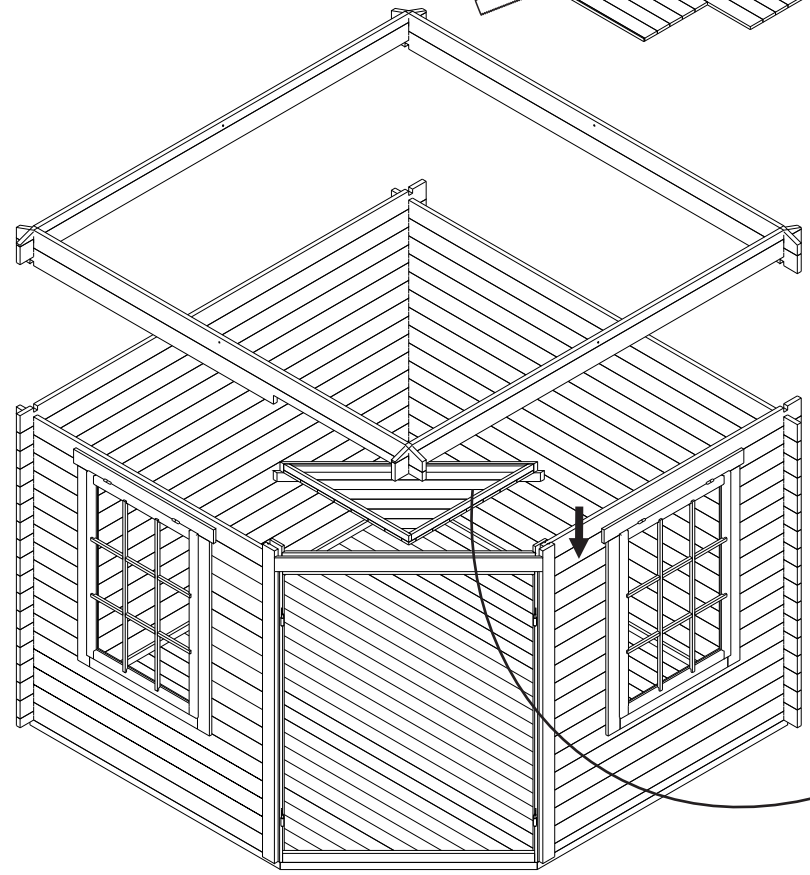

6

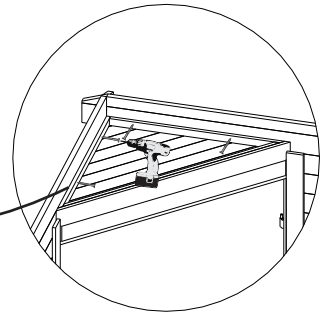

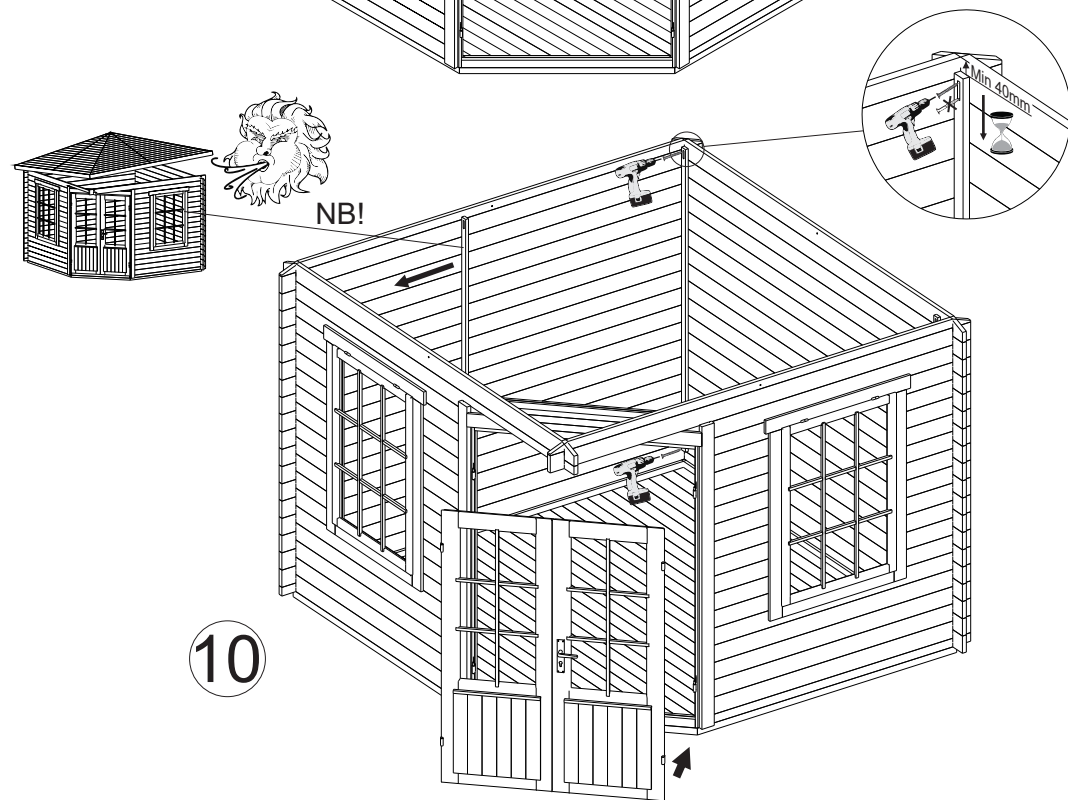
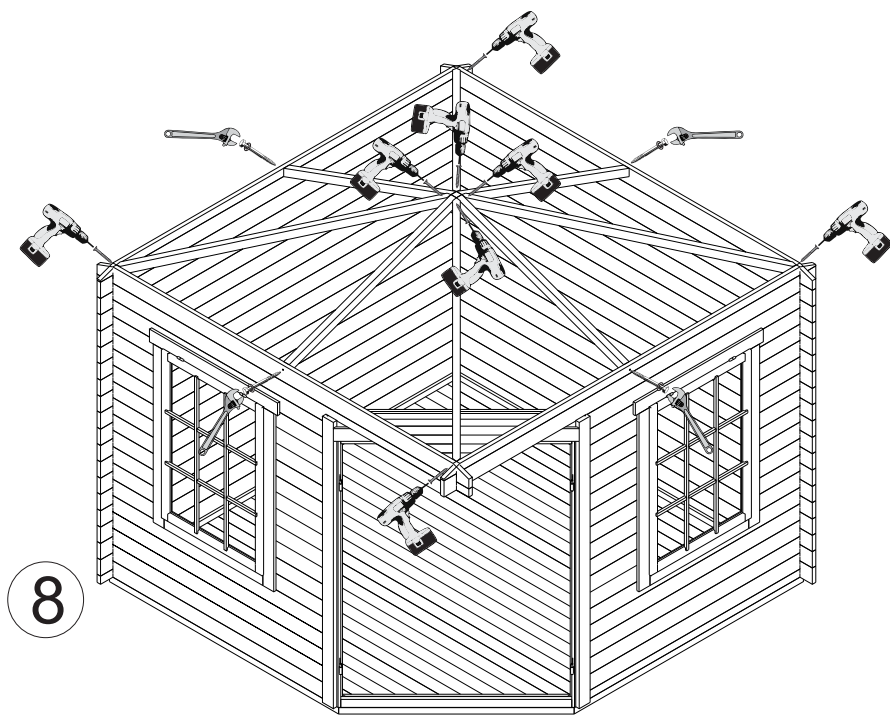
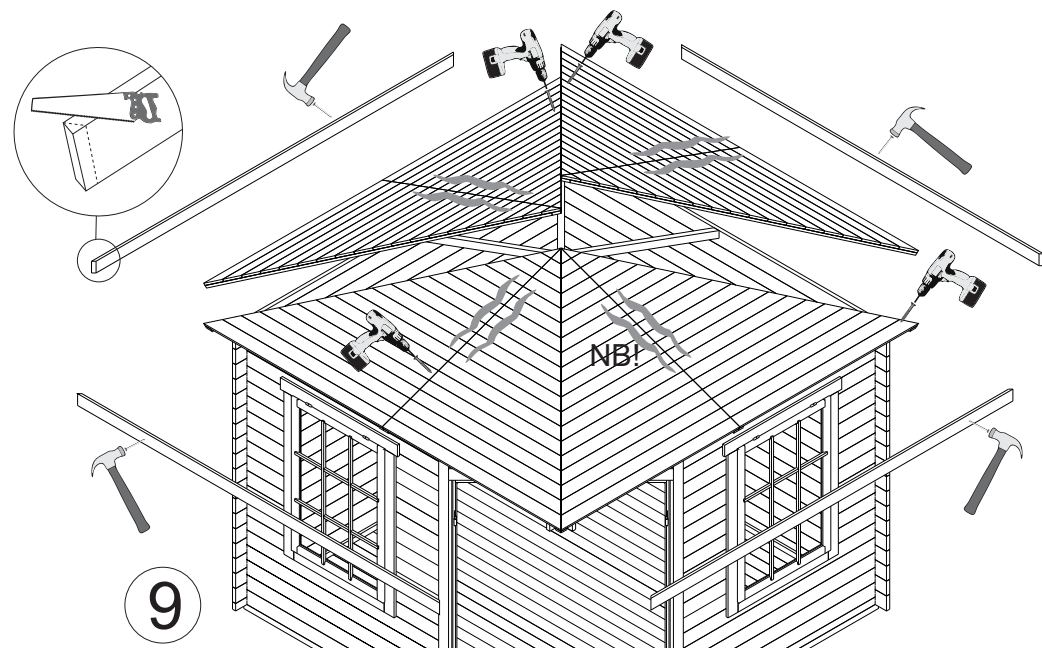
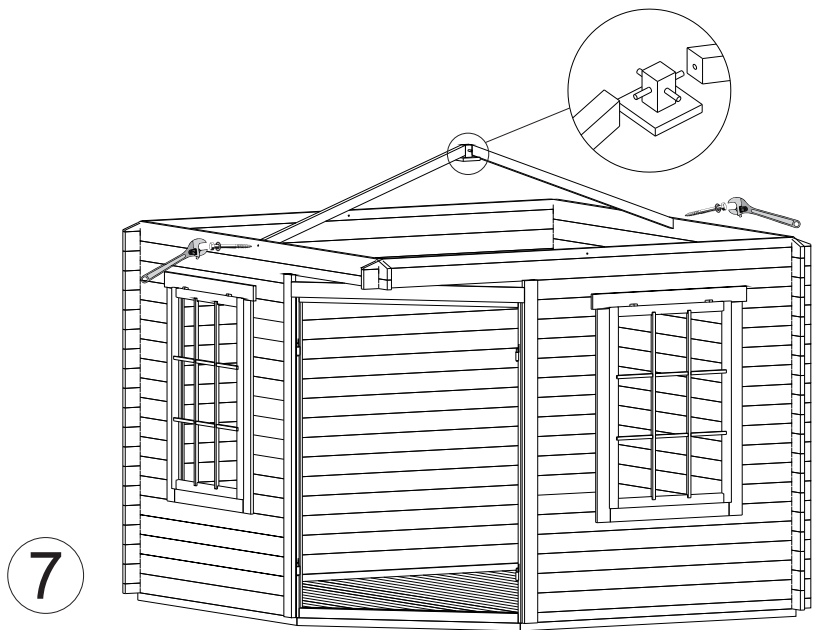

POST

