

#99423 #99424 #99425
Rollcontainer HWC-L49

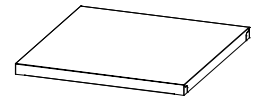
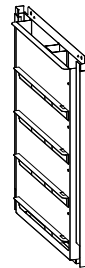
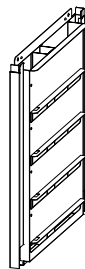
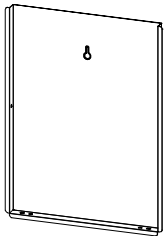
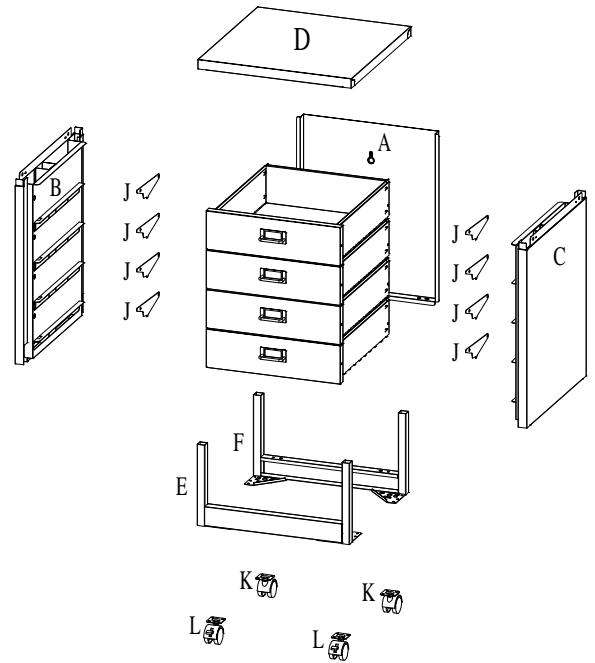
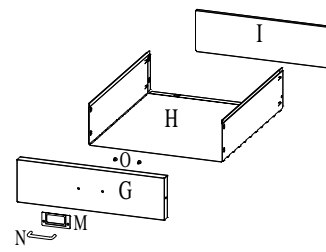
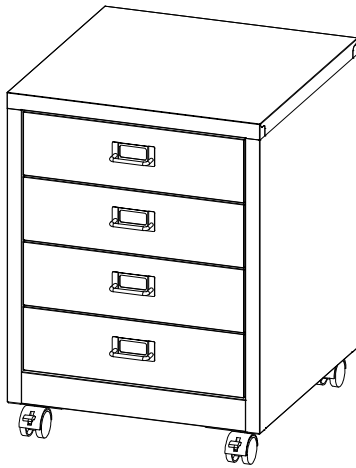

-A
-1 pcs
-43.45×35.3cm
-Name: back panel, linke Rückwand

-B
-1 pcs
-48.5×41cm
-Name: left side, linke Seitenwand

-C
-1 pcs
-48.5×41cm
-Name: right side, linke Seitenwand

-D
-1 pcs
-41.05×40.07cm
-Name: top, Schrankdeckel

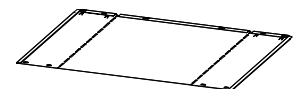
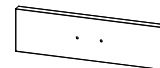
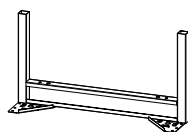









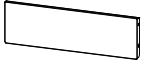

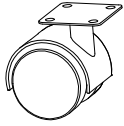
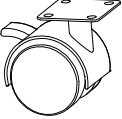
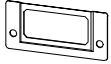
-E
-1 pcs
-21×39.8cm
-Name: supporting, Stützrahmen

-F
-1 pcs
-21×39.8cm
-Name: supporting, Stützrahmen

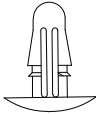
-G
-4 pcs
-10×35cm
-Name: drawer panel, vordere Schubladenblenden

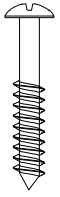
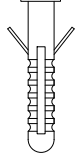
-H
-4 pcs
-38×51cm
-Name: drawer plate, Schubladenboden

 <p>-I -4 pcs -9.7×31.3cm -Name: back panel of drawer, hintere Schubladenblenden</p>	 <p>-J -8 pcs -4.08×15.5cm -Name: metal sheet to prevent derailment</p>	 <p>-K -2 pcs -5.5×4.0cm -Name: wheels, Rollen Stück</p>
 <p>-L -2 pcs -5.5×4.0cm -Name: the brake wheels, Bremsrollen Stück</p>	 <p>-M -4 pcs -3.08×6.65cm -Name: card holder</p>	 <p>-N -4 pcs -2.05×6.15cm -Name: handle</p>
 <p>-O -8 pcs -0.4×0.5cm -Name: screws, Schrauben</p>	 <p>-P -10 pcs -0.4×1.2cm -Name: screws, Schrauben Stück</p>	 <p>-Q -10 pcs -∅1.3×1.2cm -Name: screws, Schrauben Stück</p>
 <p>-R -16 pcs -0.5×1.2cm -Name: screws, Schrauben Stück</p>	 <p>-S -1 pcs -0.5×4cm -Name: screws, Schrauben Stück</p>	 <p>-T -1 pcs -0.8×4cm -Name: screws, Schrauben Stück</p>
 <p>-U -16 pcs -cm -Name: screws, Schrauben Stück</p>	 <p>-V -8 pcs -cm -Name: screws, Schrauben Stück</p>	

Das Montageset ist am Inneren des Karton befestigt!

The assembly set is attached to the inside of the box!

Le kit de montage est fixé à l'intérieur du carton!

Il materiale per il montaggio è posizionato all'interno della scatola fissato con il nastro adesivo!

El material de montaje se coloca dentro de la caja fijado con cinta adhesiva!

Step 1

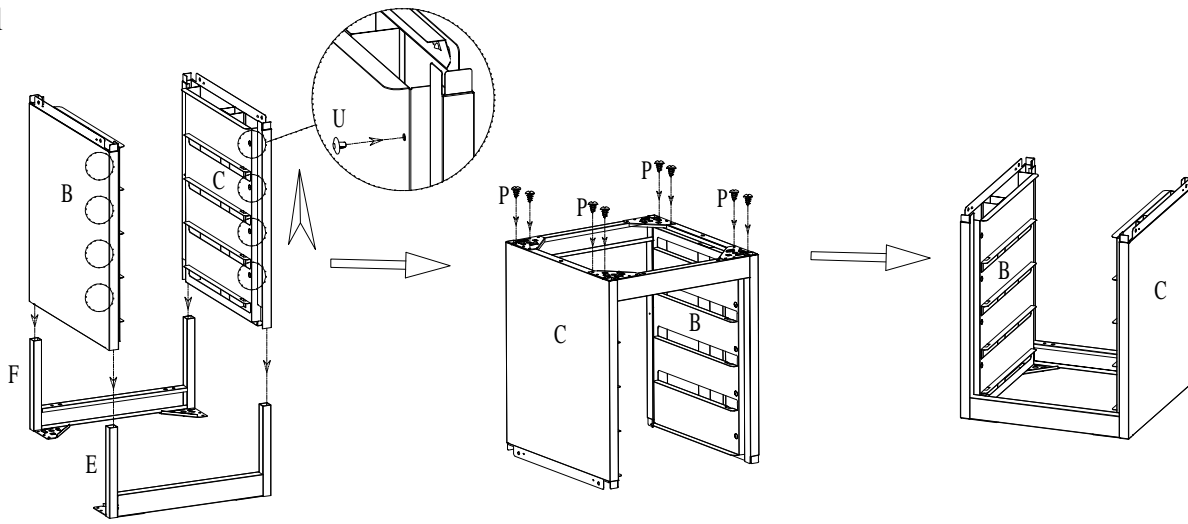

Need

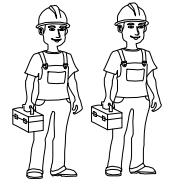

- Part B 1PCS
- Part C 1PCS
- Part E 1PCS
- Part F 1PCS
- Part P 8PCS
- Part U 8PCS

Step 2

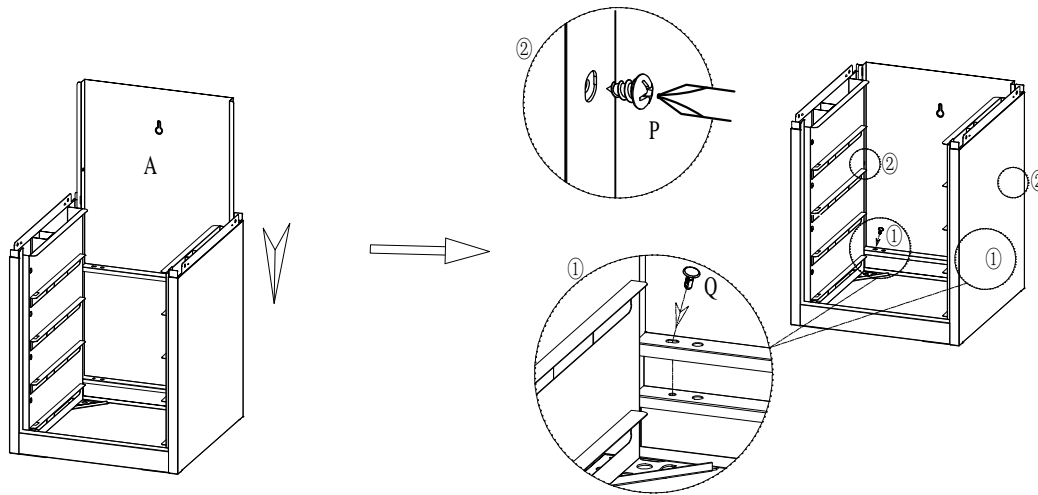

Need

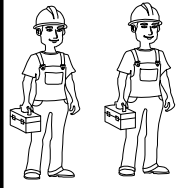

- Part A 1PCS
- Part Q 2PCS
- Part P 2PCS

Step 3

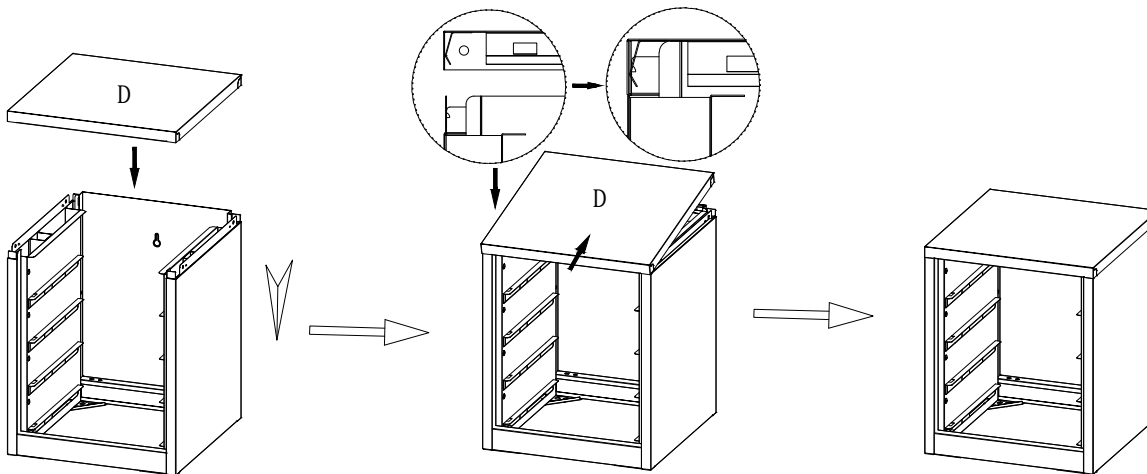

Need



- Part D 1PCS

Step 4

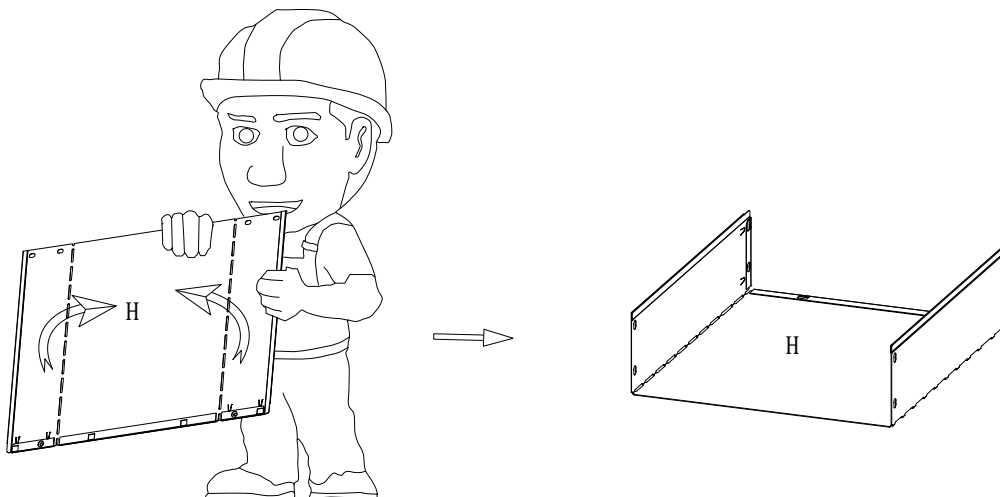

Need



- Part H 4PCS

Step 5

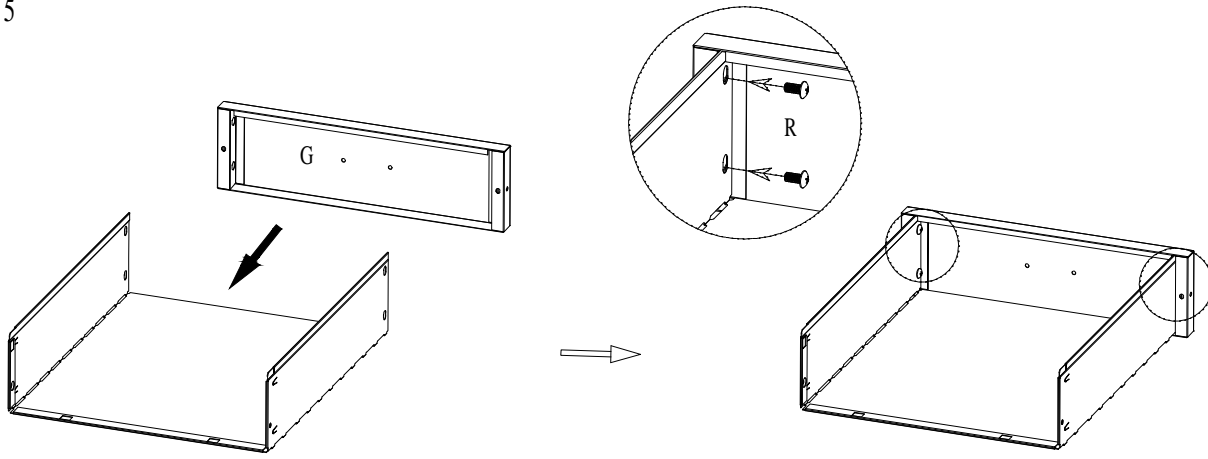

Need



Part G 4PCS
Part R 16PCS

Step 6

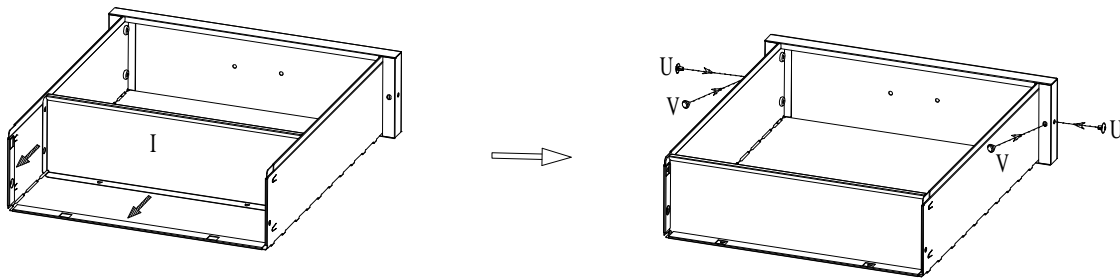

Need



Part I 4PCS
Part U 8PCS
Part V 8PCS

Step 7

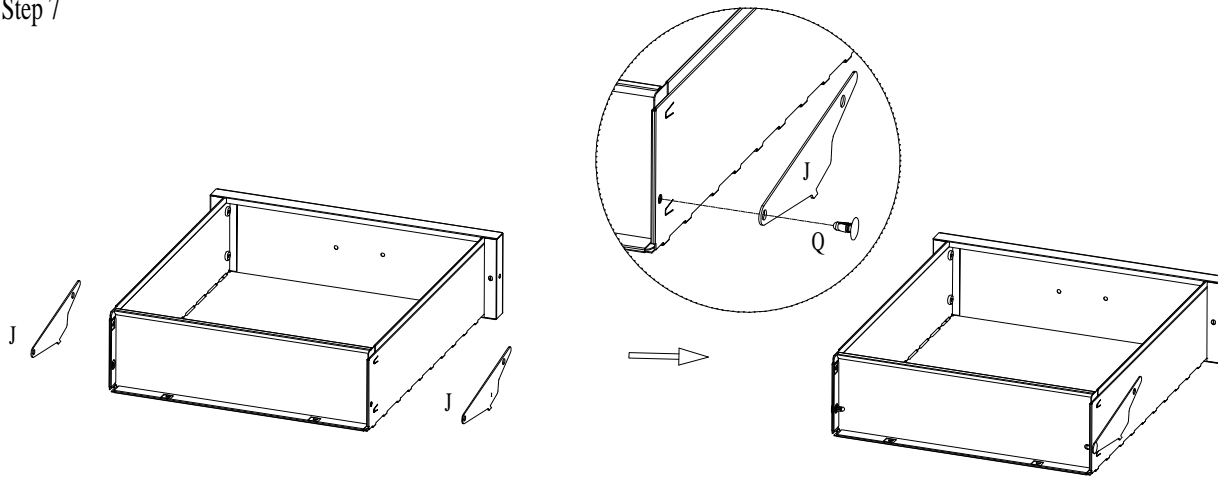

Need



Part J 8PCS
Part Q 8PCS

Step 8

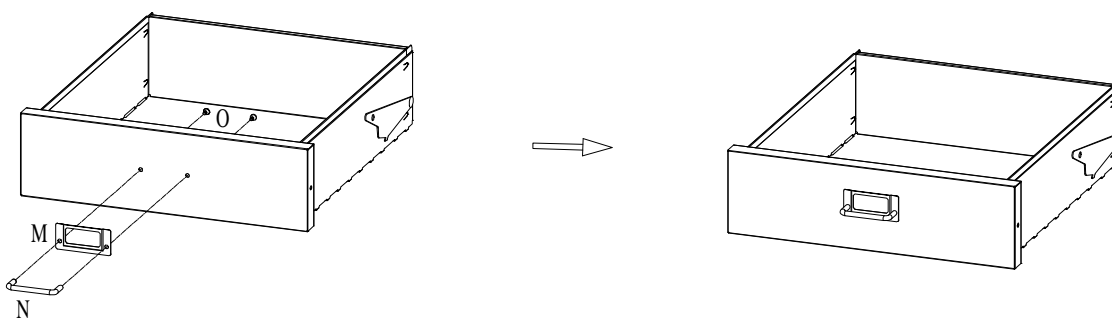

Need



Part M 4PCS
Part N 4PCS
Part O 8PCS

Step 9

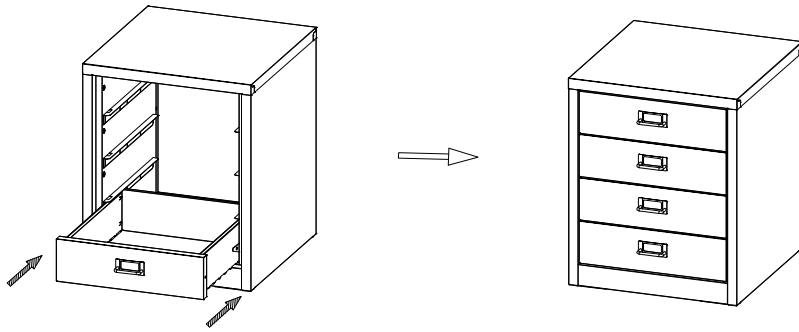

Need



Step 10

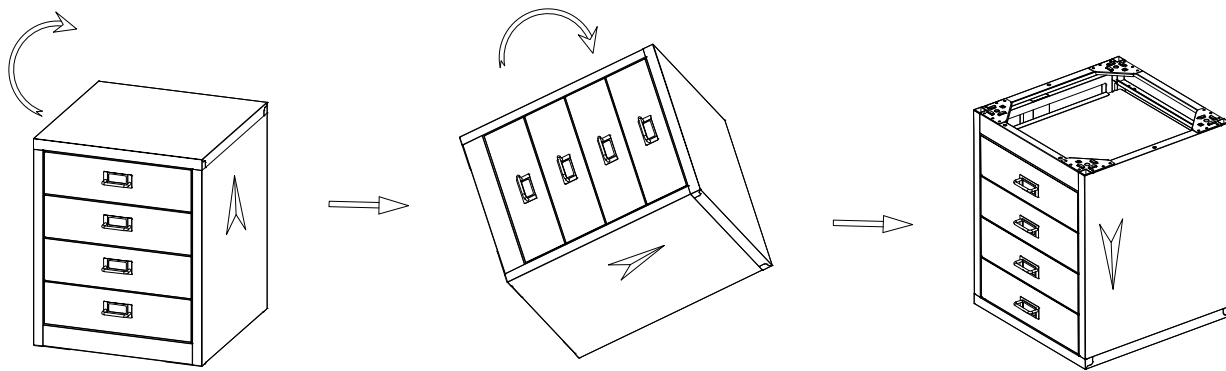

Need



Step 11

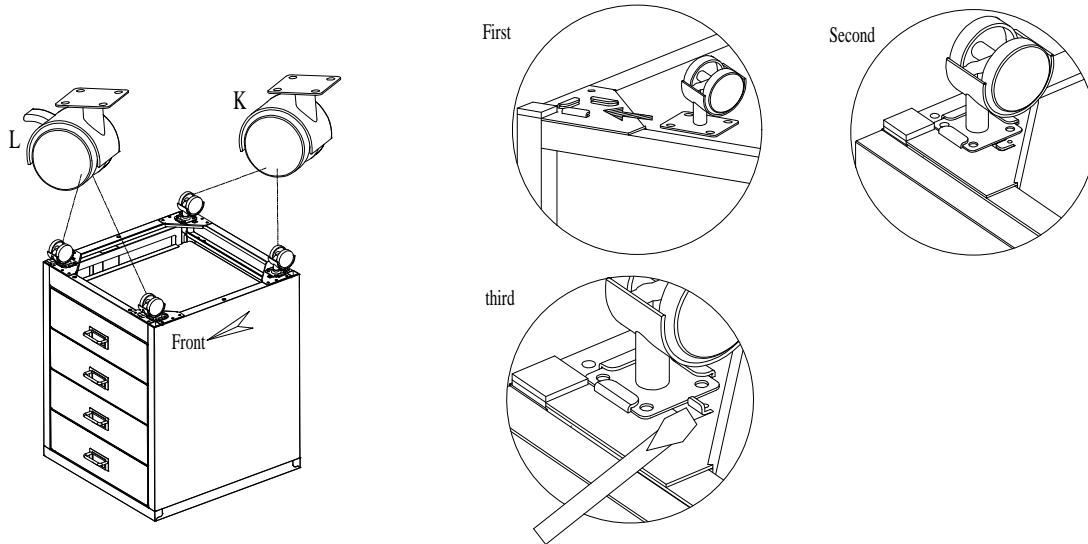

Need



Part K 2PCS
Part L 2PCS

Step 12

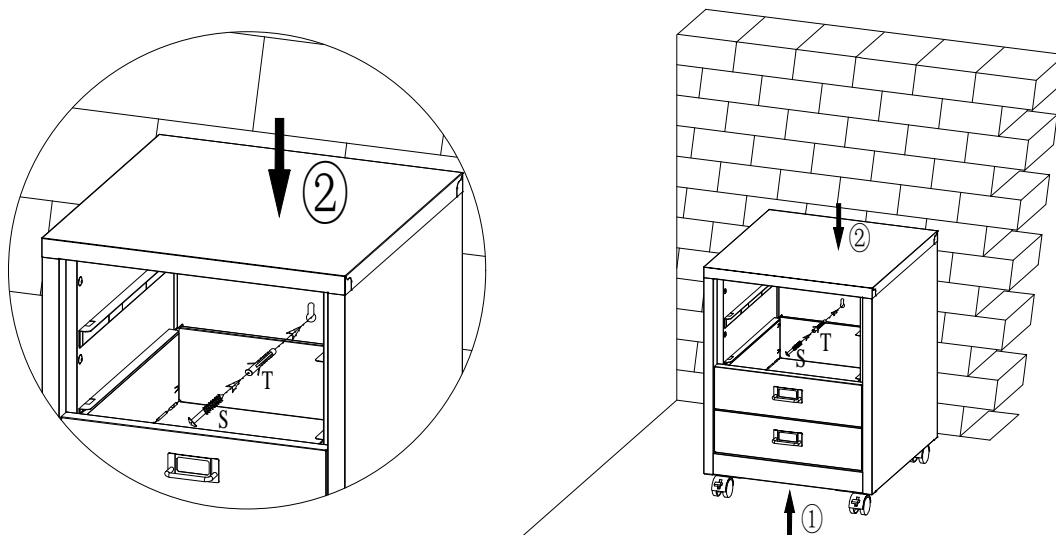

Need



Part S 1PCS
Part T 1PCS