

SILG

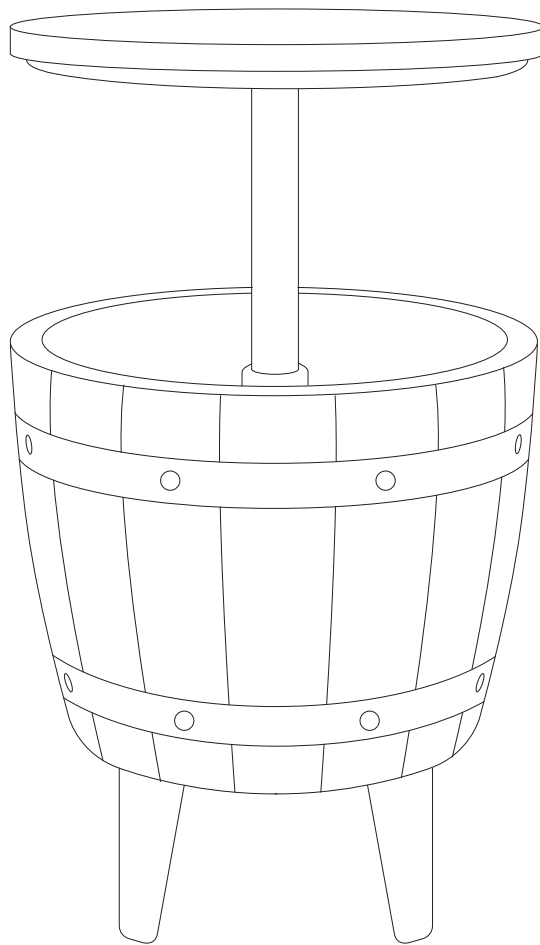

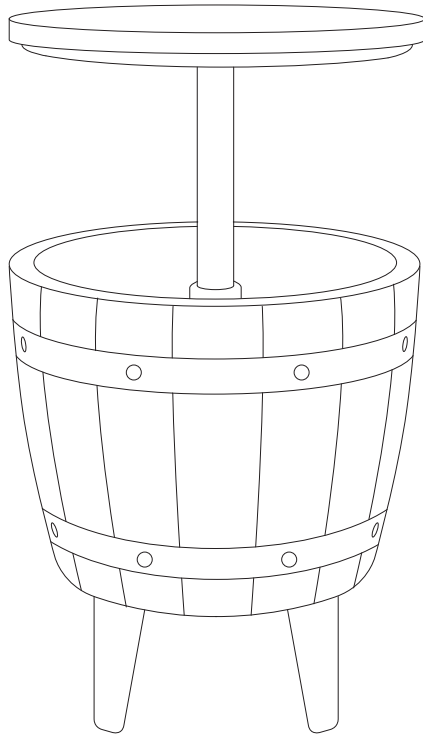

Assembly instructions for step 1/3:

- Tools:** A screwdriver is shown as the required tool. A power drill is shown with a diagonal line through it, indicating it is not to be used.
- Warning:** A triangular warning symbol with an exclamation mark is present.
- Time:** A clock icon indicates an estimated assembly time of 5 minutes.
- Personnel:** An icon of a person indicates that 1 person is required for assembly.

A

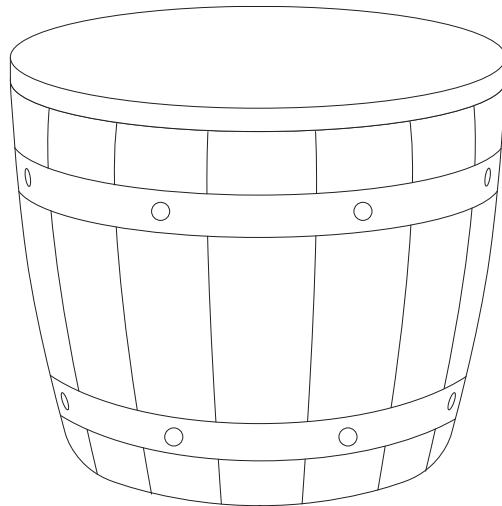

B x 4

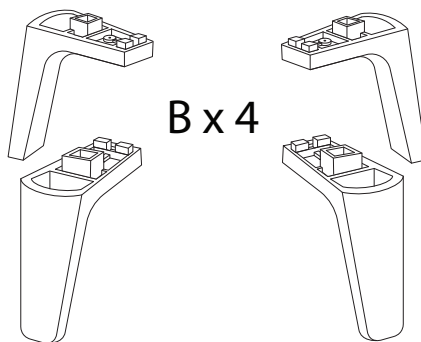

A

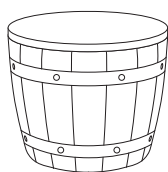

x 1

B

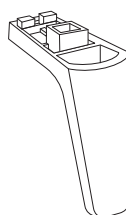

x 4

C

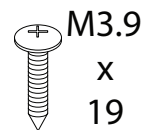

x 4

1

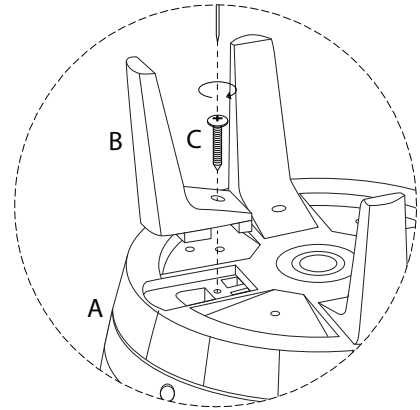
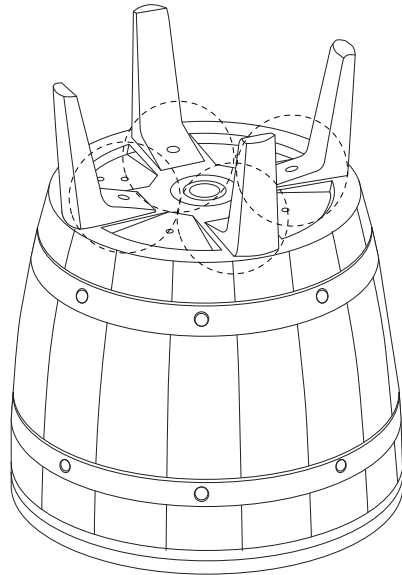
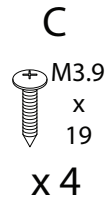

2

