

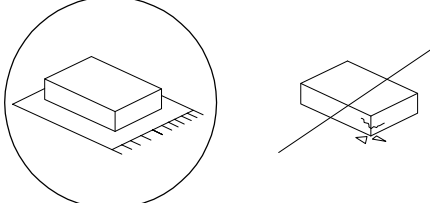





		<p>10'</p>
		
		<p>2</p>

A	B	C	D	E
			 M6 x 20	
x 1	x 4	x 4	x 16	x 1

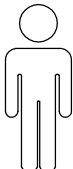
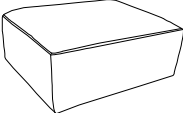
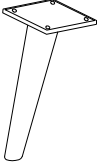
A

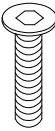

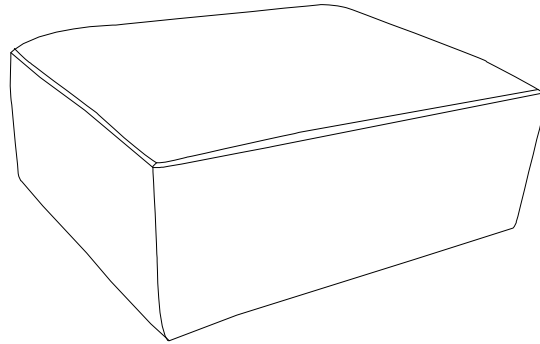
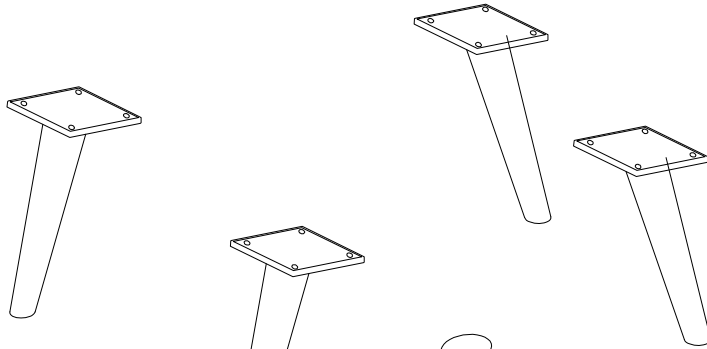

B x 4

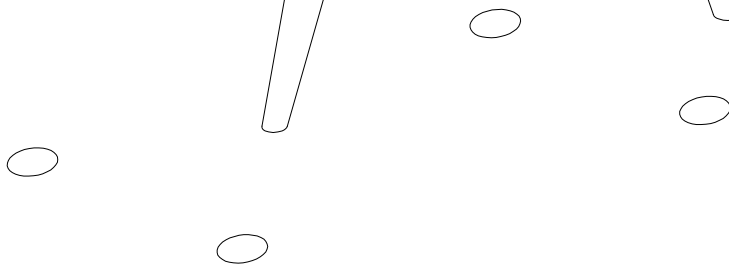

C x 4

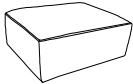
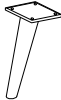

1

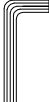
<p>A</p>  <p>x 1</p>	<p>B</p>  <p>x 4</p>	<p>C</p>  <p>x 4</p>	<p>D</p>  <p>M6 x 20 x 16</p>	<p>E</p>  <p>x 1</p>
---	---	---	--	---

