

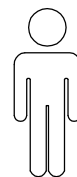

30'

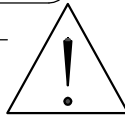

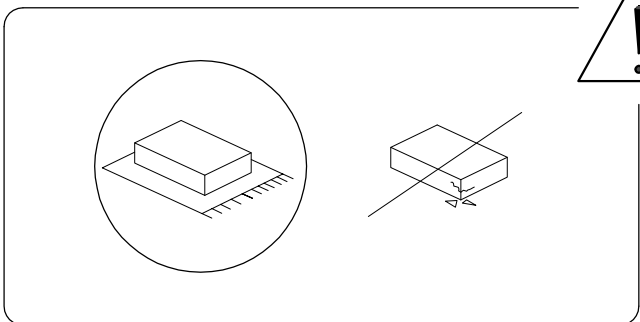

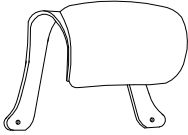
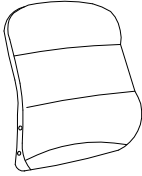

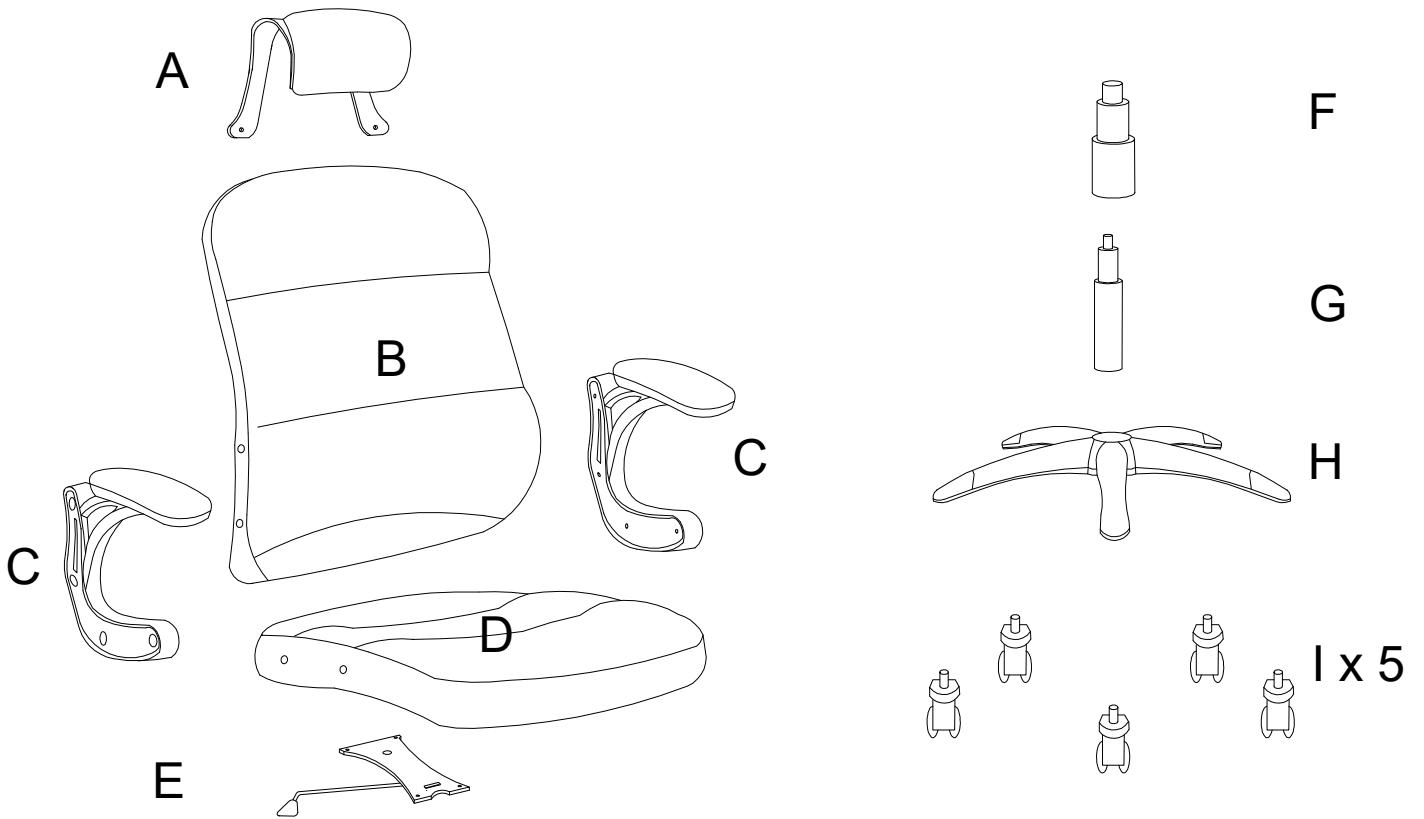

1

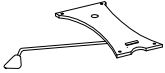
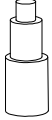
1/5

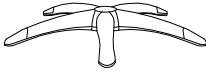
A	B	C	D
			
x 1	x 1	x 2	x 1

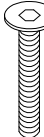
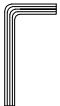

E	F	G	H	I
				
x 1	x 1	x 1	x 1	x 5
J	K	L	M	N
	 M6 x 30	 M6 x 20	 M6 x 35	
x 8	x 8	x 4	x 2	x 1

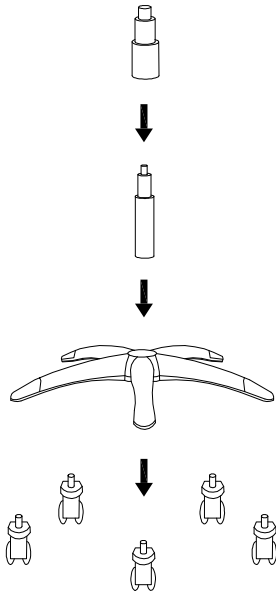
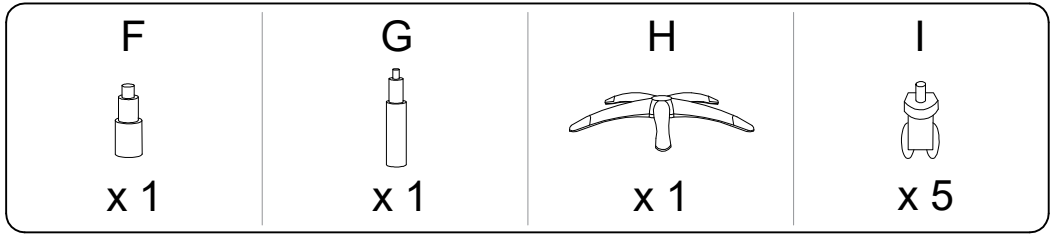

1

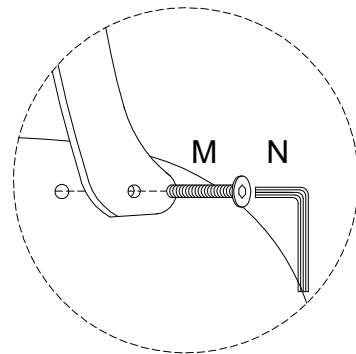
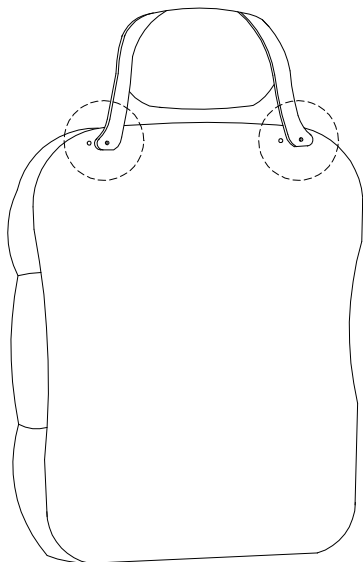
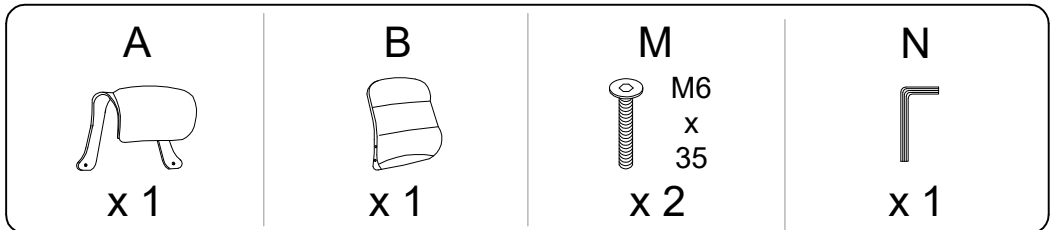

2



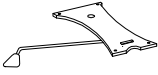

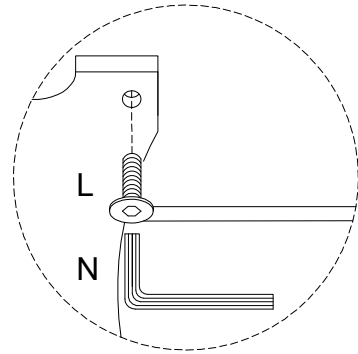
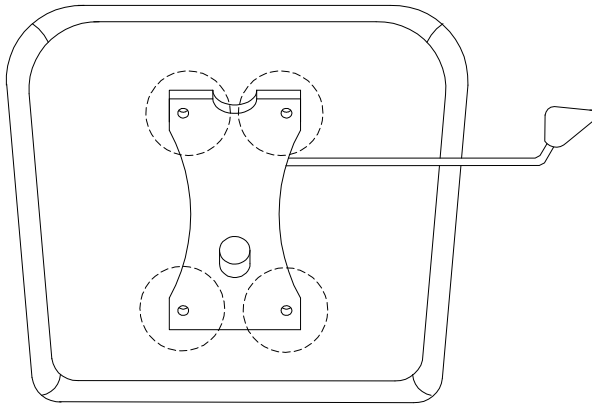

3

<p>D</p>  <p>x 1</p>	<p>E</p>  <p>x 1</p>	<p>L</p> <p>M6 x 20</p>  <p>x 4</p>	<p>N</p>  <p>x 1</p>
---	---	---	---

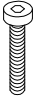

4

<p>C</p>  <p>x 2</p>	<p>J</p>  <p>x 8</p>	<p>K</p> <p>M6 x 30</p>  <p>x 8</p>	<p>N</p>  <p>x 1</p>
---	---	---	---

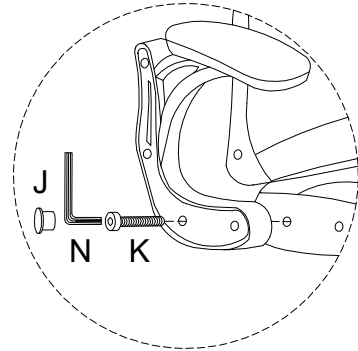
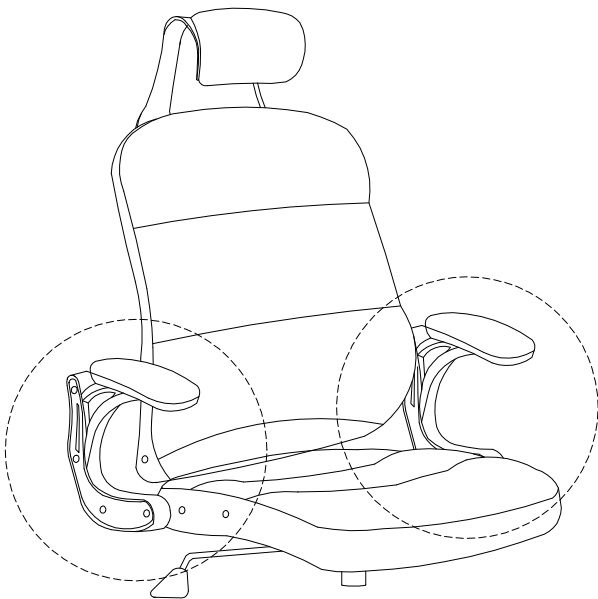

5

