

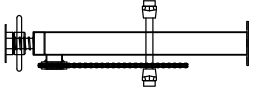

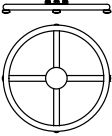





Ax1 	Bx1 	Cx1 	Dx2  L*1. R*1	Ex1  12mm	Fx1  14mm	 5mm
---	--	--	--	--	--	--

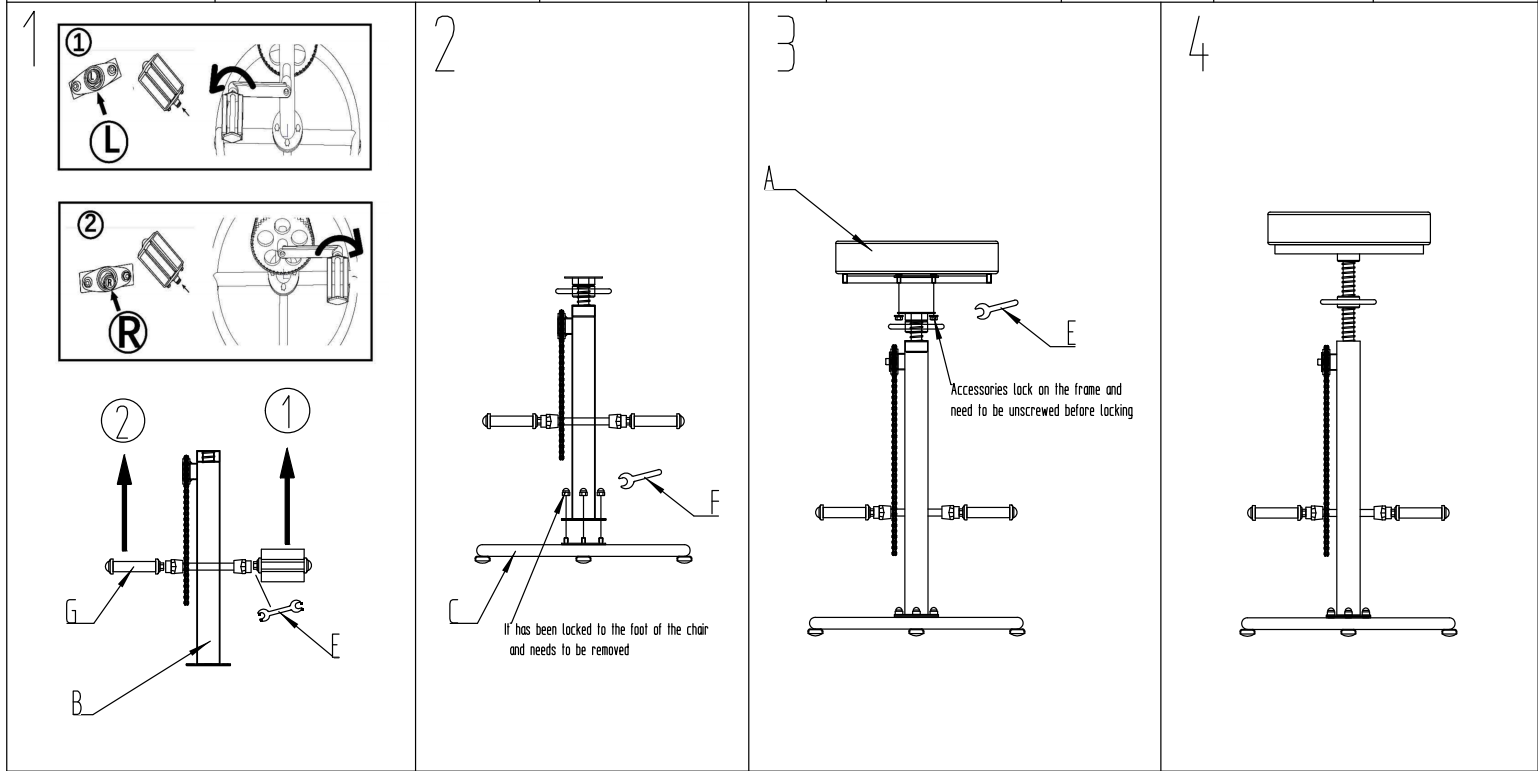
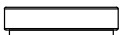
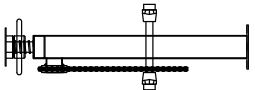
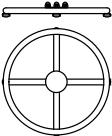

Ax1 	Bx1 	Cx1 	Dx2  L*1. R*1	Ex1  12mm	Fx1  14mm	 5mm
---	--	--	--	--	--	--

