

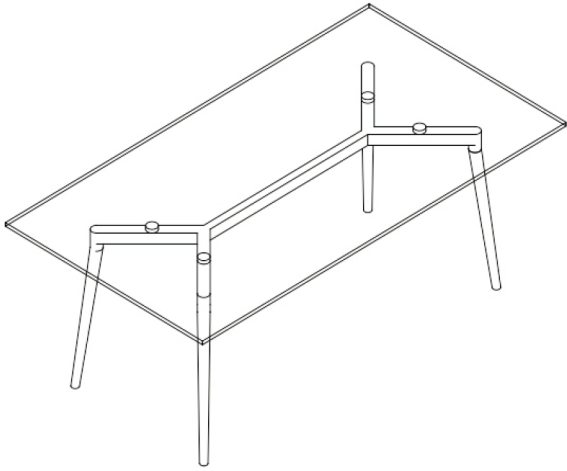







ASSEMBLY INSTRUCTION



A*4  M8*35	B*4  M10*50	C*4  M8*20	D*4  ø53.5
E*1  5#	F*4  M10	G*1  M10	

