

h heute wohnen

# Assembly Instructions

Modell-Nr:9802672

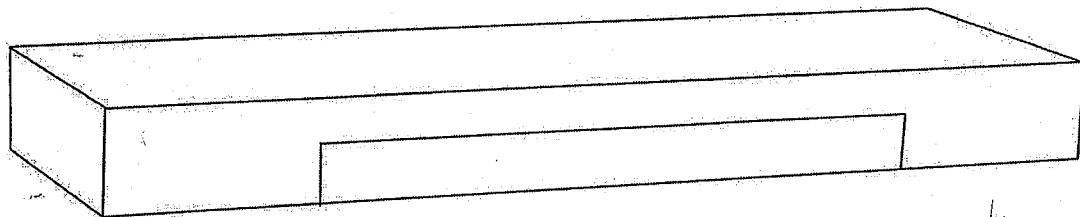

Das Montageset ist am Inneren des Karton befestigt!

The assembly set is attached to the inside of the carton!

Le kit de montage est fixé à l'intérieur du carton!

Il materiale per il montaggio è posizionato all'interno della scatola fissato con il nastro adesivo!

El material de montaje se coloca dentro de la caja fijado con cinta adhesiva!

Mendler Vertriebs-GmbH  
Industriestr.60  
D - 73642 Welzheim

## Components/Teileliste

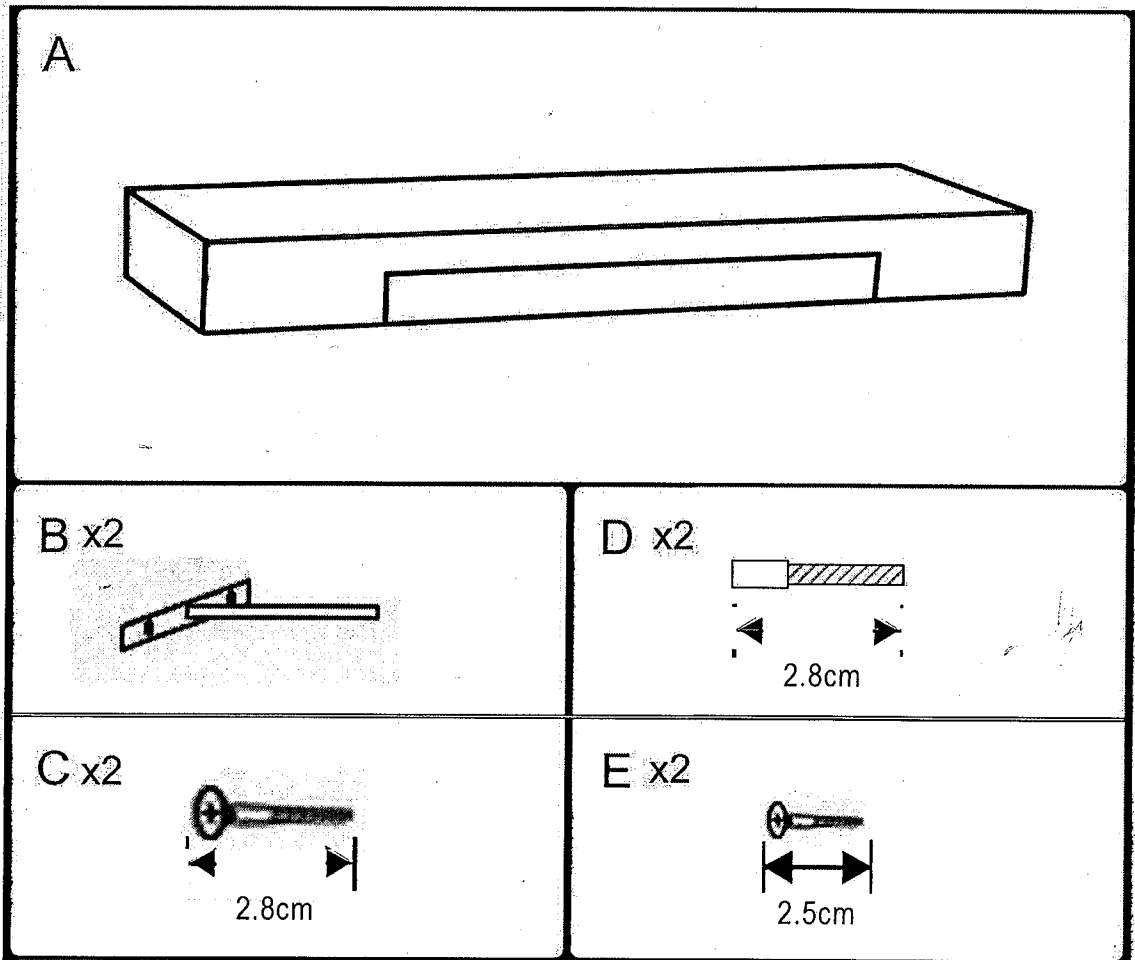

# heute wohnen

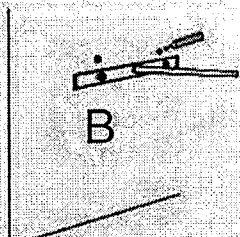

1. Position the places of holes with the 1pc of metal T-shaped display hook and mark them well.

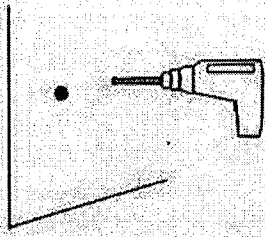

2. Drill the holes according to the size of the Expansive screws.

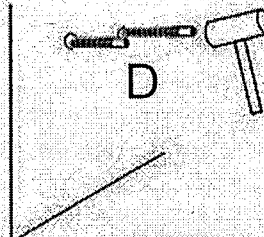

3. Fully install the expansion screws in the holes

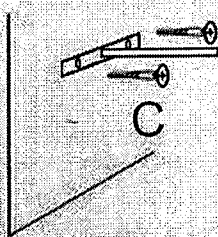

4. Use screw to fix the metal T-shaped display hook on the wall.

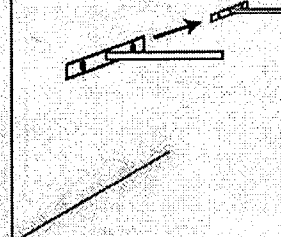

5. Using measure tape to measure the distance between two holes of the item and fix it accordingly.

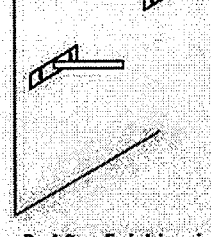

6. After finishing installmant of T-shaped display hook,Put the wall shelf on it then installation is finished.

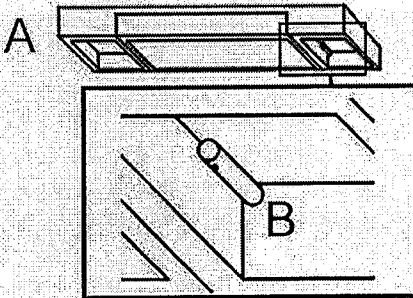
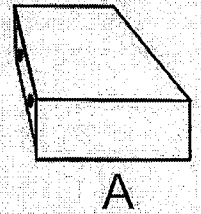

7. There is a hole on the hook.

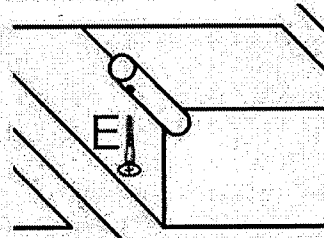

8. Will use srew to fix the hook into the top board of the wall shelf.

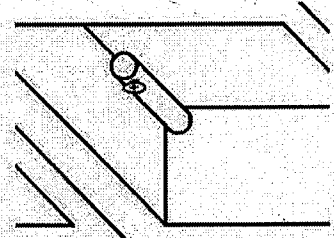

9. Finish