

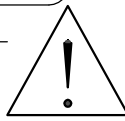

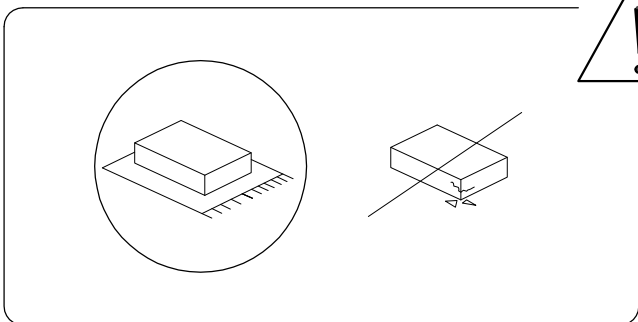

90'

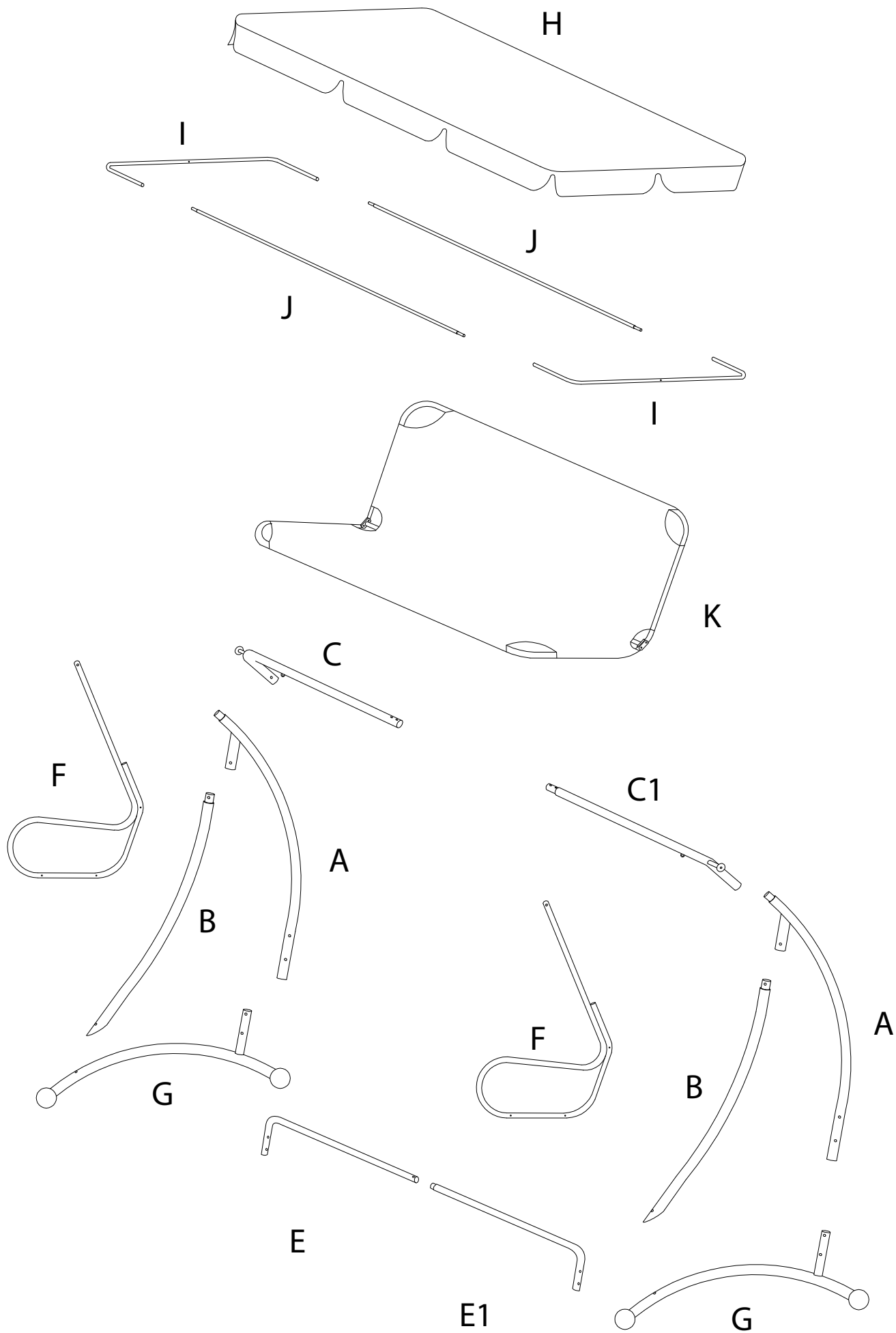

2

1/10

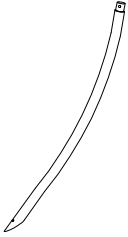
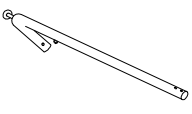
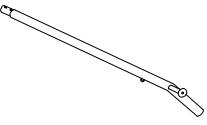
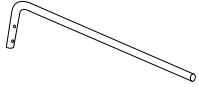
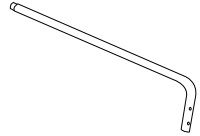
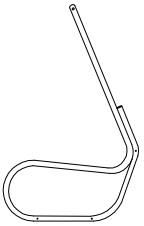
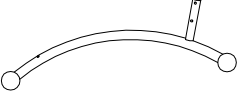
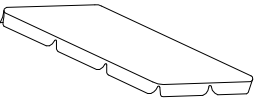

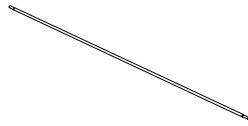
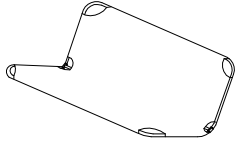
|   |  |  |   |
|---|--|--|---|
| <p>A</p>  <p>x 2</p>   | <p>B</p>  <p>x 2</p>    | <p>C</p>  <p>x 1</p>   | <p>C1</p>  <p>x 1</p>  |
| <p>E</p>  <p>x 1</p> | <p>E1</p>  <p>x 1</p> | <p>F</p>  <p>x 2</p> | <p>G</p>  <p>x 2</p> |
| <p>H</p>  <p>x 1</p> | <p>I</p>  <p>x 2</p>  | <p>J</p>  <p>x 2</p> | <p>K</p>  <p>x 1</p> |

L

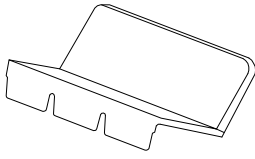

x 1

M

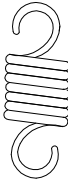

x 2

N

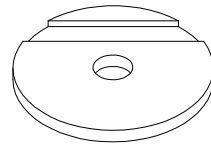

x 4

O

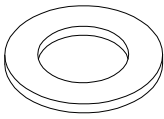

x 7

P

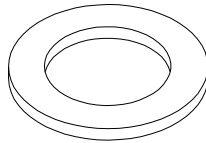

x 12

Q

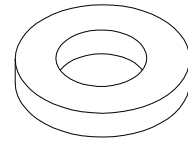

x 6

R

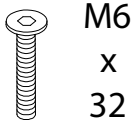

M6  
x  
32

x 1

S

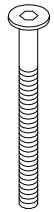

M6  
x  
70

x 6

T

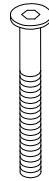

M8  
x  
58

x 8

U

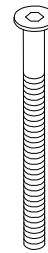

M8  
x  
80

x 6

V

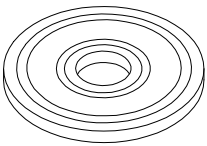

x 2

W

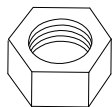

x 7

X

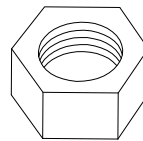

x 12

Y

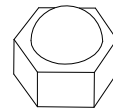

x 11

Z

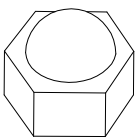

x 12

Γ



x 1

Δ

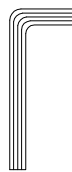



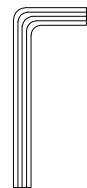

x 1

Θ





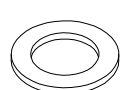
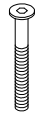
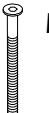
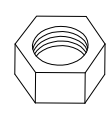
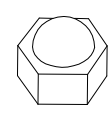

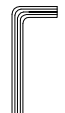

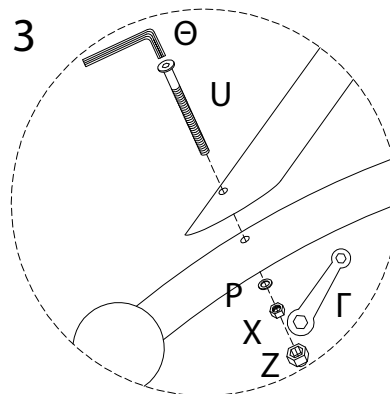
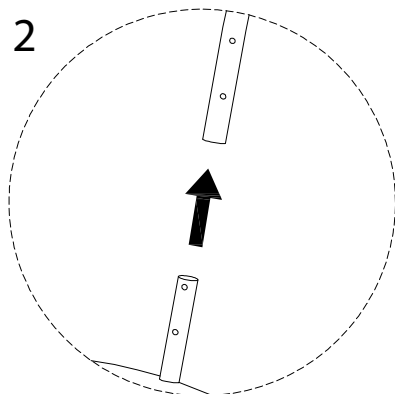
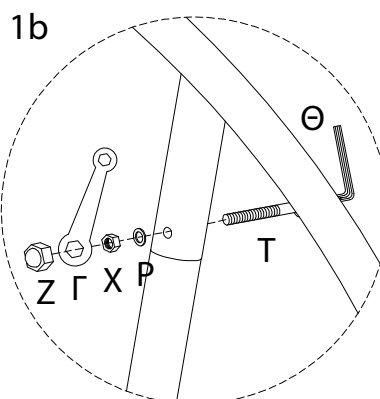
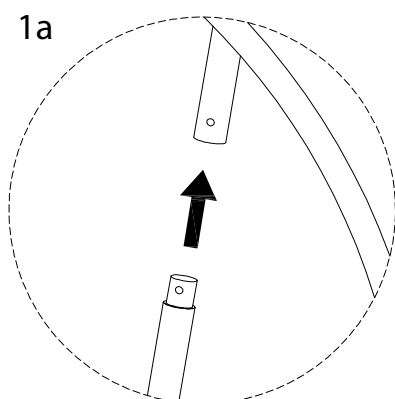
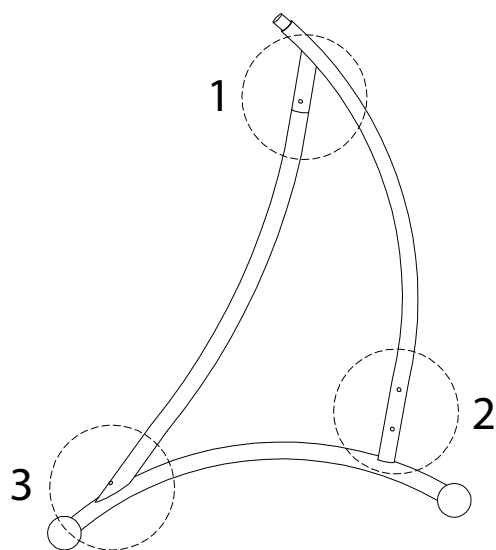
x 1

1 x 2

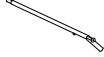
|   |  |  |  |   |
|---|--|--|--|---|
| <b>A</b><br><br>x 1                  | <b>B</b><br><br>x 1 | <b>G</b><br><br>x 1 | <b>P</b><br><br>x 2 | <b>T</b><br><br>M8<br>x<br>58<br>x 1 |
| <b>U</b><br><br>M8<br>x<br>80<br>x 1 | <b>X</b><br><br>x 2 | <b>Z</b><br><br>x 2 | <b>Γ</b><br><br>x 1 | <b>Θ</b><br><br>x 1                  |

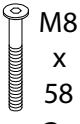



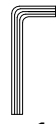

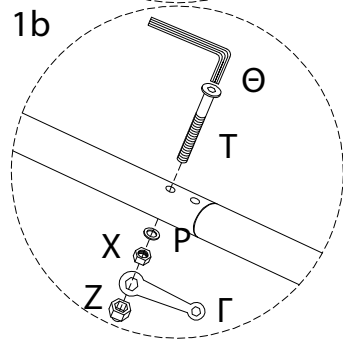
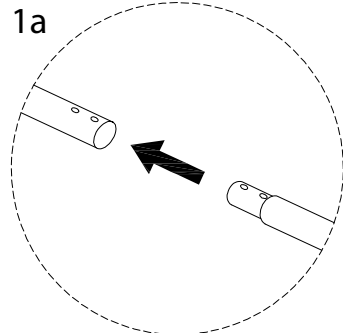
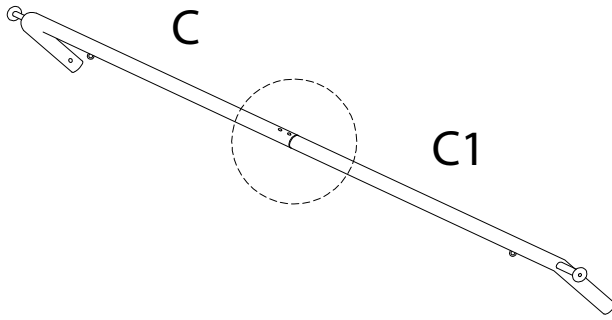
2

|   |   |   |   |   |   |   |   |
|---|---|---|---|---|---|---|---|
| C   | C1  | P   | T<br>M8<br>x<br>58  | X   | Z   | Г   | Θ   |
|  |  |  |  |  |  |  |  |
| x1  | x1  | x2  | x2  | x2  | x2  | x1  | x1  |





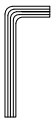

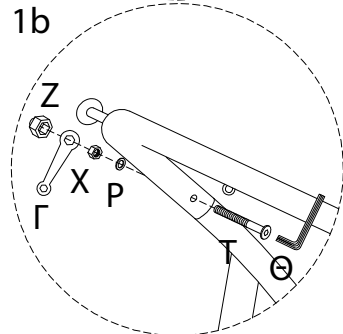
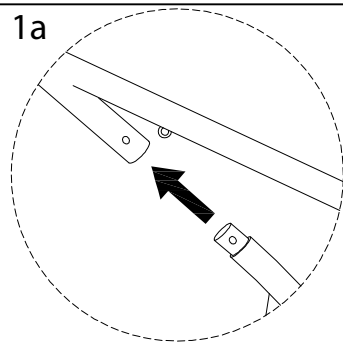
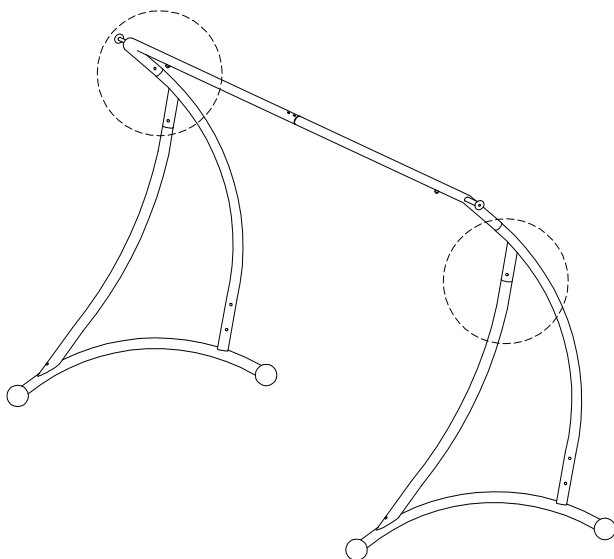

3

|   |   |   |  |   |   |
|---|---|---|--|---|---|
| P   | T<br>M8<br>x<br>58  | X   | Z  | Г   | Θ   |
|  |  |  |  |  |  |
| x2  | x2  | x2  | x2   | x1  | x1  |

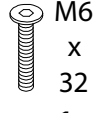

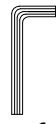

4

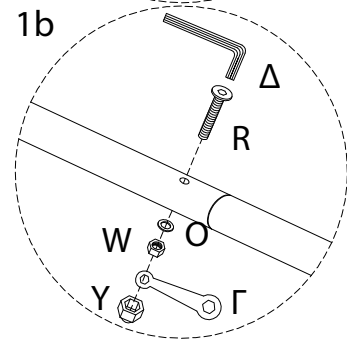
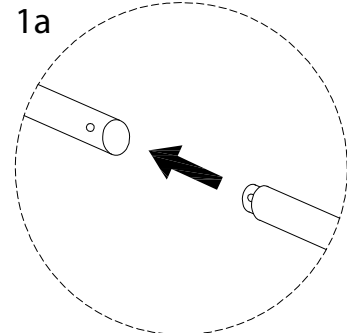
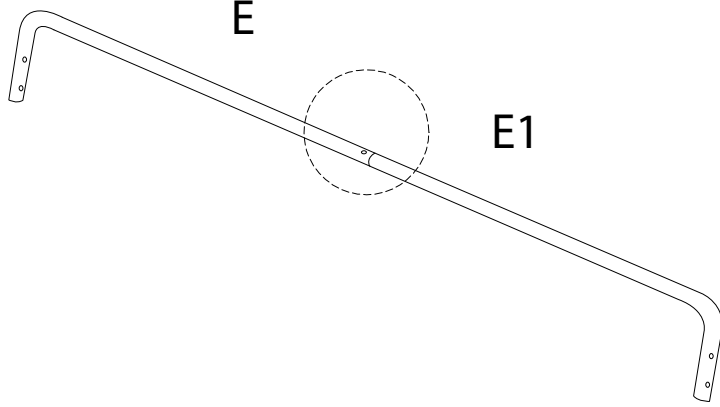
|   |   |   |   |   |   |   |   |
|---|---|---|---|---|---|---|---|
| E   | E1  | O   | R   | W   | Y   | Г   | Δ   |
|  |  |  |  |  |  |  |  |
| x1  | x1  | x1  | x1  | x1  | x1  | x1  | x1  |



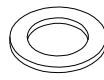
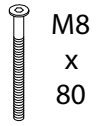
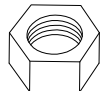
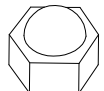

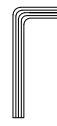

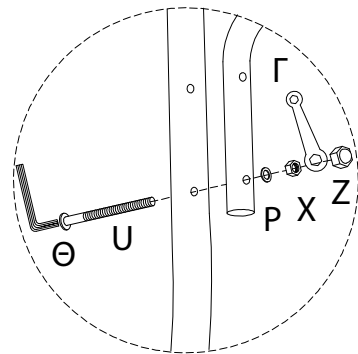
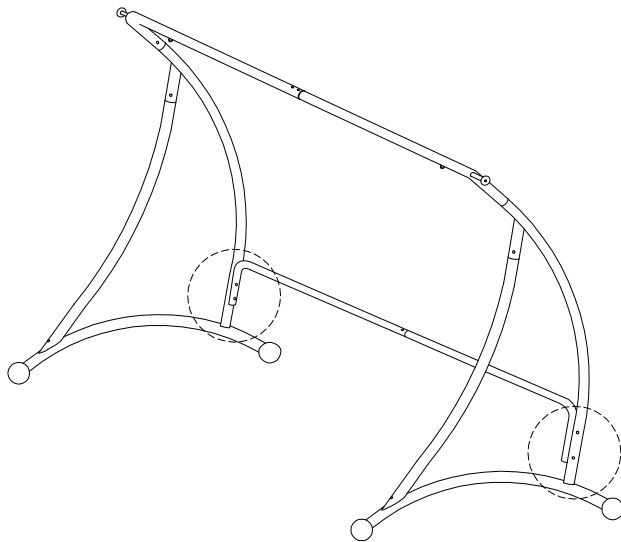
5

|   |   |   |  |   |   |
|---|---|---|--|---|---|
| P   | U   | X   | Z  | Г   | Θ   |
|  |  |  |  |  |  |
| x4  | x4  | x4  | x4   | x1  | x1  |

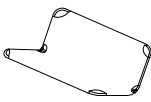
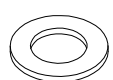
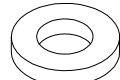
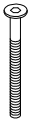

6

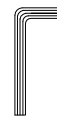
|  |   |  |   |   |
|--|---|--|---|---|
| <p>F</p>  <p>x 2</p>                        | <p>K</p>  <p>x 1</p> | <p>O</p>  <p>x 6</p> | <p>Q</p>  <p>x 6</p> |   |
| <p>S</p>  <p>M6<br/>x<br/>70</p> <p>x 6</p> | <p>W</p>  <p>x 6</p> | <p>Y</p>  <p>x 10</p> | <p>Г</p>  <p>x 1</p> | <p>Δ</p>  <p>x 1</p> |

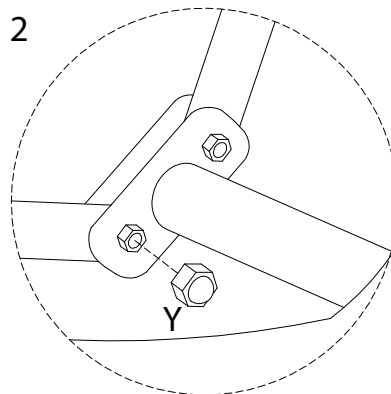
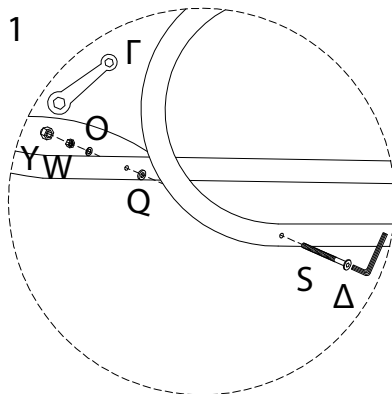
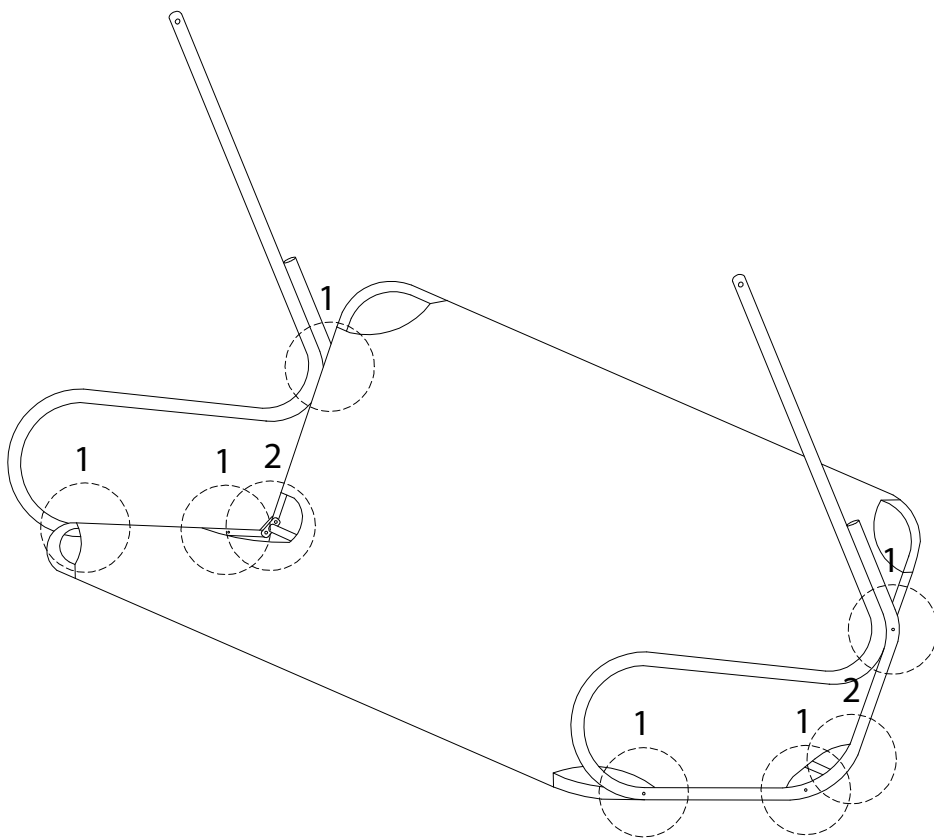



7

M  
  
x 2

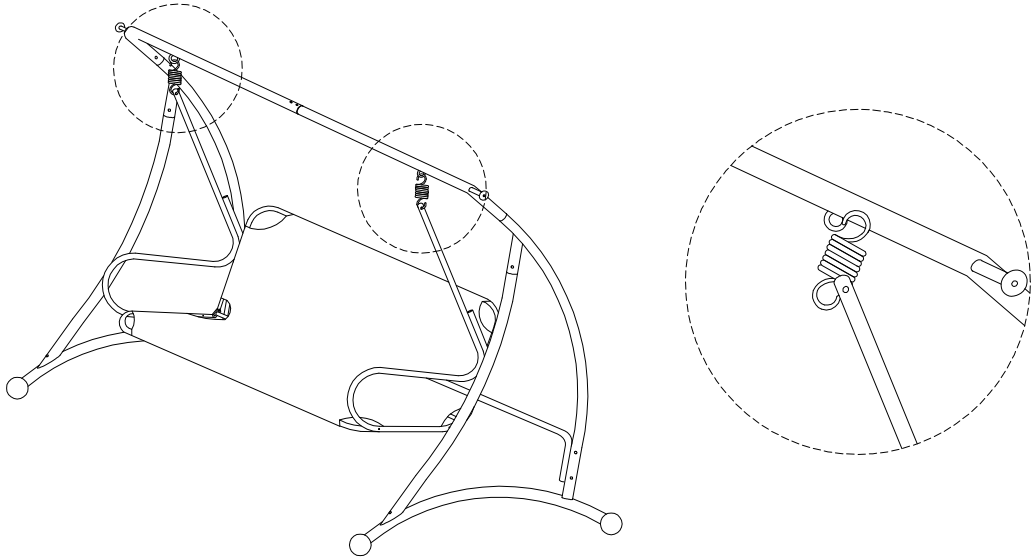

8

I  
  
x 2

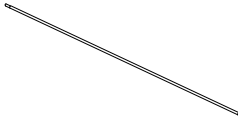
J  
  
x 2

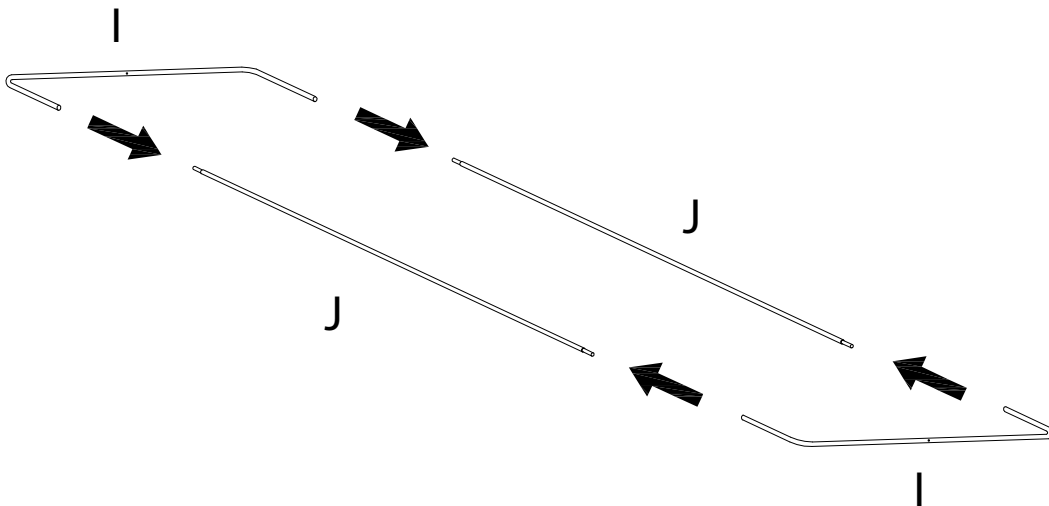

9

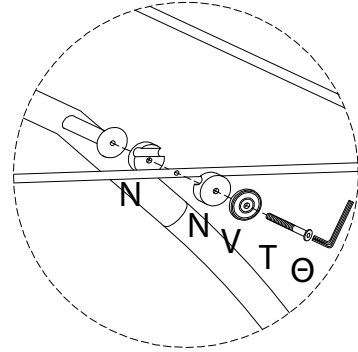
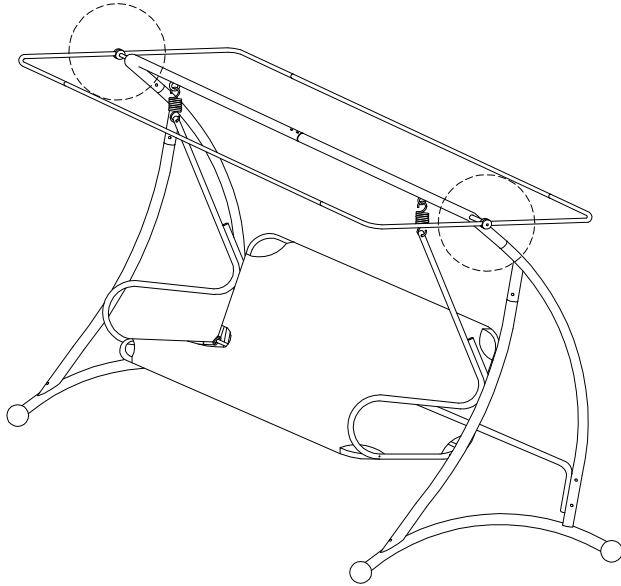
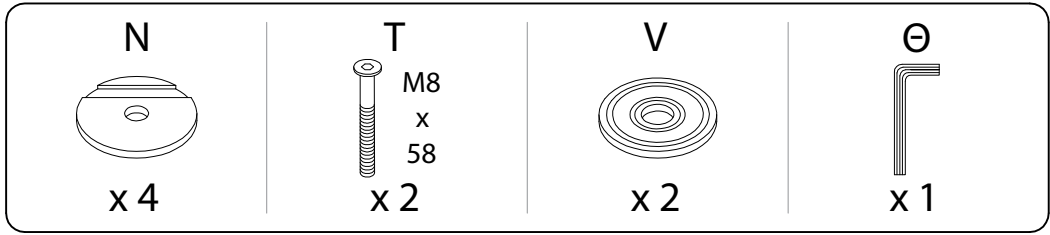

10

