

		1

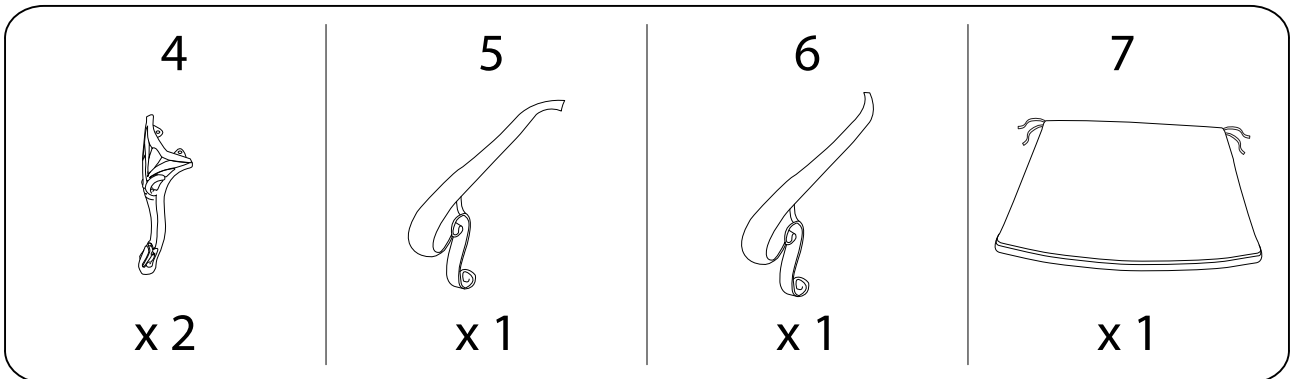

A

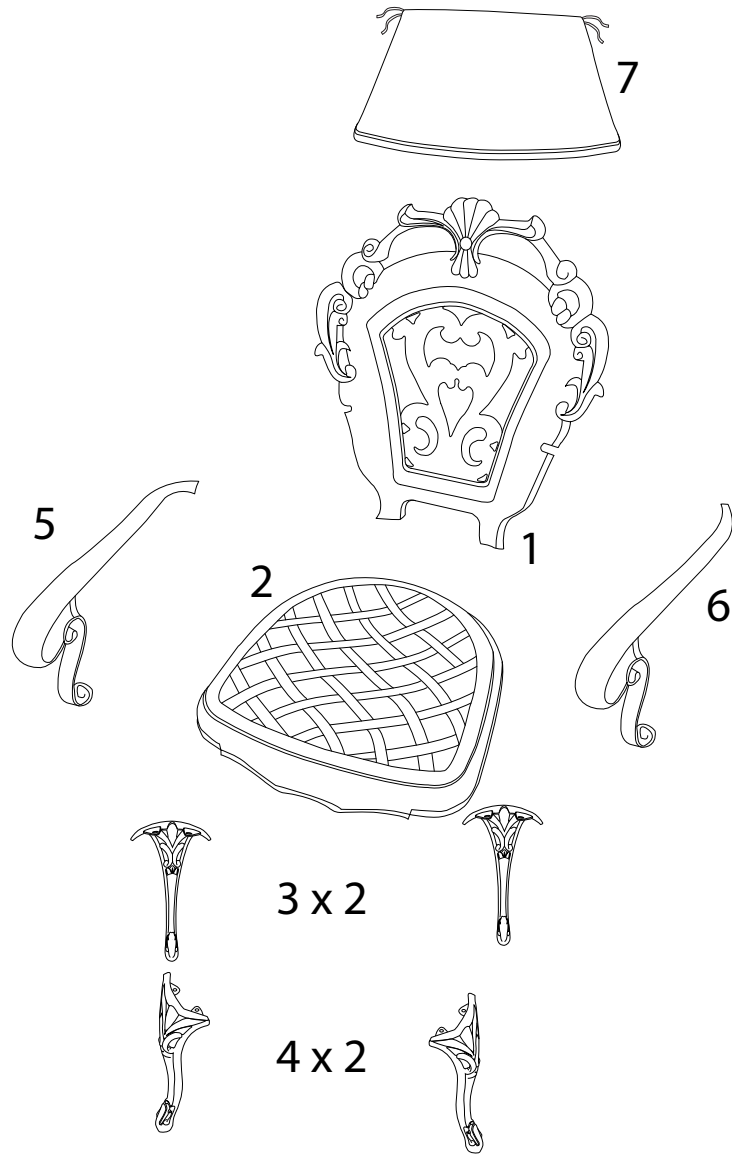
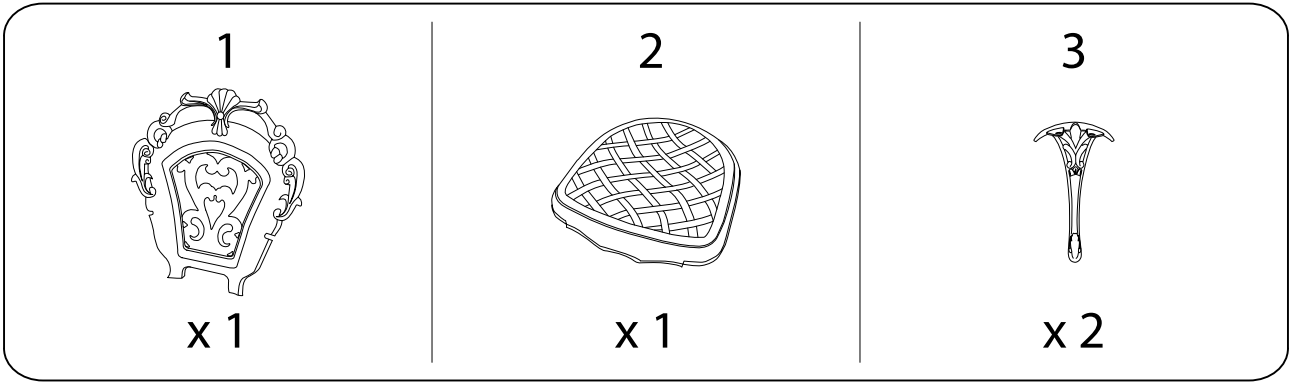
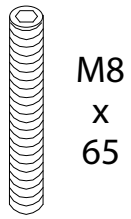

x 2

B

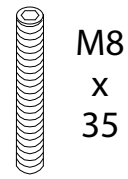

x 8

C

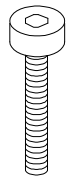

x 2

D

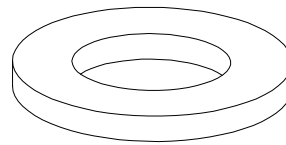

x 10

E

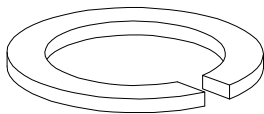

x 10

F

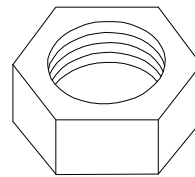

x 10

G

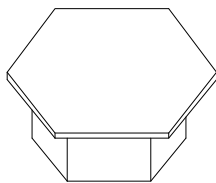

x 10

H

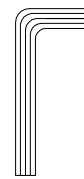

x 1

I

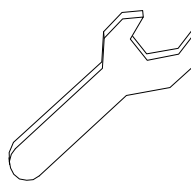

x 1

1

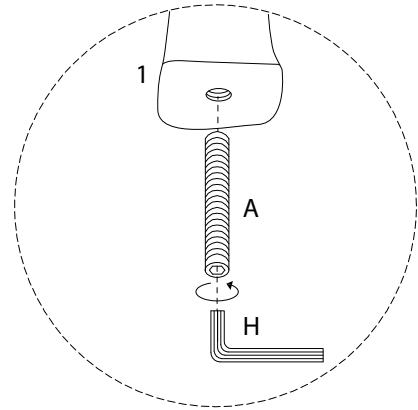
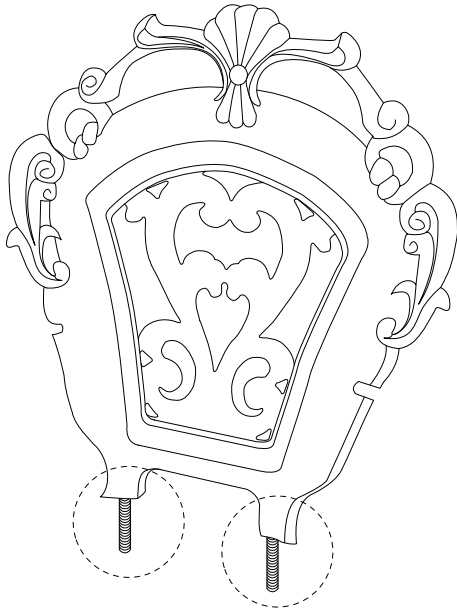
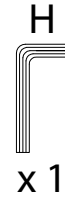
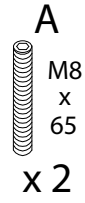

2

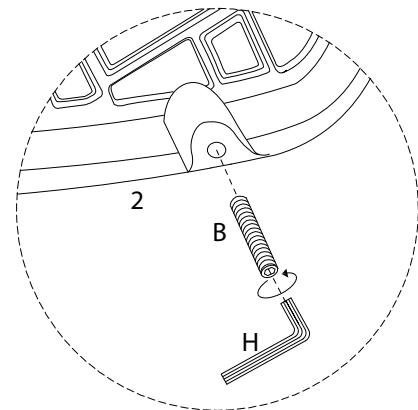
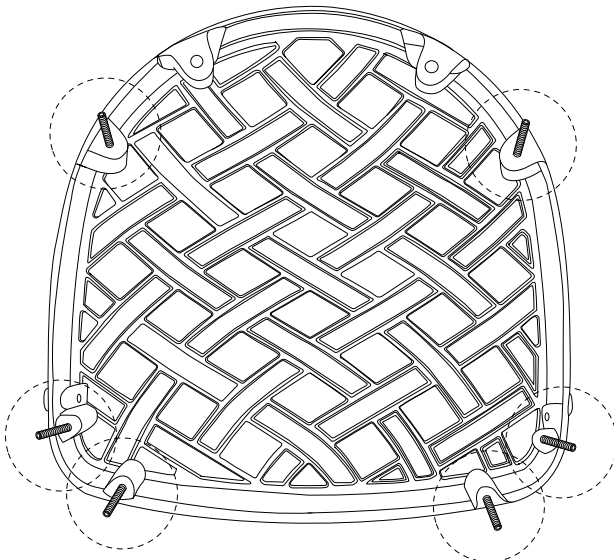
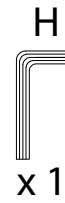
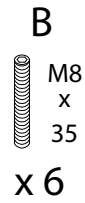
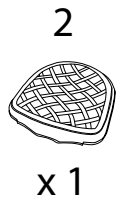

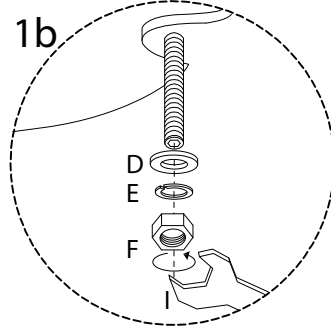
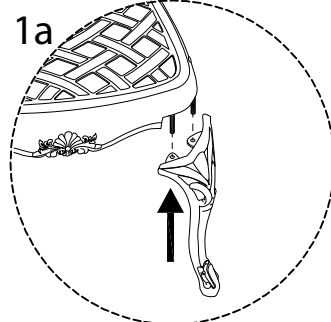
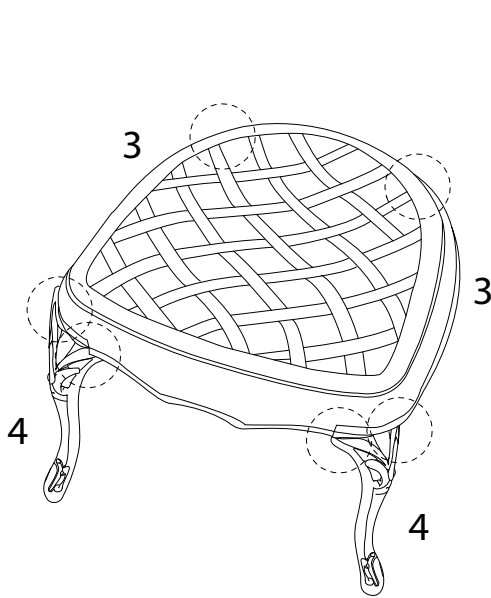
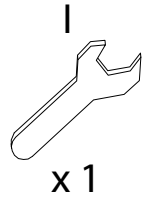
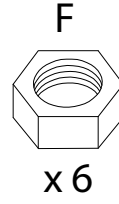
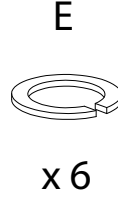
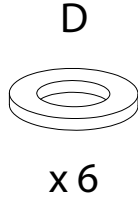

3

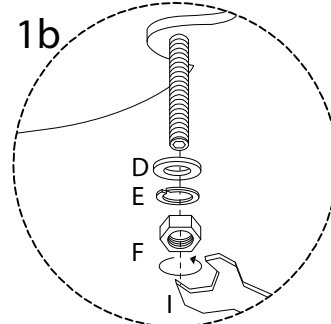
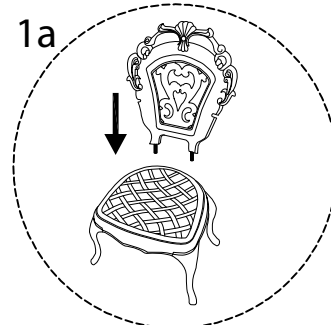
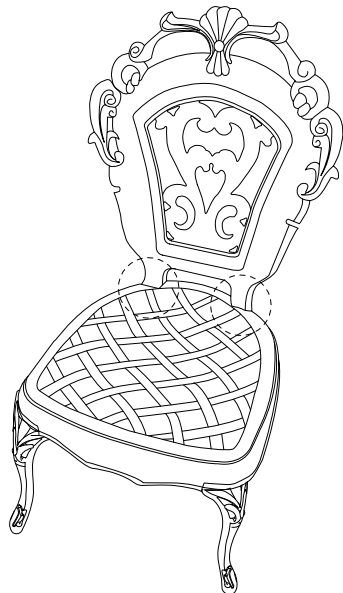
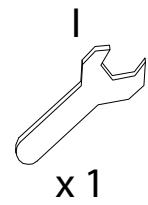
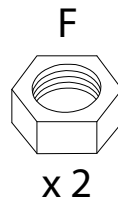
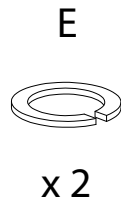
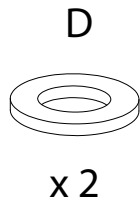

4





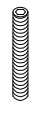
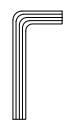

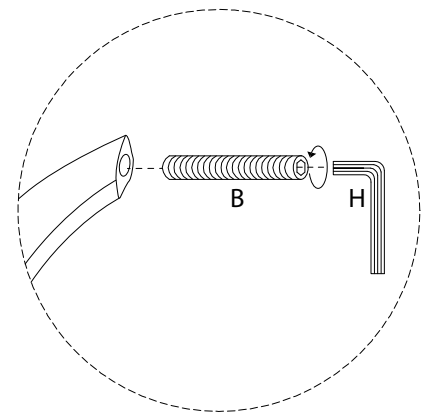
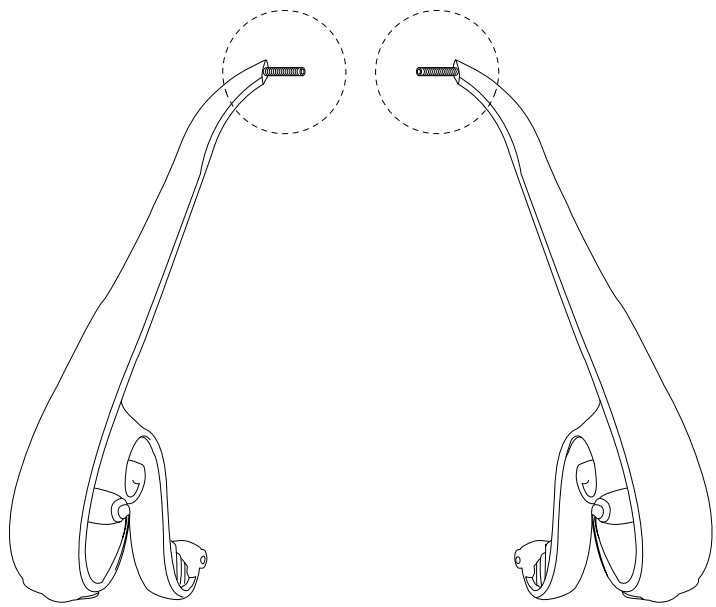
5

<p>5</p>  <p>x1</p>	<p>6</p>  <p>x1</p>	<p>B</p>  <p>M8 x 35</p> <p>x2</p>	<p>H</p>  <p>x1</p>
--	--	--	--

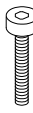

6

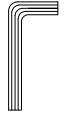
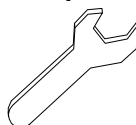
<p>C</p>  <p>x2</p>	<p>D</p>  <p>x2</p>	<p>E</p>  <p>x2</p>	<p>F</p>  <p>x2</p>	<p>H</p>  <p>x1</p>	<p>I</p>  <p>x1</p>
--	--	--	---	--	--

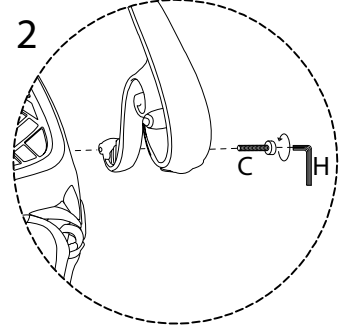
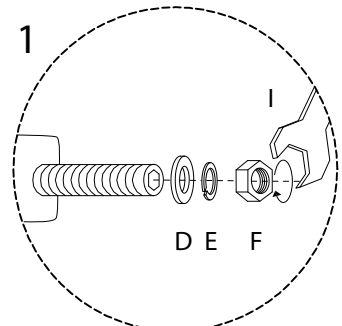
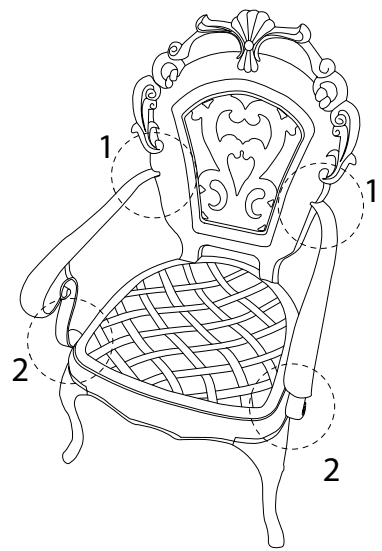

7

G

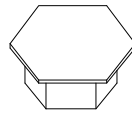

x 10

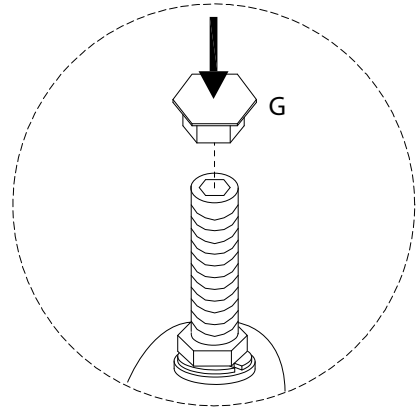
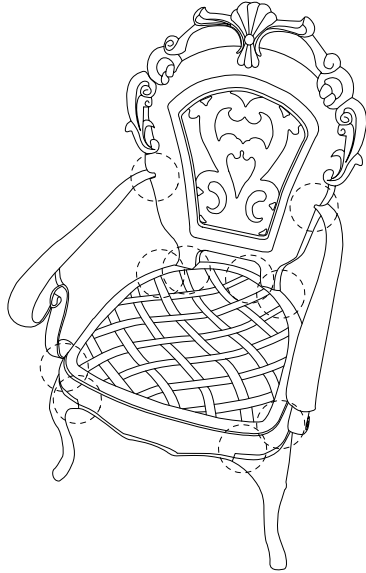

8

7



x 1

