

GENFEL

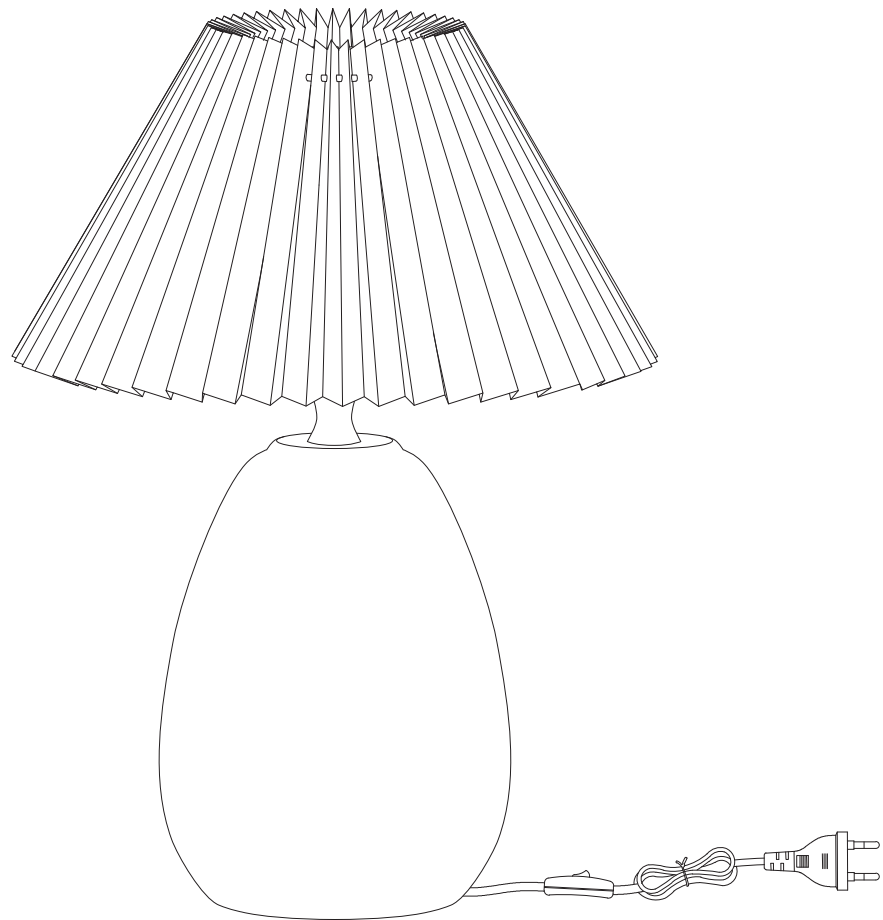

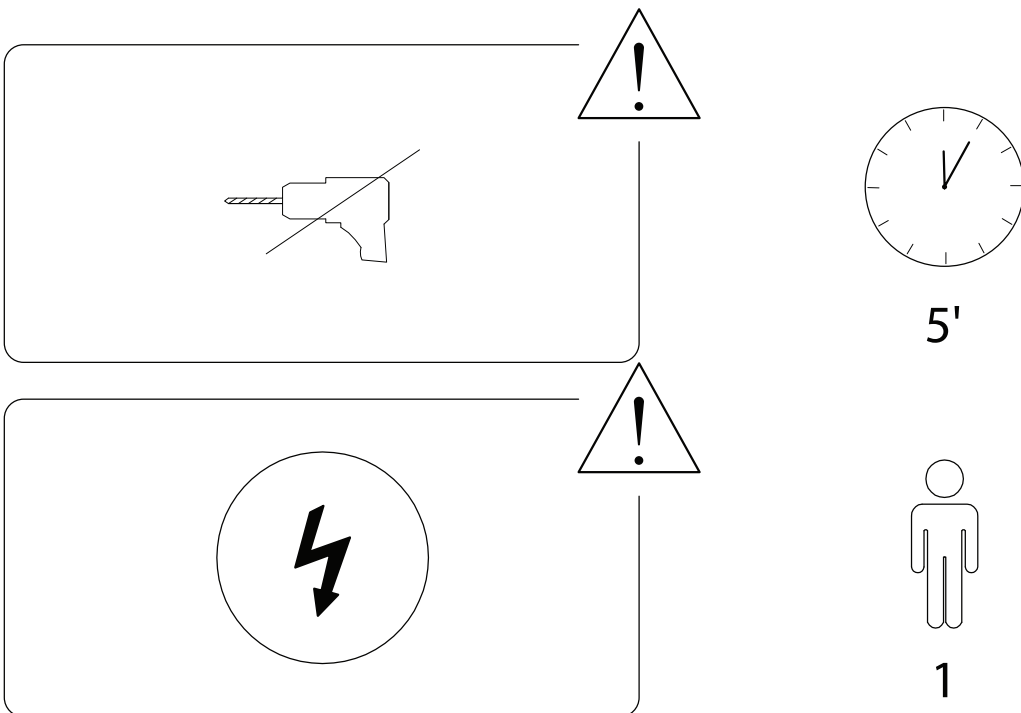

C 

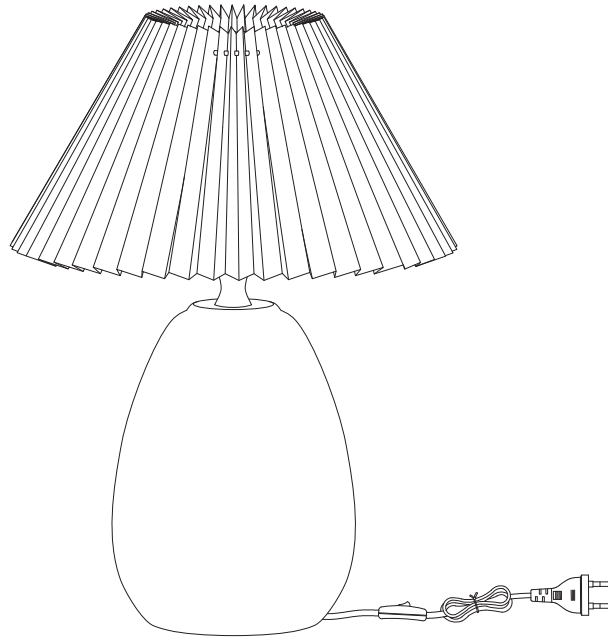
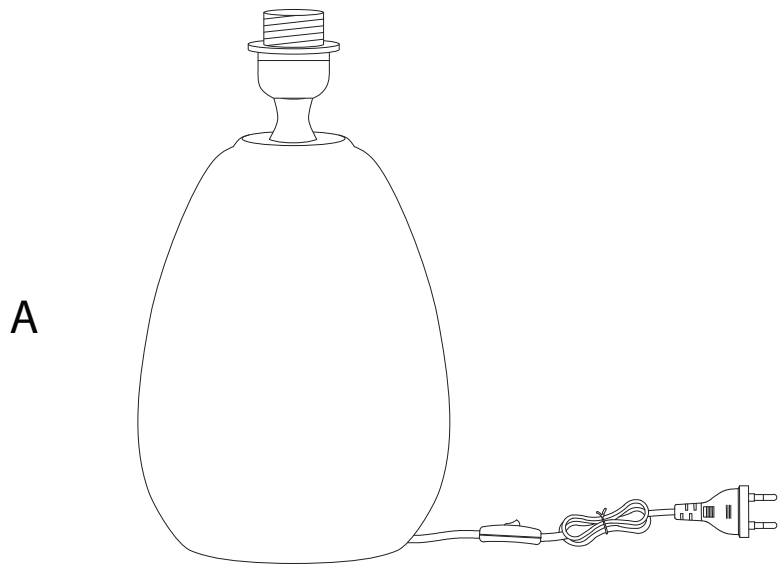
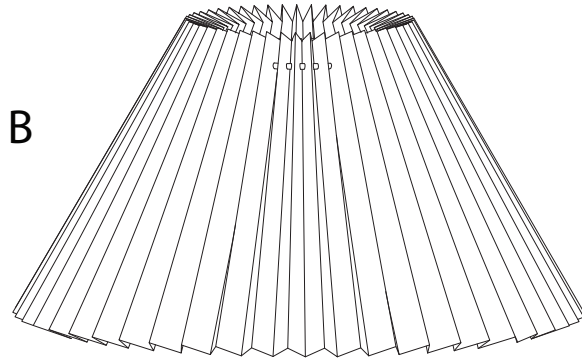

A

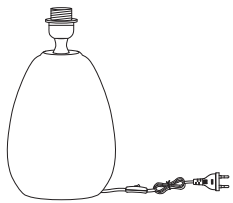

x 1

B

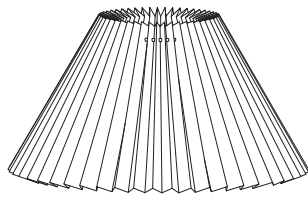

x 1

C

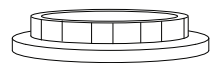

x 1

!

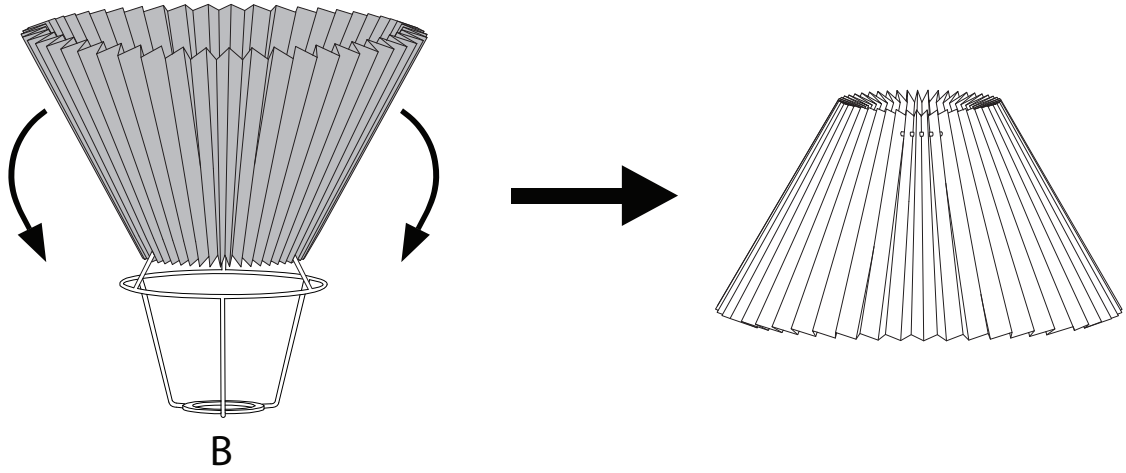

1

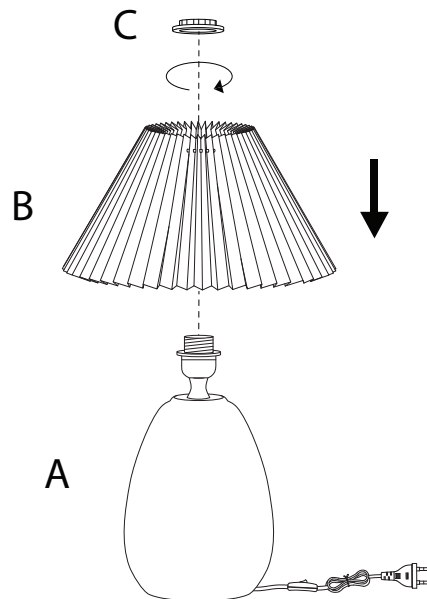
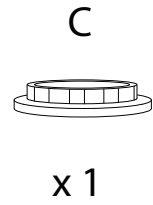
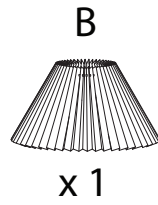

2

