

30'

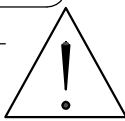
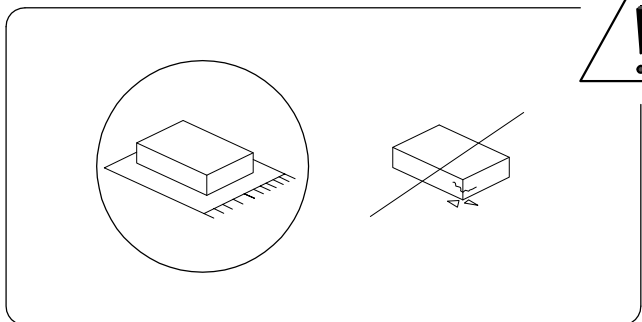

1

1/3

A

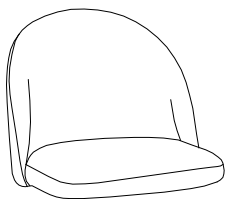

x 1

B



x 1

A

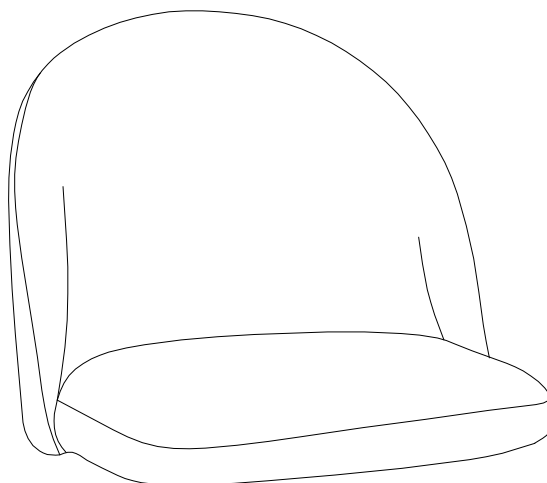

B

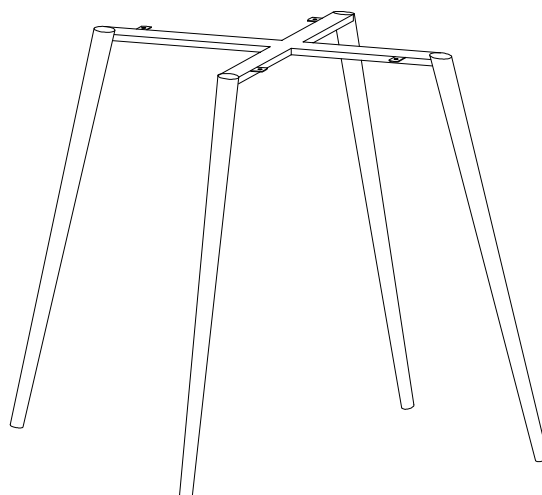

C



x 4

D

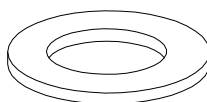

x 4

E



x 1

1

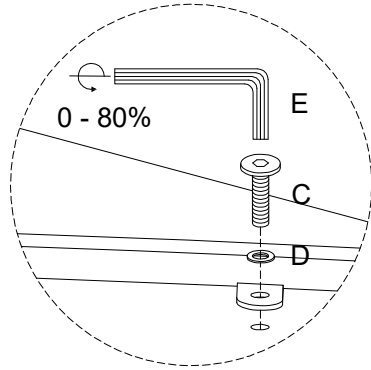
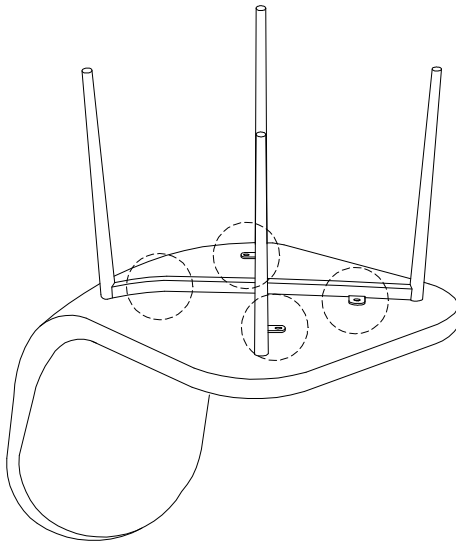
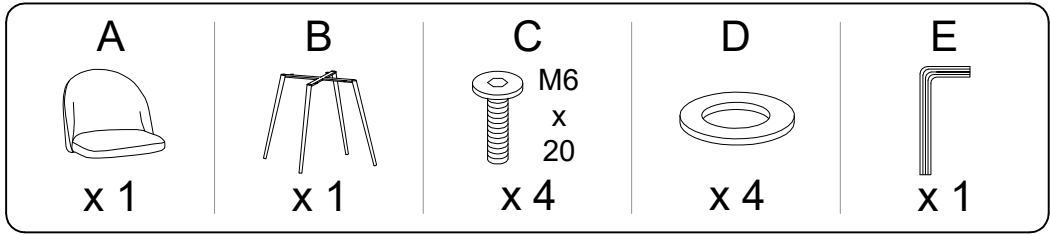

2

