

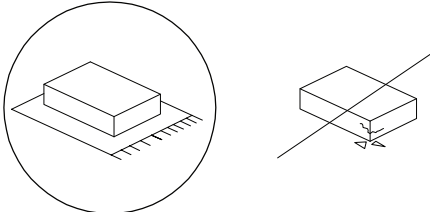

		<b>40'</b>
		
		<b>2</b>

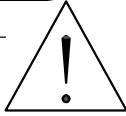

A

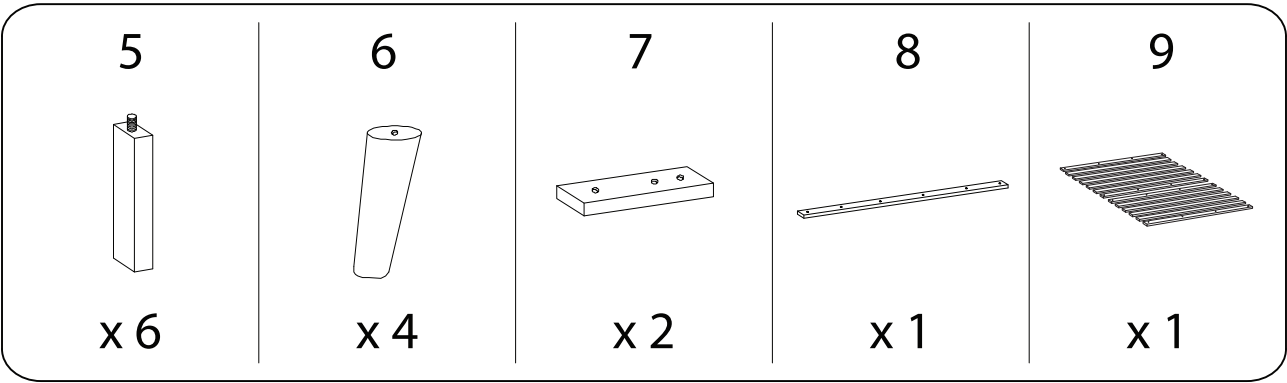
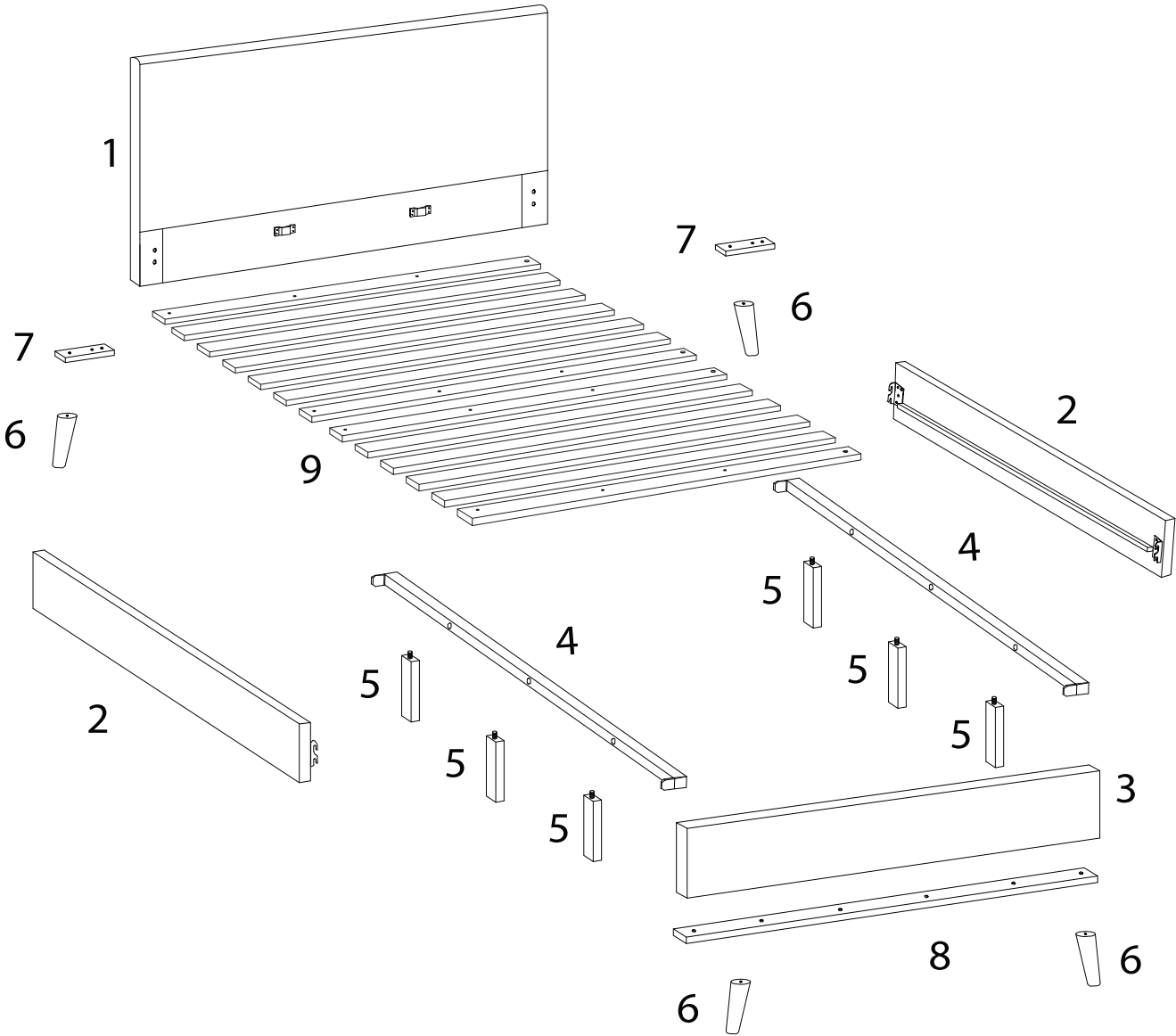
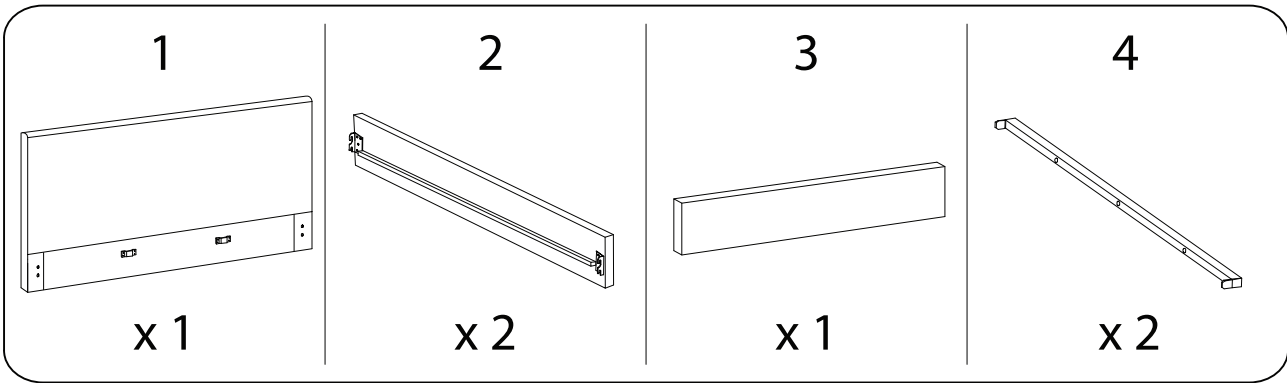
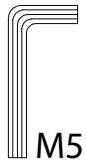

x 1

B

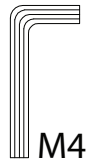

x 1

C

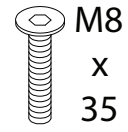

x 4

D

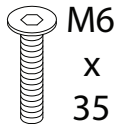

x 8

E

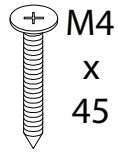

x 4

F

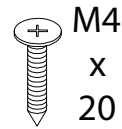



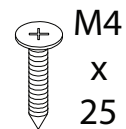

x 4

G





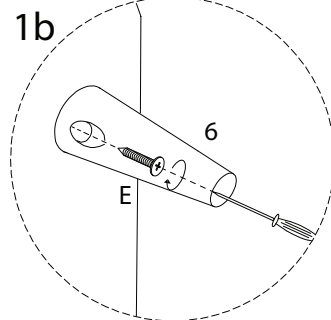
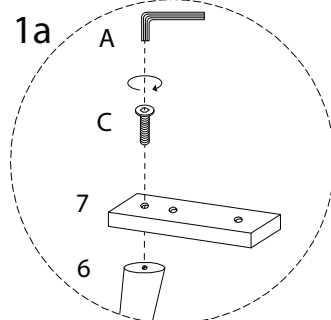
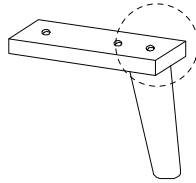
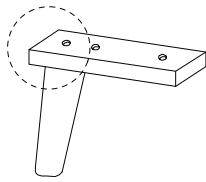

x 16

1

<p>6</p>  <p>x 2</p>	<p>7</p>  <p>x 2</p>	<p>A</p>  <p>M5</p> <p>x 1</p>	<p>C</p>  <p>M8 x 35</p> <p>x 2</p>	<p>E</p>  <p>M4 x 45</p> <p>x 2</p>
---	---	---	--	--



2

<p>6</p>  <p>x 2</p>	<p>8</p>  <p>x 1</p>	<p>A</p>  <p>M5</p> <p>x 1</p>	<p>C</p>  <p>M8 x 35</p> <p>x 2</p>	<p>E</p>  <p>M4 x 45</p> <p>x 2</p>
---	---	---	--	--

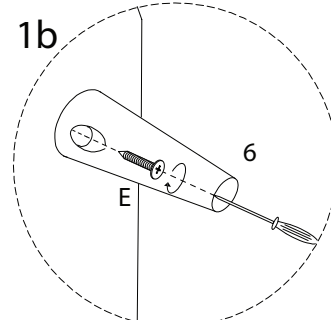
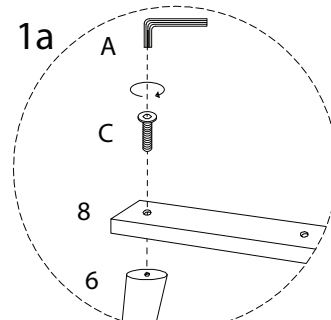
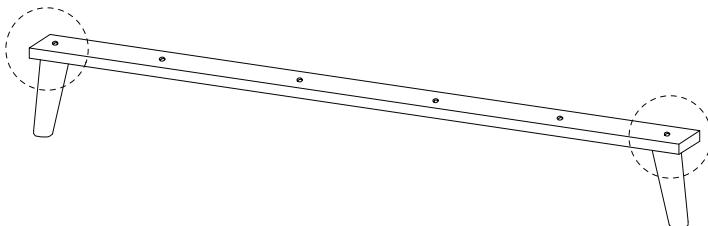

3

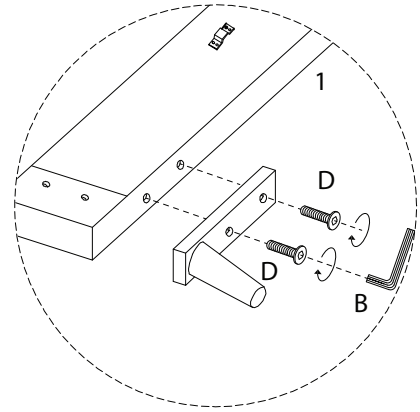
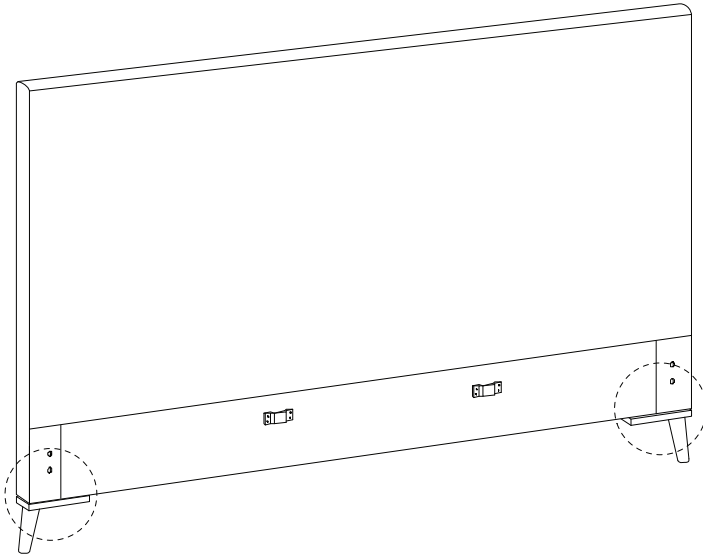
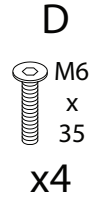
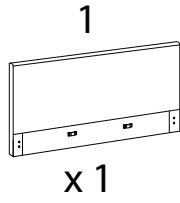

4

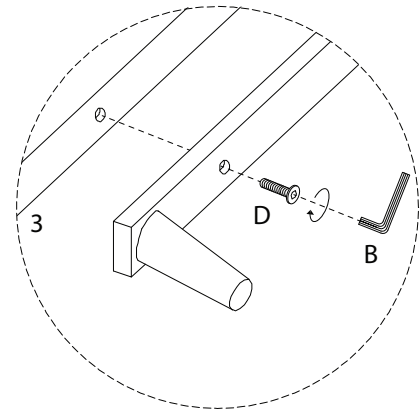
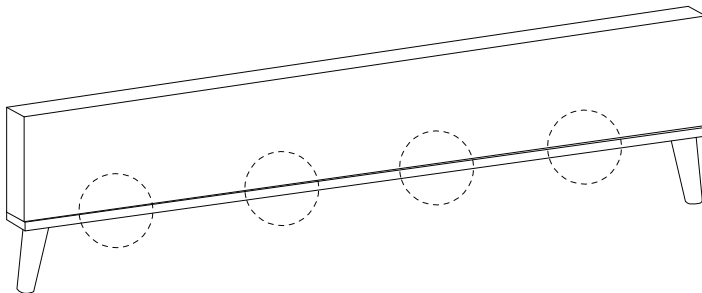
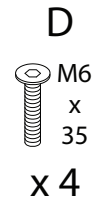
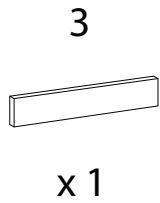

5 x 2

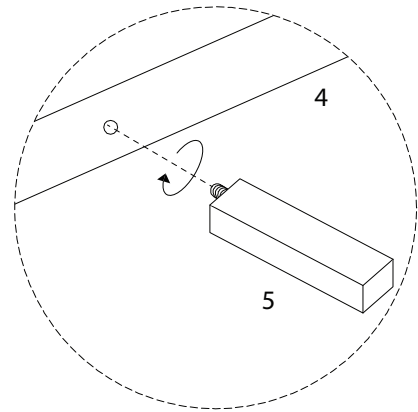
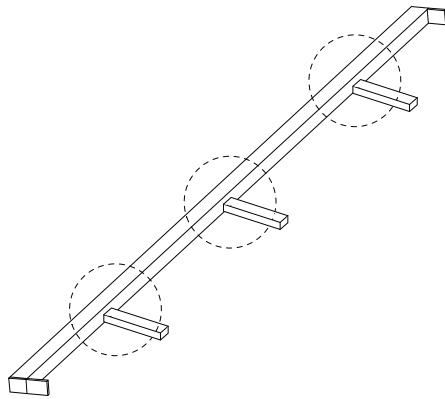
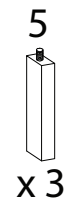
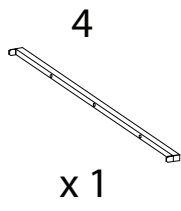

6

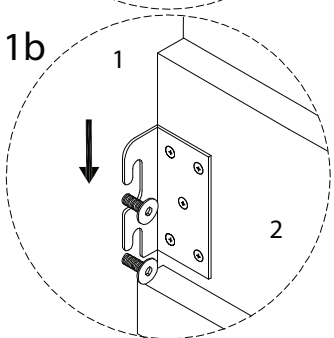
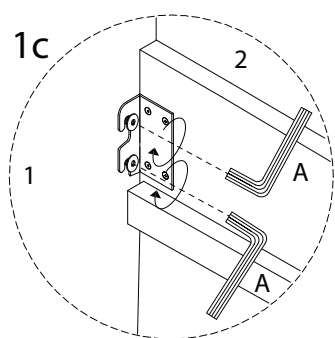
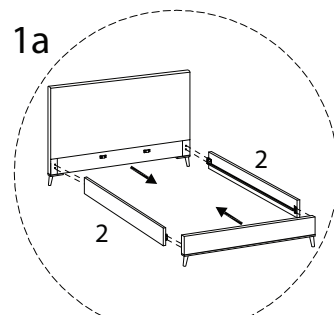
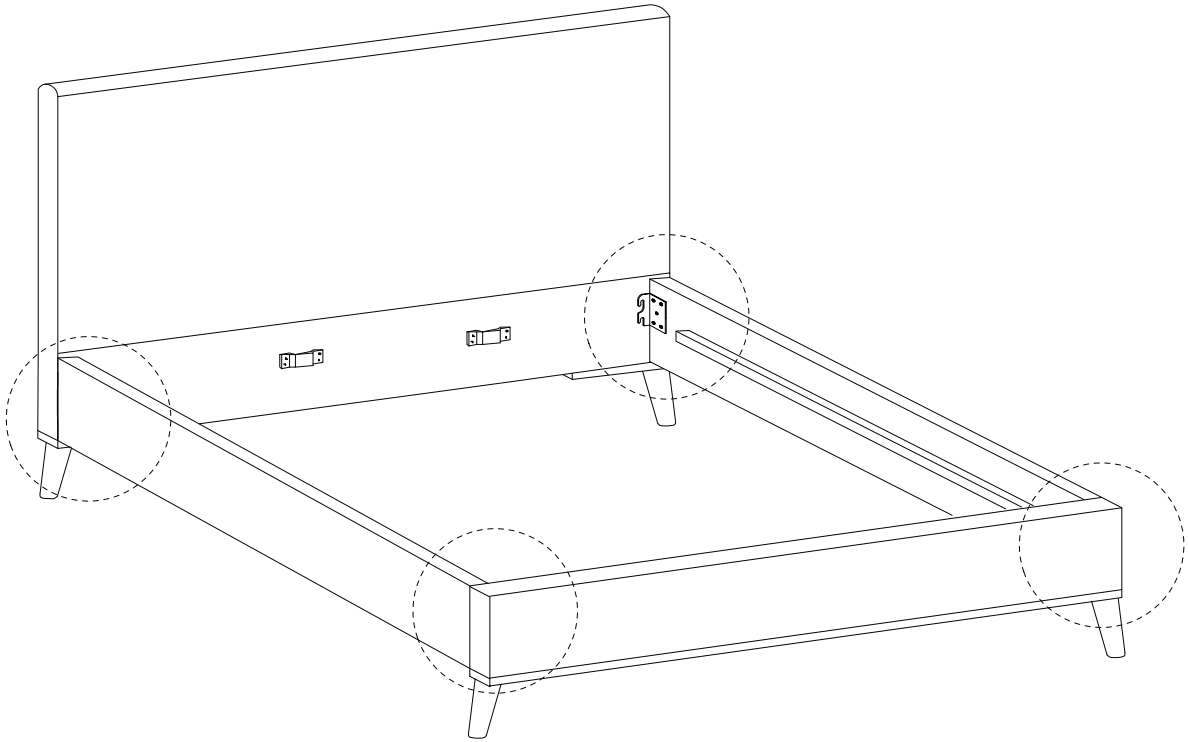
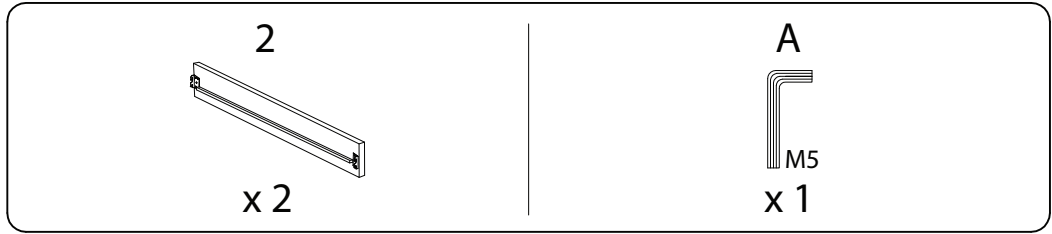

7

F

M4  
x  
20  
x 4

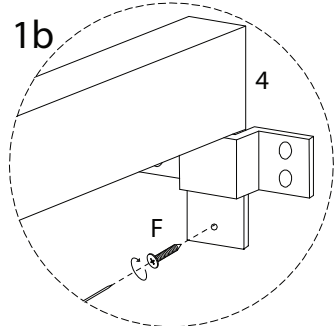
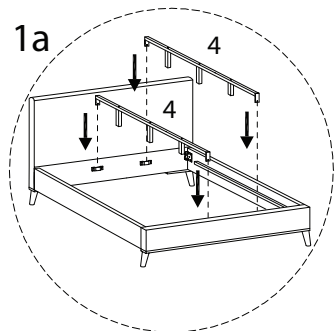
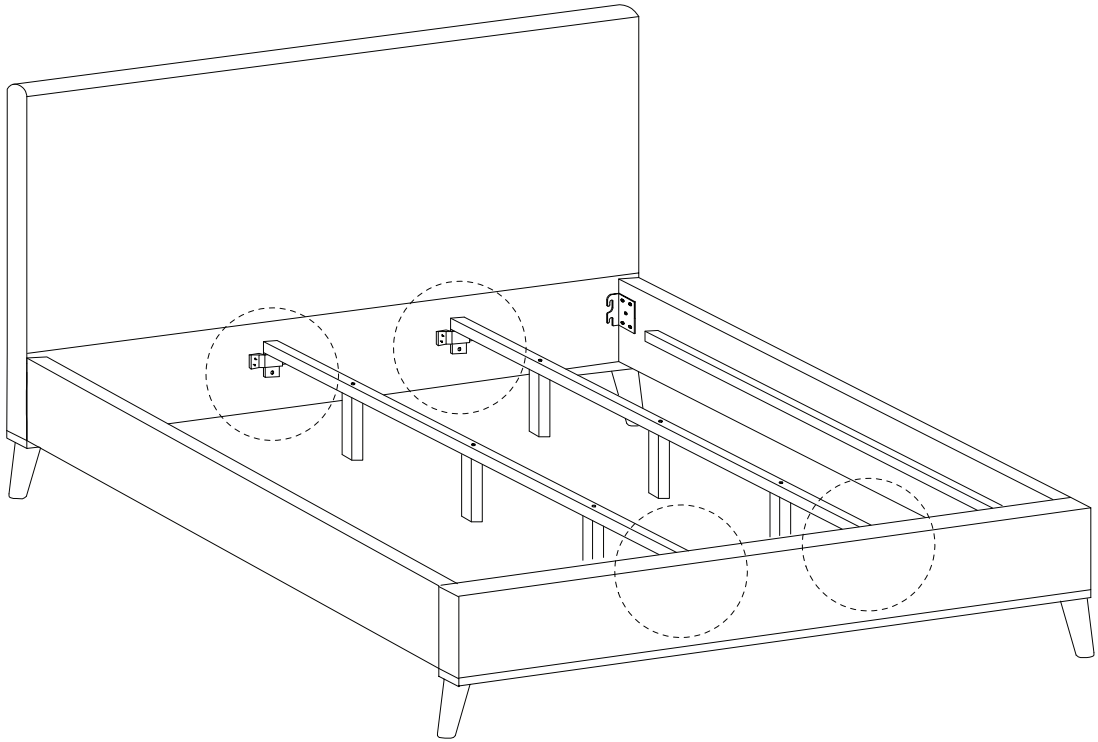



8

9



x 1

G



x 16

