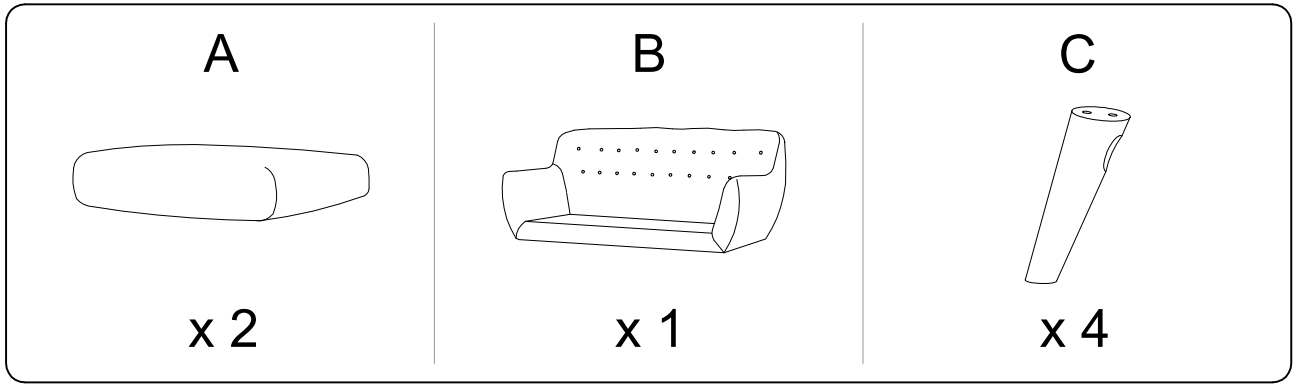
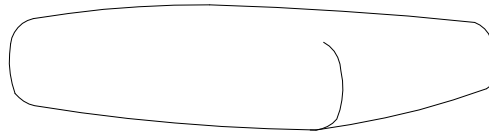

Diagram illustrating assembly instructions and safety warnings:

- Warning 1:** A triangle with an exclamation mark points to a box containing:
 - An icon of an L-shaped metal bracket.
 - An icon of a power drill with a slash through it, indicating that a power drill should not be used.
- Warning 2:** A triangle with an exclamation mark points to a box containing:
 - An icon of a rectangular block being placed on a surface.
 - An icon of a rectangular block with a slash through it, indicating that the block should not be placed on a soft surface like a rug.
- Time:** A clock icon is shown next to the number **20'**, indicating an estimated assembly time of 20 minutes.
- Personnel:** An icon of a person is shown next to the number **2**, indicating that two people are required for assembly.



A x 2



B

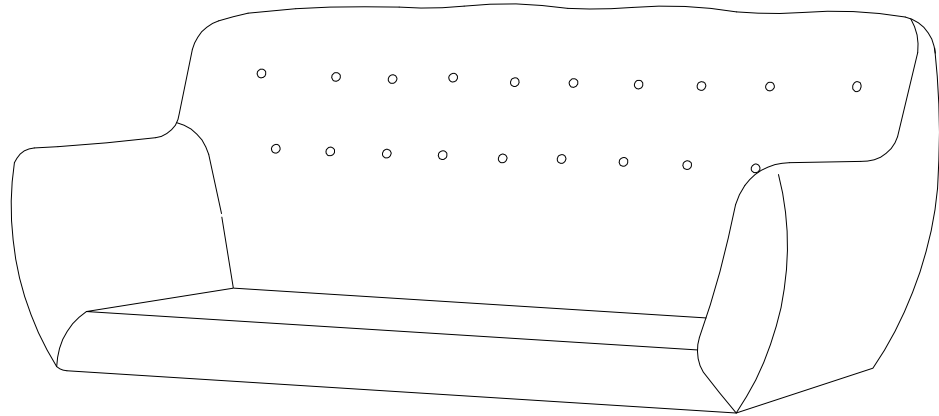

C x 4

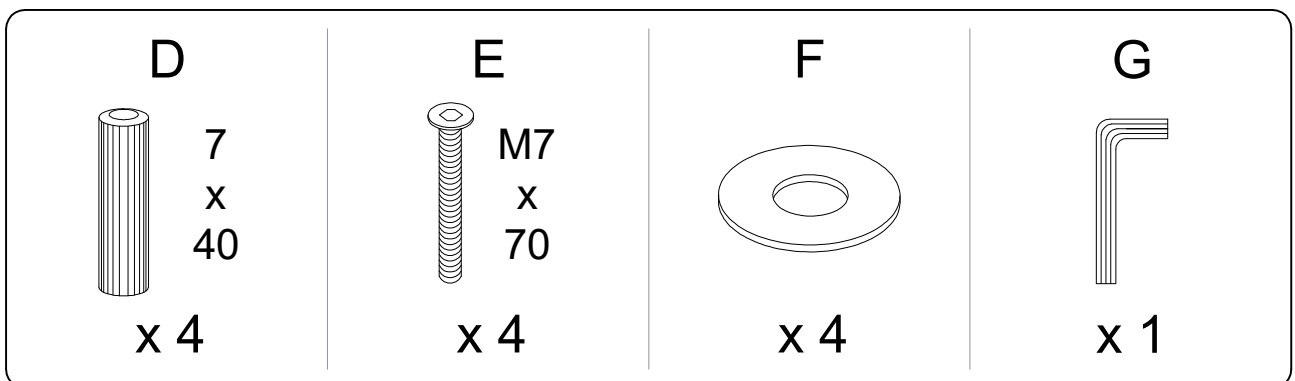

!

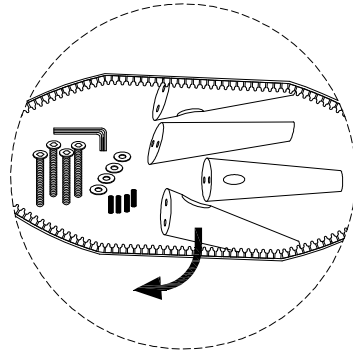
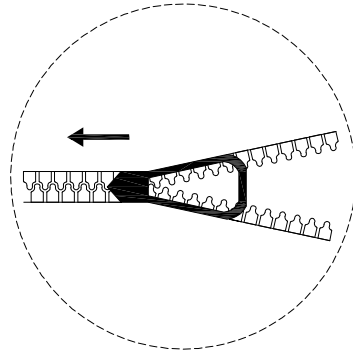
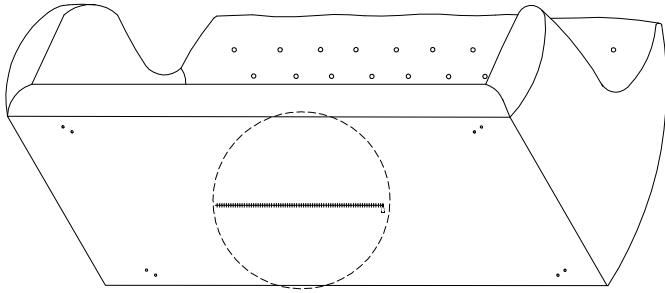

1

C



x 4

D



7
x
40

x 4

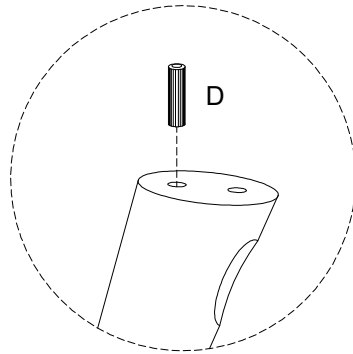
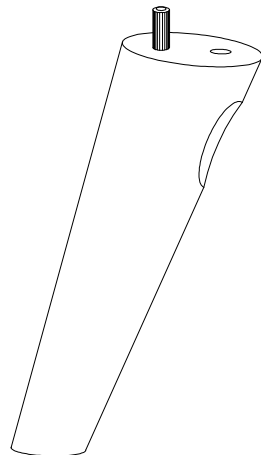

2

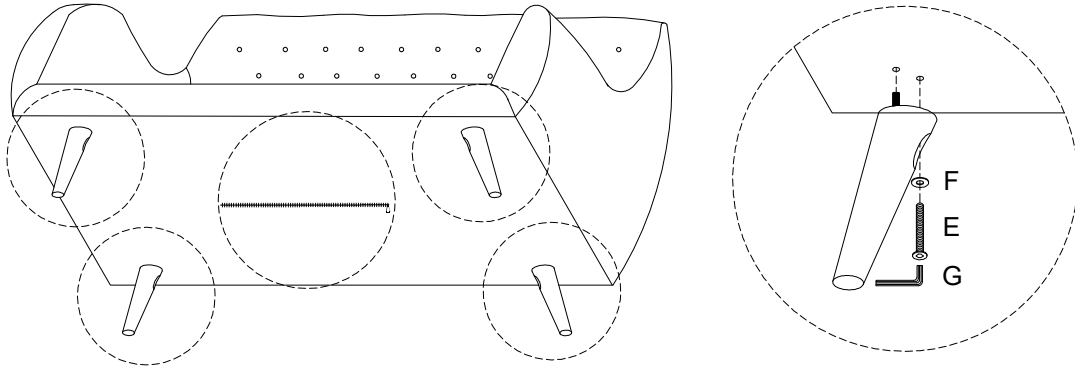
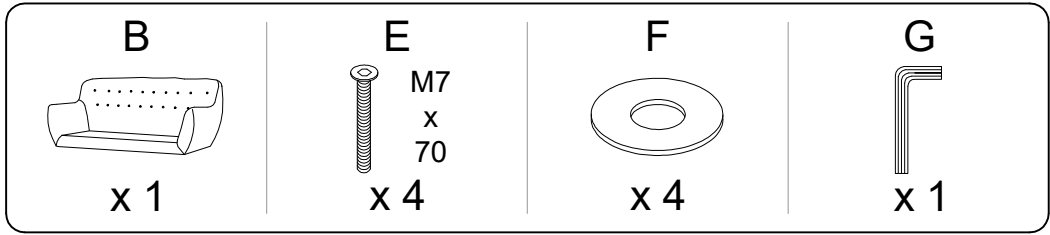

3

