

		45'
		
		2

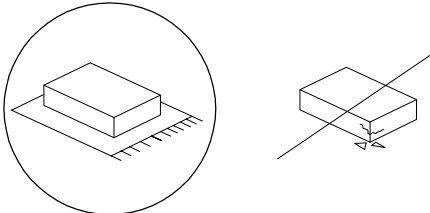

F

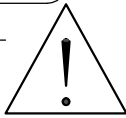
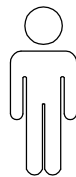
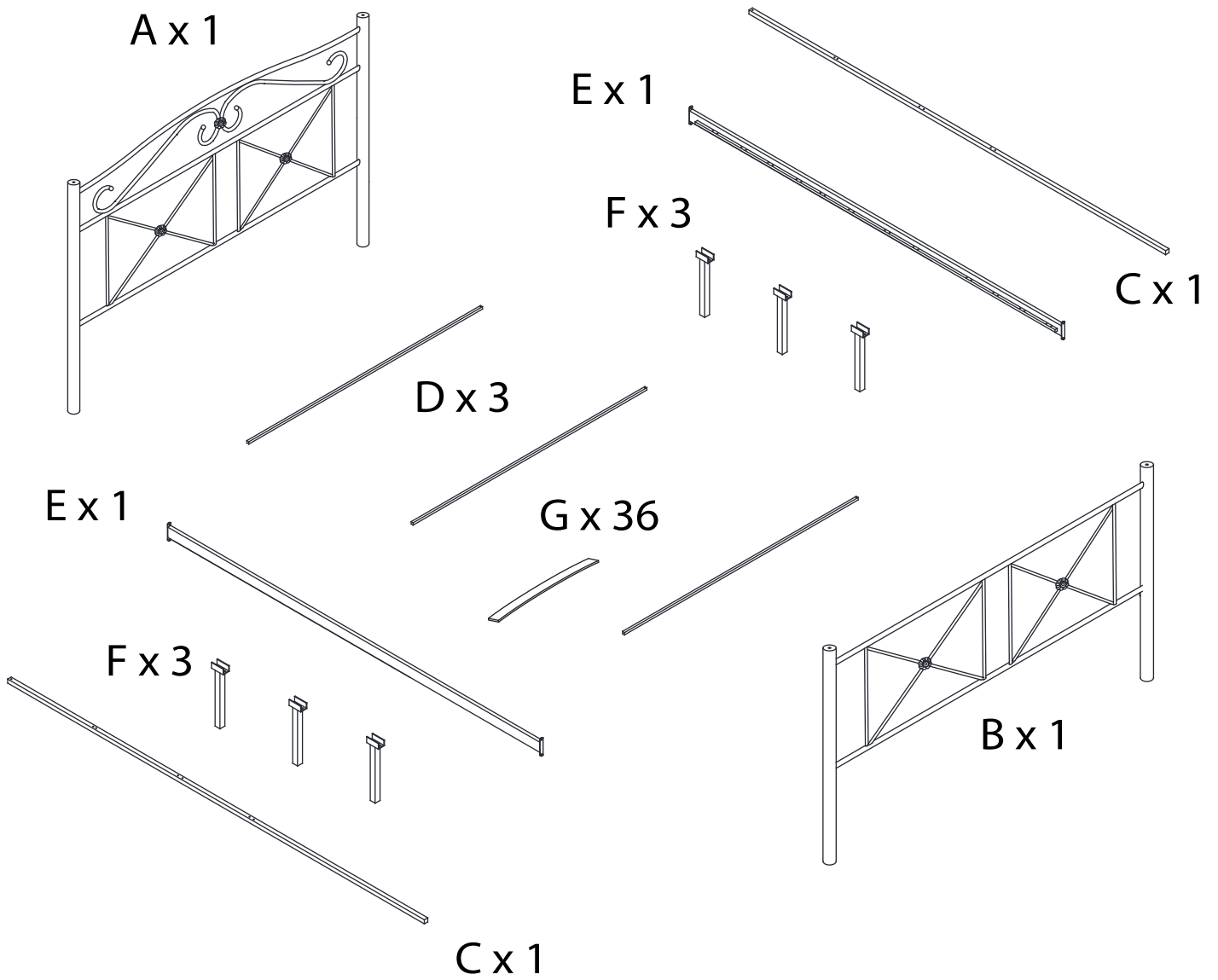
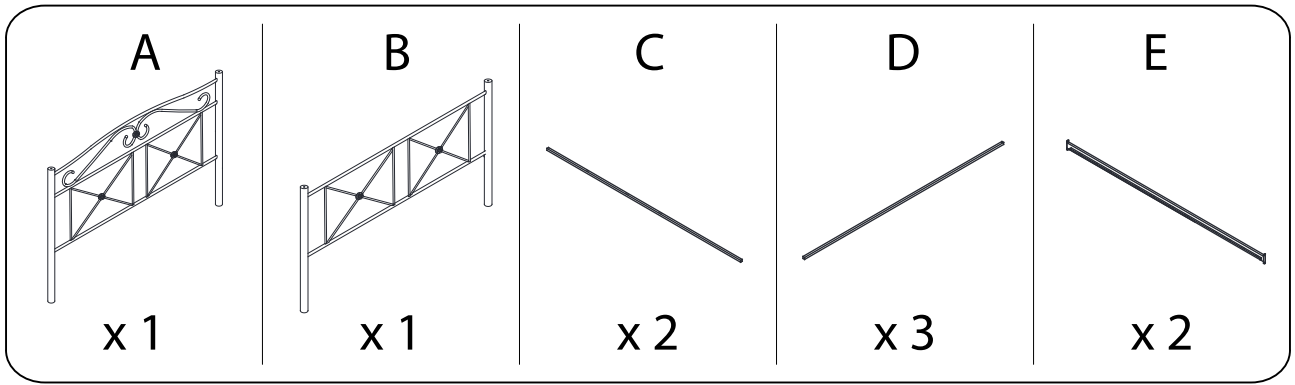
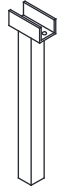

x 6

G

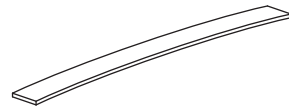

x 36

H



x 4

I

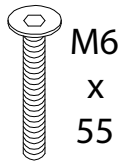

M6
x
55

x 6

J

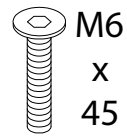

M6
x
45

x 6

K

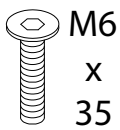

M6
x
35

x 10

L

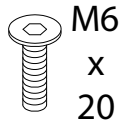

M6
x
20

x 8

M

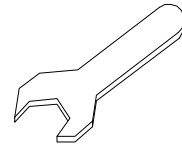

x 1

N

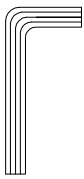

x 1

O

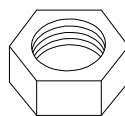

x 22

P

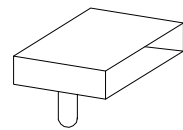

x 24

Q

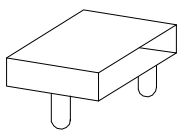

x 24

R

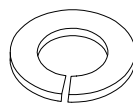

x 8

S

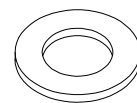

x 24



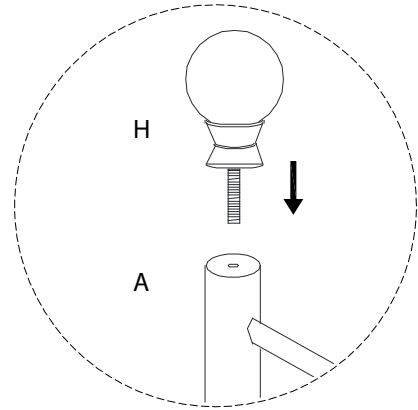
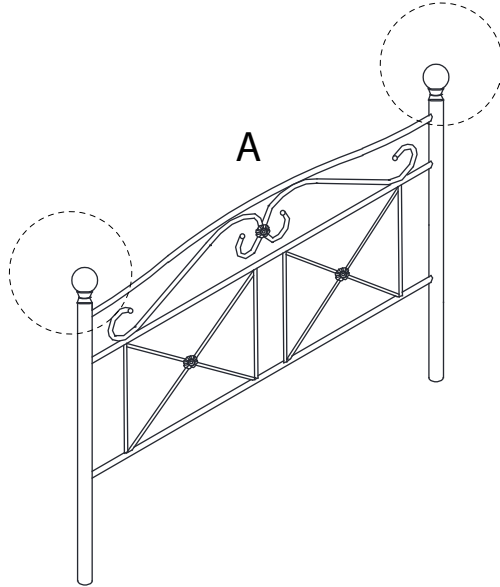
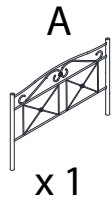

1

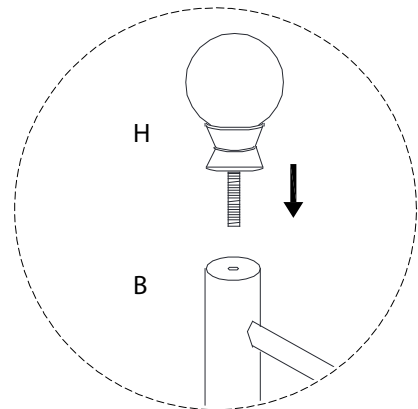
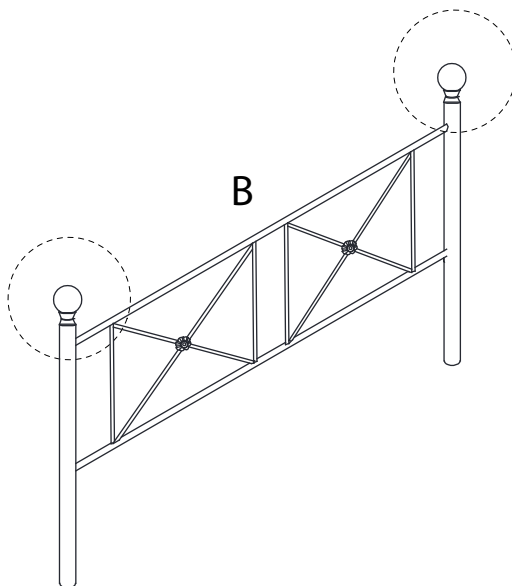
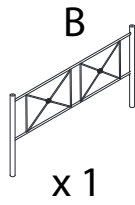

2



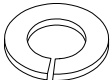

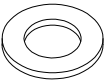

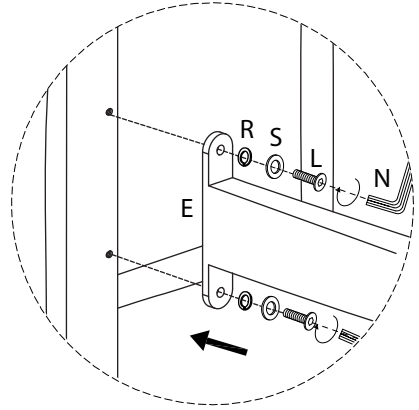
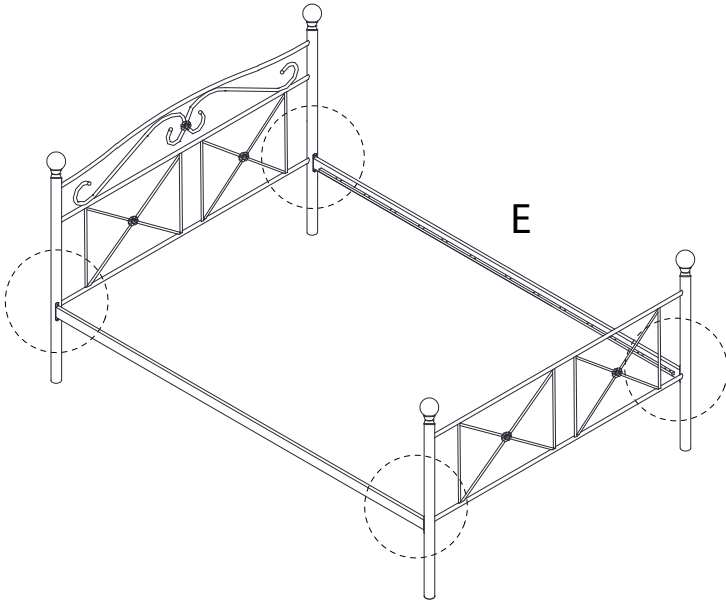
3

<p>E</p>  <p>x 2</p>	<p>L</p>  <p>M6 x 20 x 8</p>	<p>R</p>  <p>x 8</p>	<p>N</p>  <p>x 1</p>	<p>S</p>  <p>x 8</p>
---	---	---	---	---



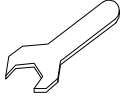

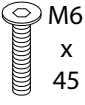
4

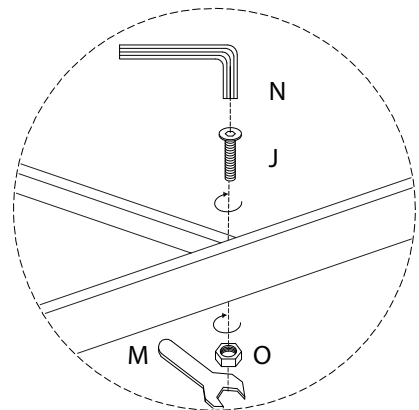
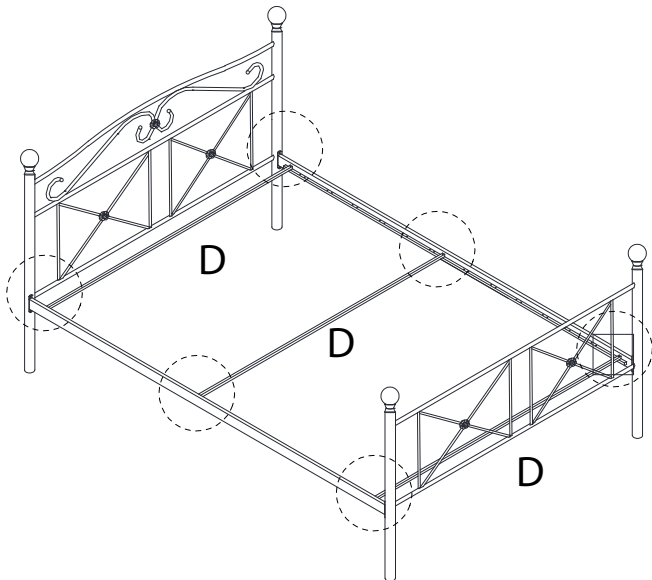
<p>D</p>  <p>x 3</p>	<p>O</p>  <p>x 6</p>	<p>M</p>  <p>x 1</p>	<p>N</p>  <p>x 1</p>	<p>J</p>  <p>M6 x 45 x 6</p>
---	---	---	---	---





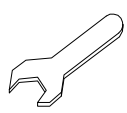
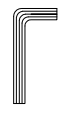
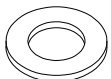
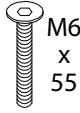

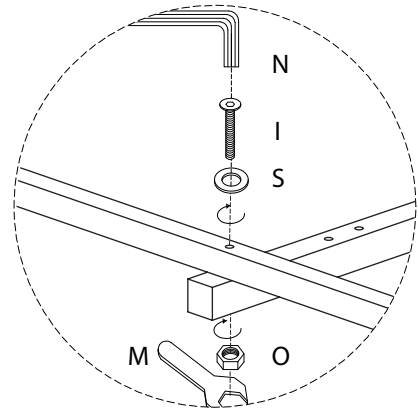
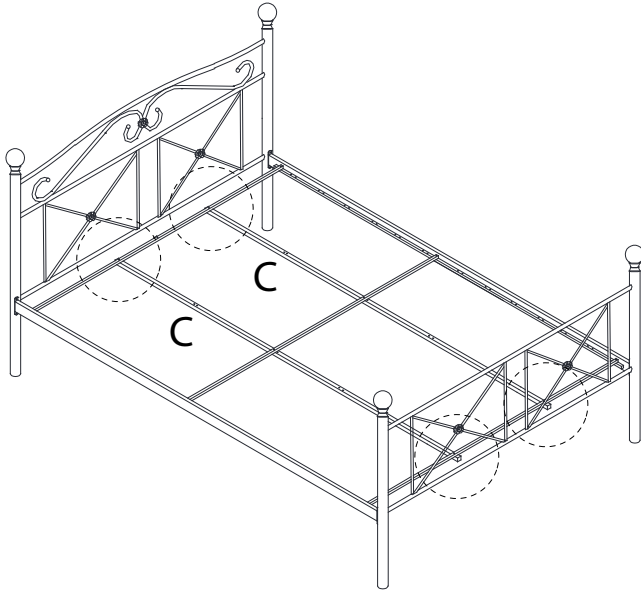
5

C	O	M	N	S	I
					
x 2	x 4	x 1	x 1	x 4	x 4

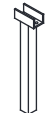

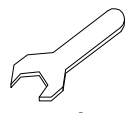
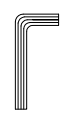
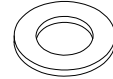
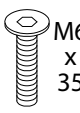
7

F	O	M	N	S	K	I
						
x 6	x 12	x 1	x 1	x 12	x 10	x 2

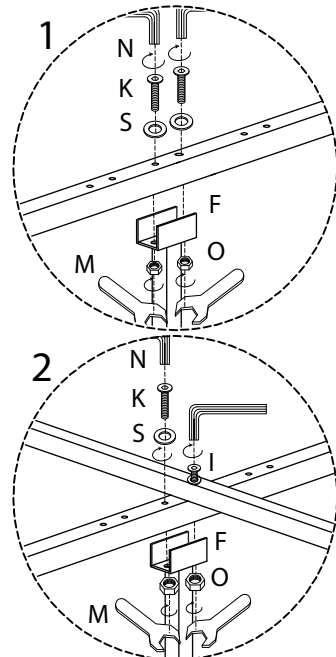
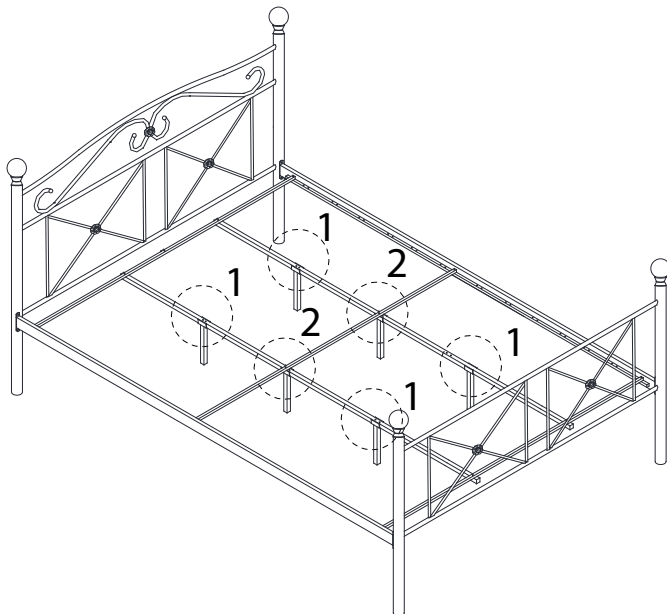

8

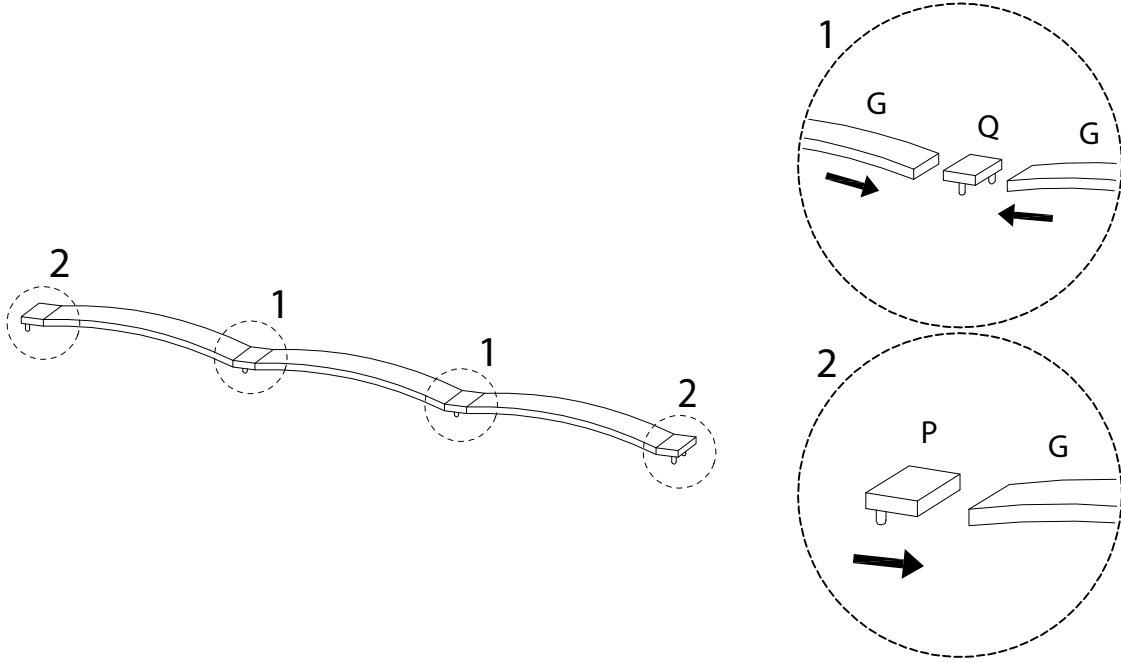
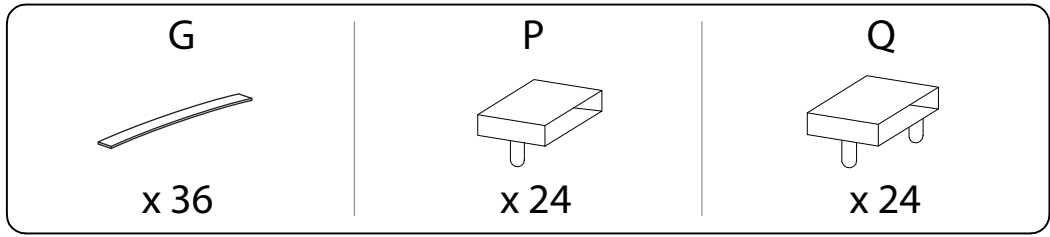

9

