	<b>60'</b>
		
		<b>1</b>

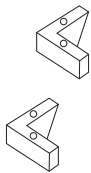

F x 4

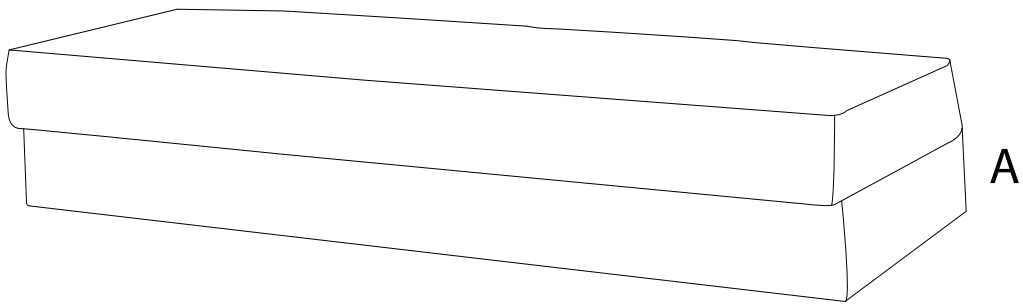

A

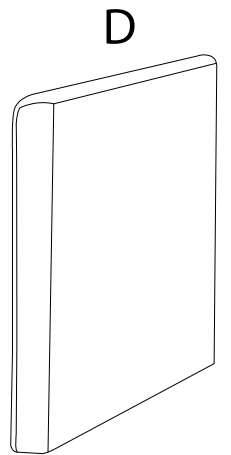
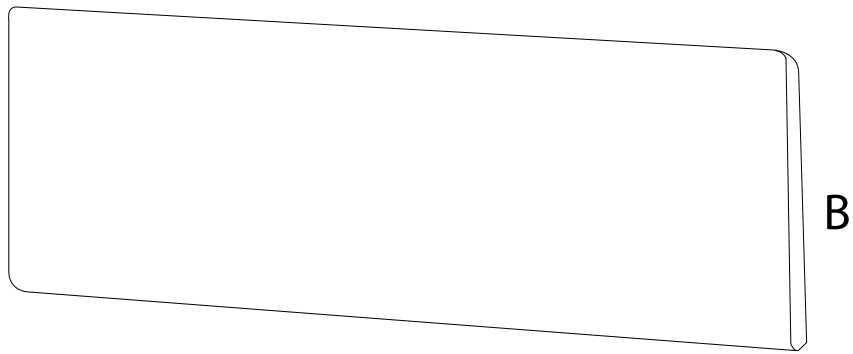
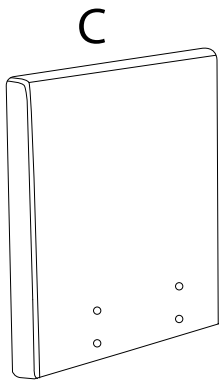
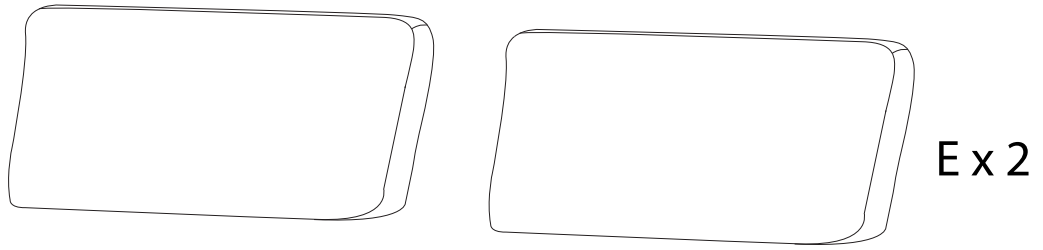
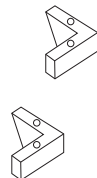
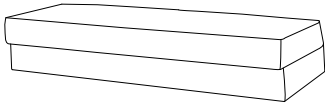

x 1

B

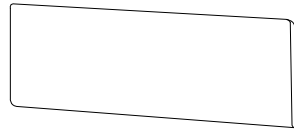

x 1

C

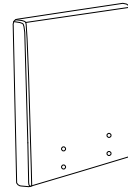

x 1

D

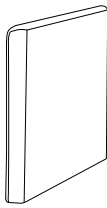

x 1

E

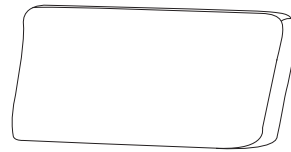

x 2

F

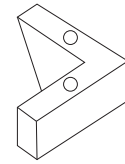

x 4

G

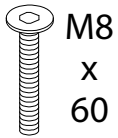

x 2

H

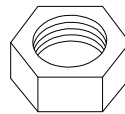

x 10

I

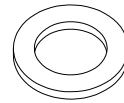

x 10

J

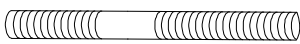

x 1

K

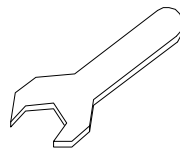

x 1

L

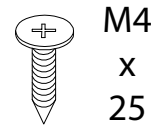

x 1

M

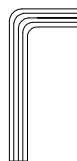

x 1

1

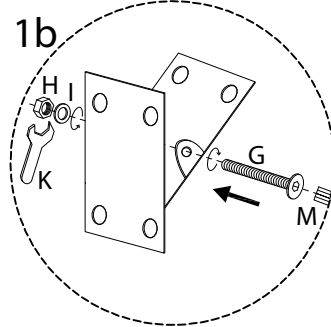
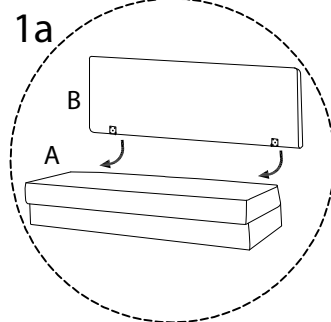
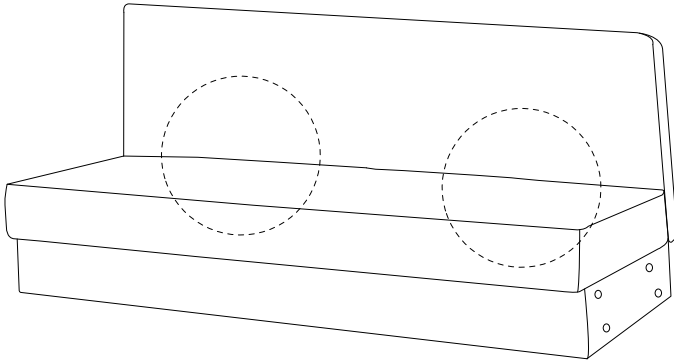
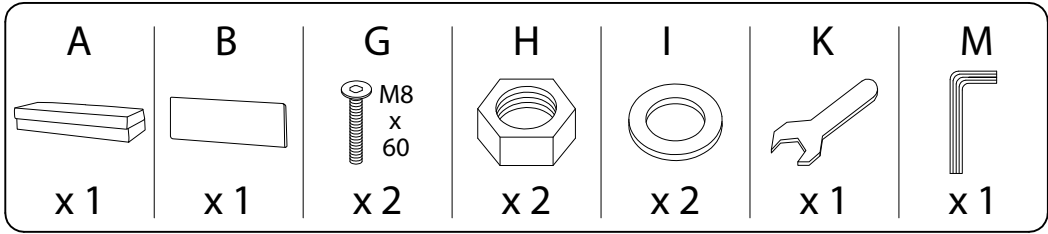

2

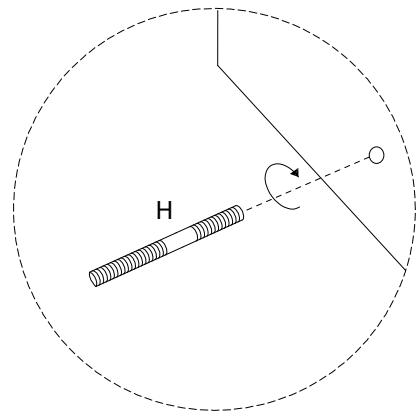
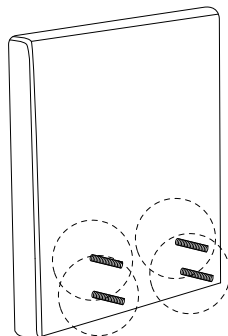
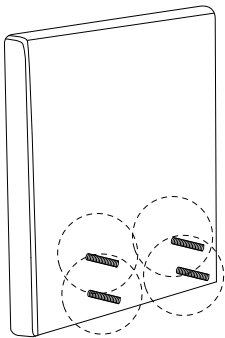
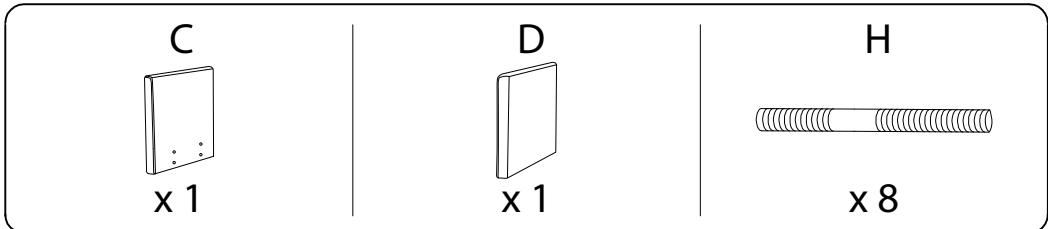

3

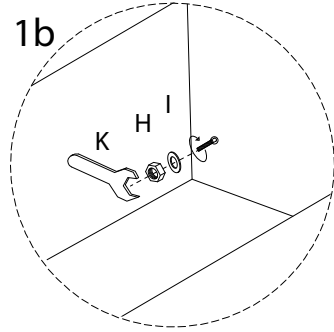
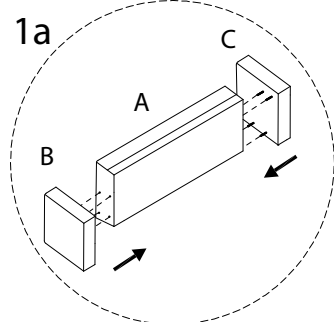
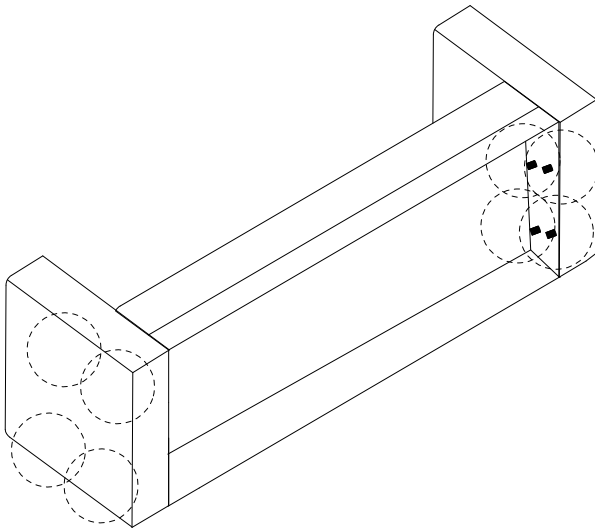
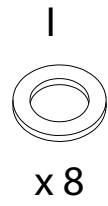
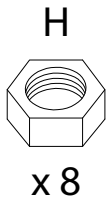

4

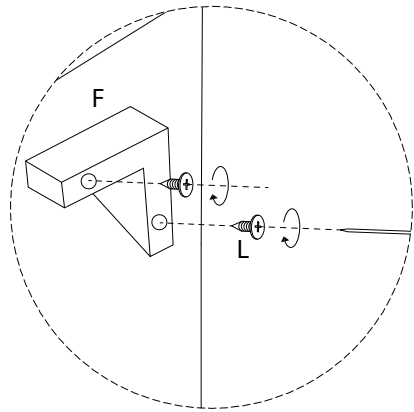
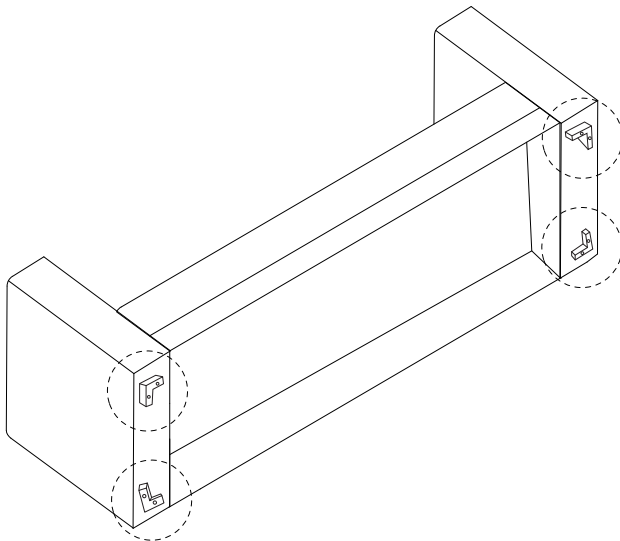
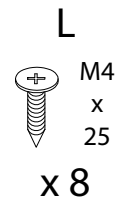
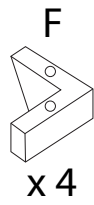

5

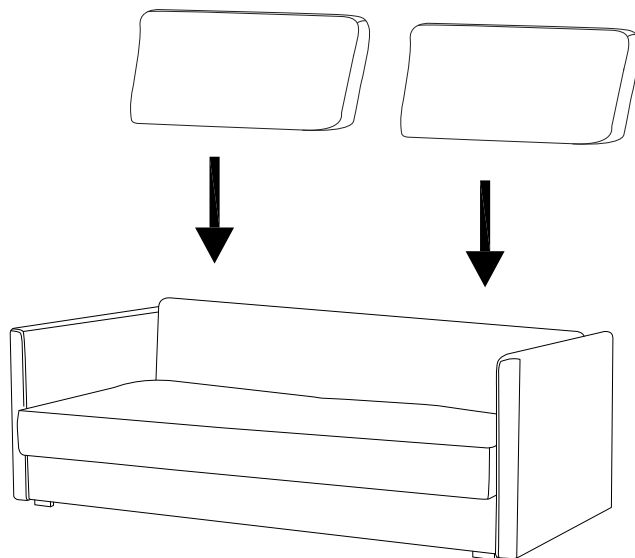

!

