

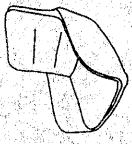

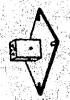





1		1
2		1
3		1
4		4
A	 M6x10	4
B	 M6x16	6
C	 M6x12	4
D	 M6x20	2
E	 $\phi 16 \times 1.2$	12
F	 4#	1

step 1

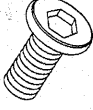

step 2

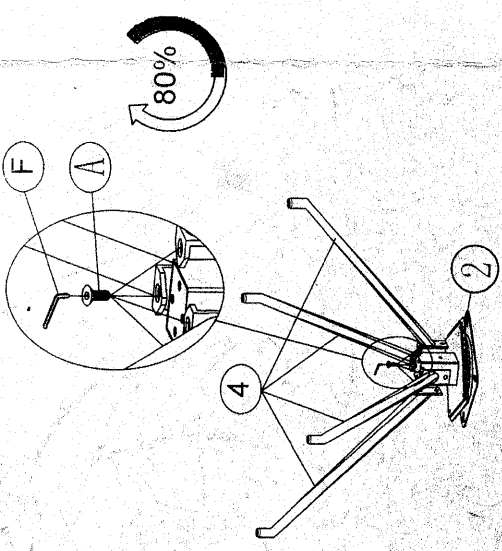
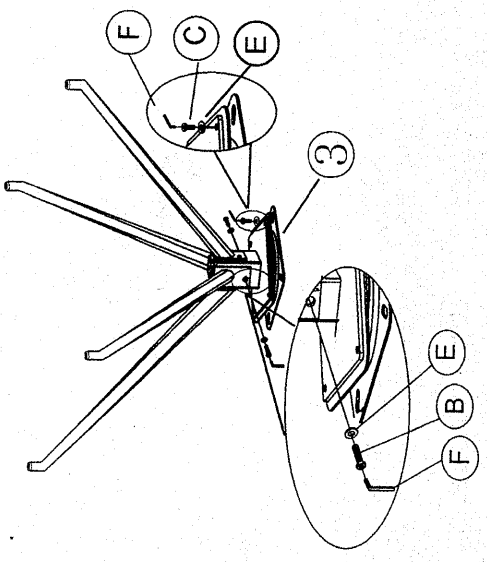

step 3

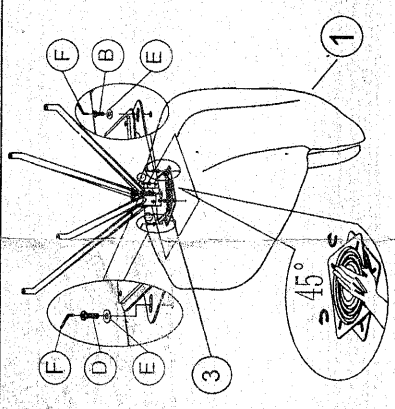

step 4

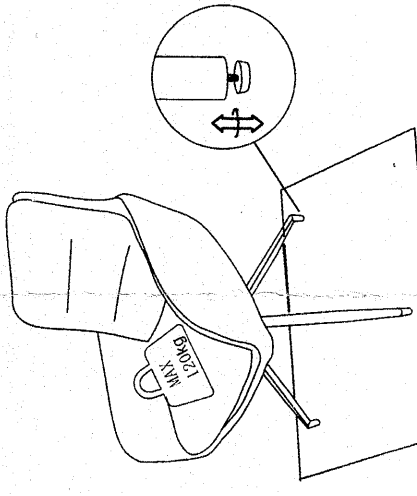

Item NO.: 89655 89656  
89657 89658