

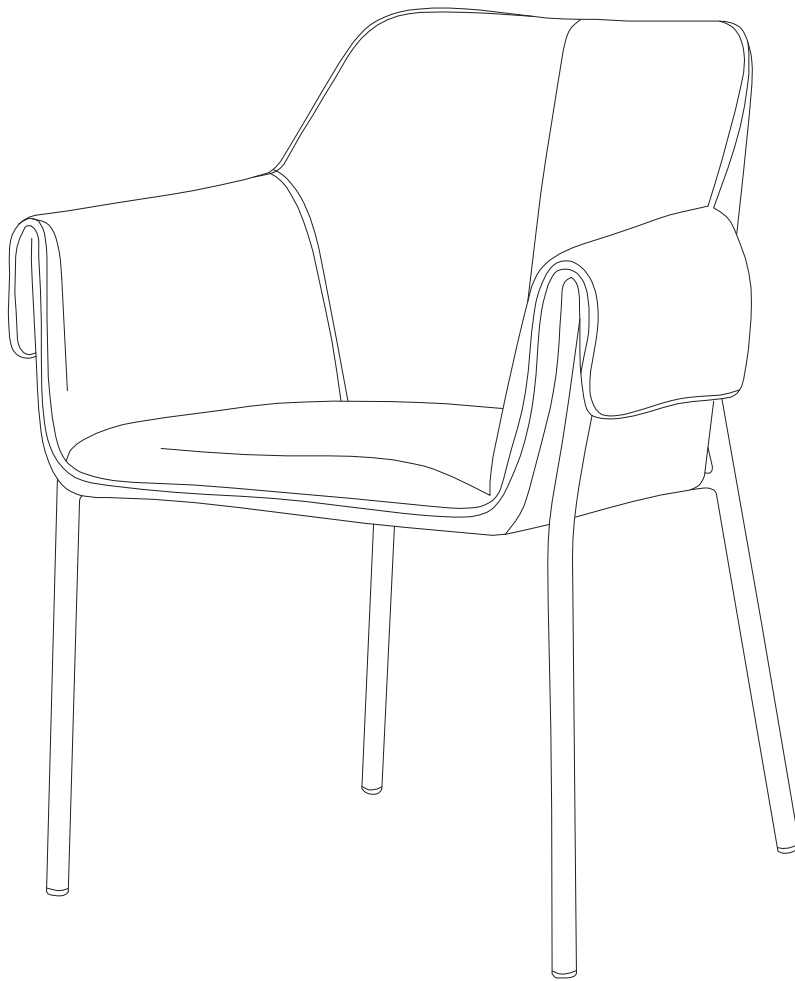

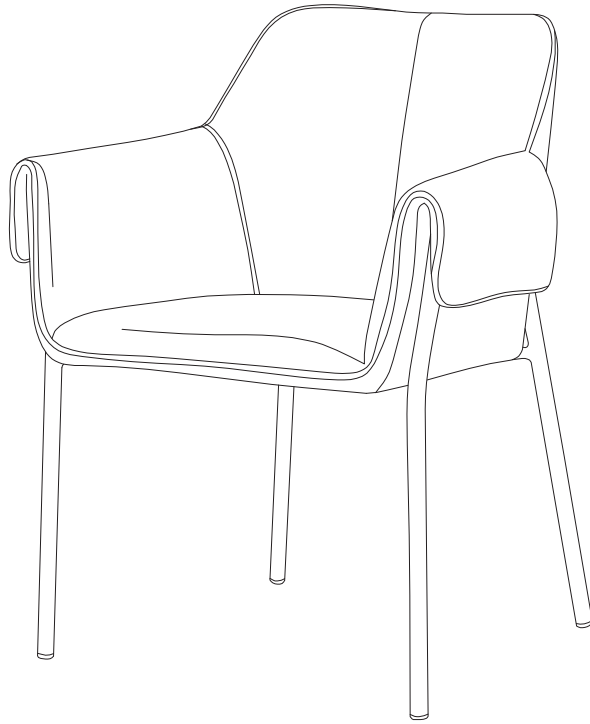

ARLA

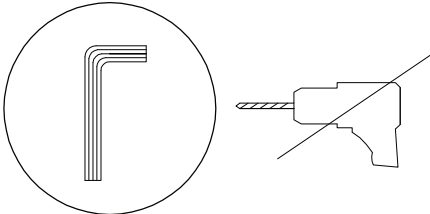

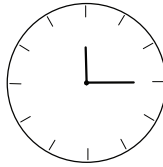
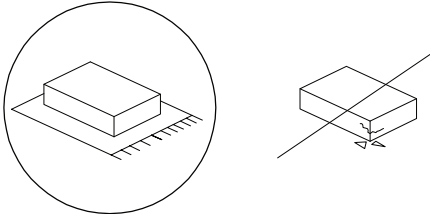

		
		15'
		
		2

1

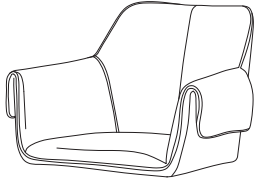

x 1

2



x 1

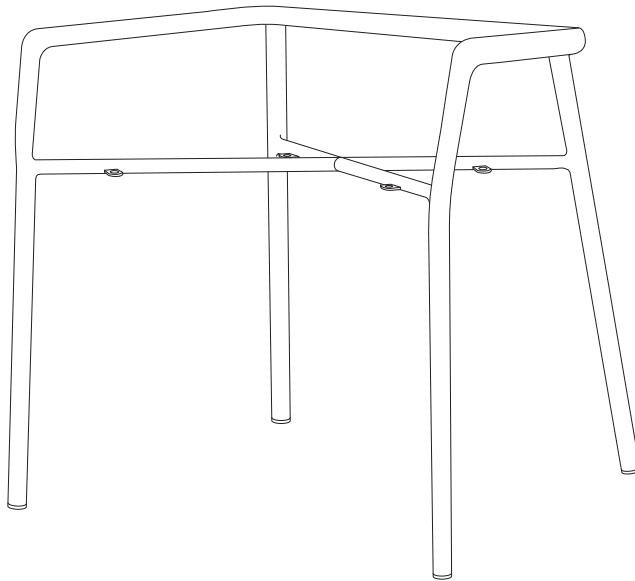
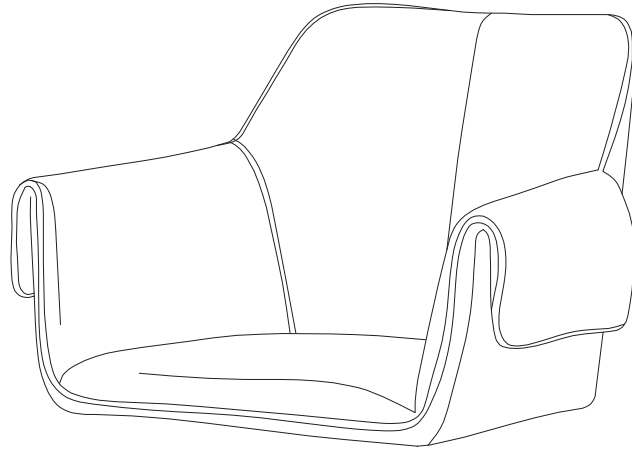

A



x 4

B

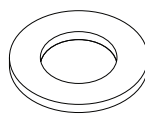

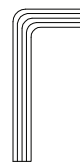

x 4

C



x 1

1

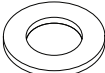
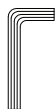
<p>1</p>  <p>x 1</p>	<p>2</p>  <p>x 1</p>	<p>A</p>  <p>M6 x 20</p> <p>x 4</p>	<p>B</p>  <p>x 4</p>	<p>C</p>  <p>x 1</p>
---	---	--	---	---

