

ERST-HOLZ®

WWW.ERST-HOLZ.DE

Artikel-Nr.: 60.77-08/180

Datum: 21.03.2024

Seite 01 von 05

Montageanleitung

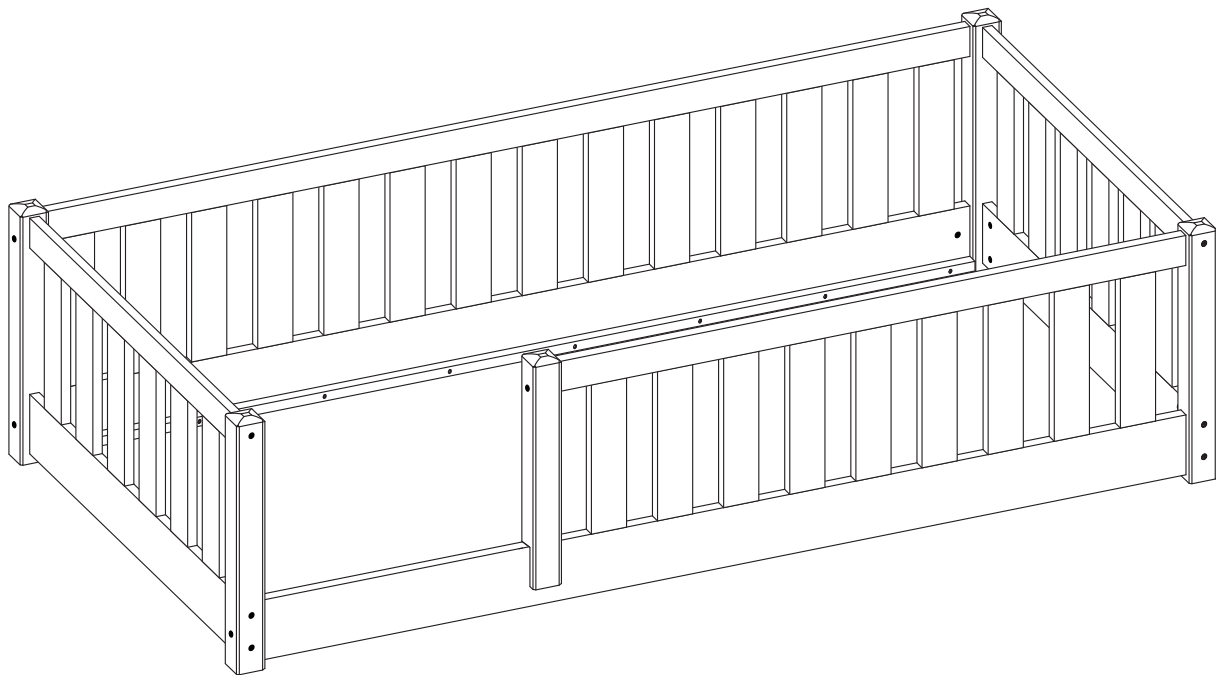

ERST-HOLZ® - die Marke für gute Holzprodukte

Steinhaus Handelsgesellschaft mbH & Co KG - Schauerödstr. 21 - 94152 Neuhaus - Tel.: 0 8503 924540

E-Mail: auftrag@erst-holz.de

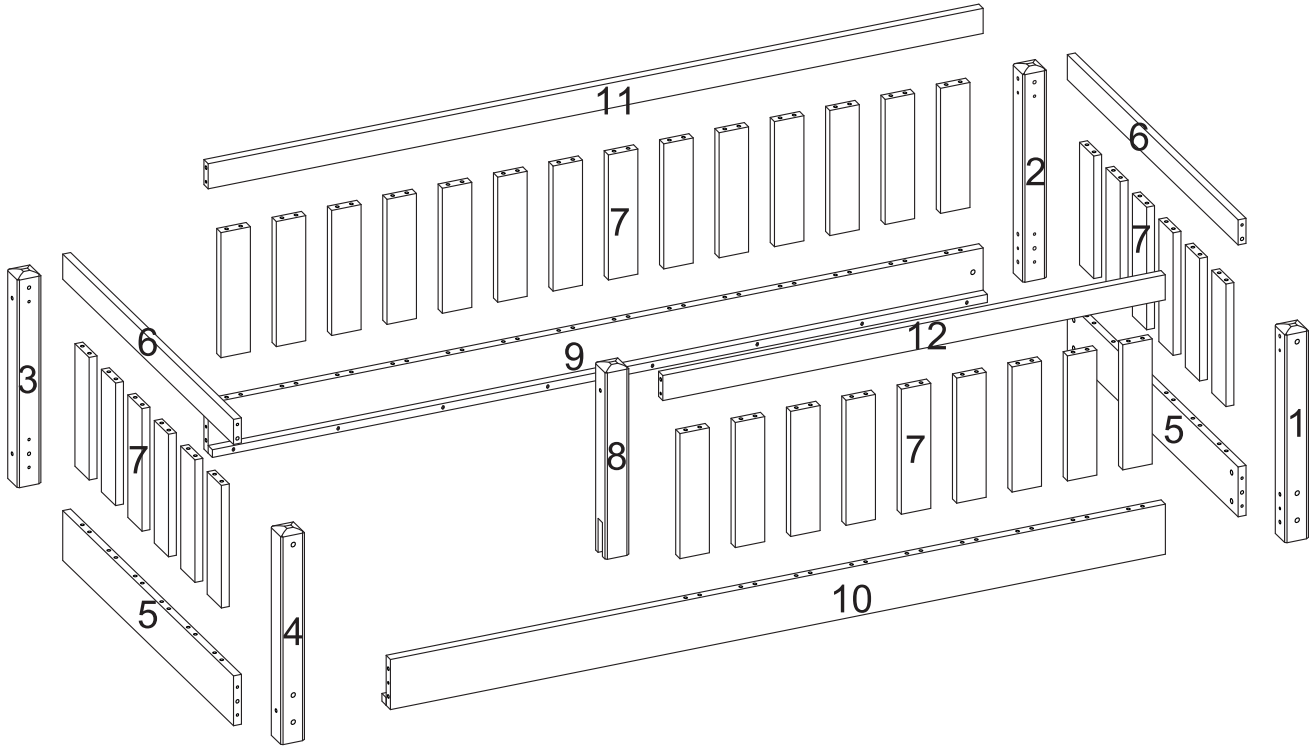





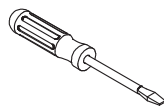
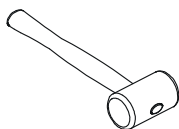
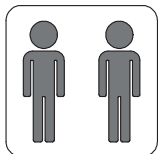

Achtung!

Bevor Sie die Schrauben, Dübel, Muttern in die dafür vorgesehenen Löcher stecken, prüfen Sie, ob sich gegebenenfalls noch Holzspäne in den Löchern befinden.

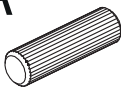
Sie benötigen zum Aufbau:

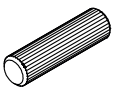

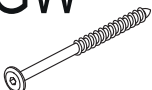
Teile-Nr.	Bezeichnung	Anzahl
1	Pfosten Kopfteil vorne	1
2	Pfosten Kopfteil hinten	1
3	Pfosten Fußteil hinten	1
4	Pfosten Fußteil vorne	1
5	Kopfteil-/Fußteilleiste unten	2
6	Kopfteil-/Fußteilleiste oben	2
7	Sprossen	35
8	kurzer Pfosten: Einstieg	1
9	Seitenteil hinten	1
10	Seitenteil vorne	1
11	Sicherungsleiste hinten	1
12	Sicherungsleiste vorne	1

A Ø10x40mm  20 Stück	E Ø10x13mm  12 Stück	K  1 Stück	P Ø8x40mm  140 Stück	BC Ø6x90mm  12 Stück	GW Ø6,3x90mm  8 Stück	IV Ø3x30mm  2 Stück
---	--	--	--	--	---	---

1

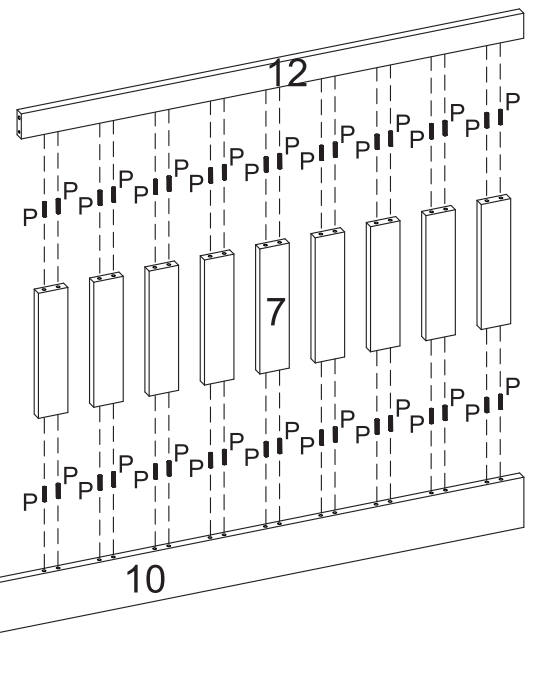
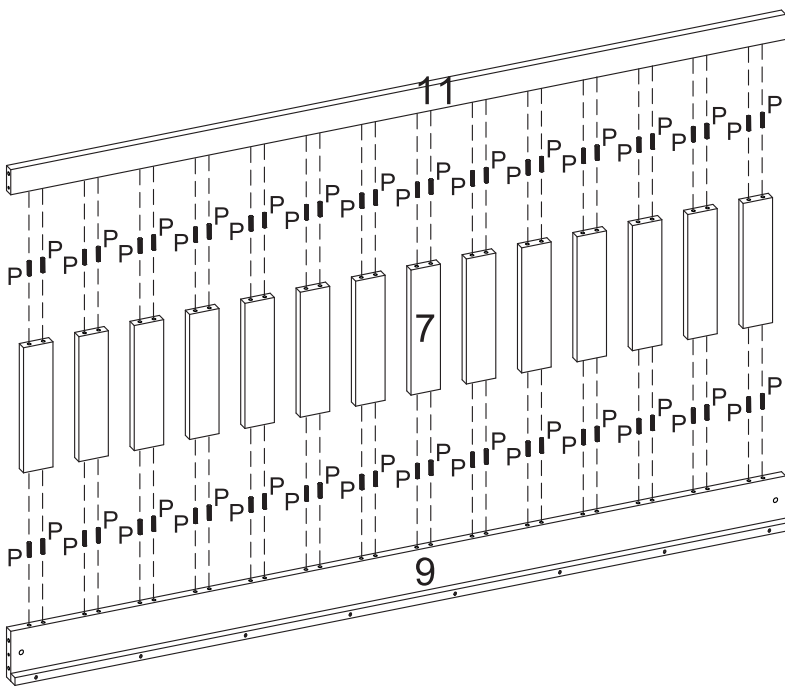
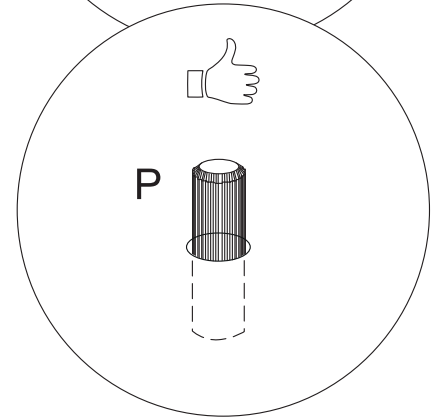
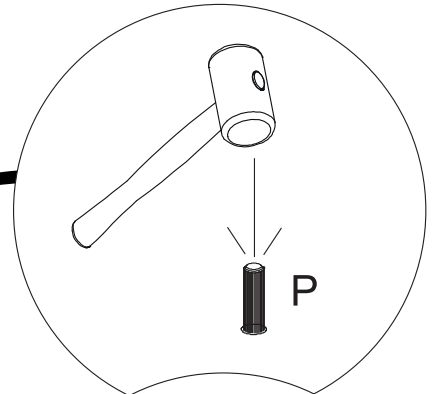
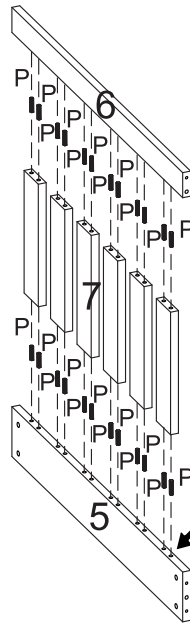
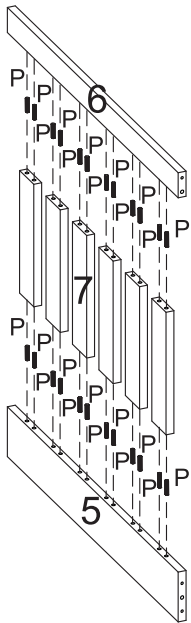

2

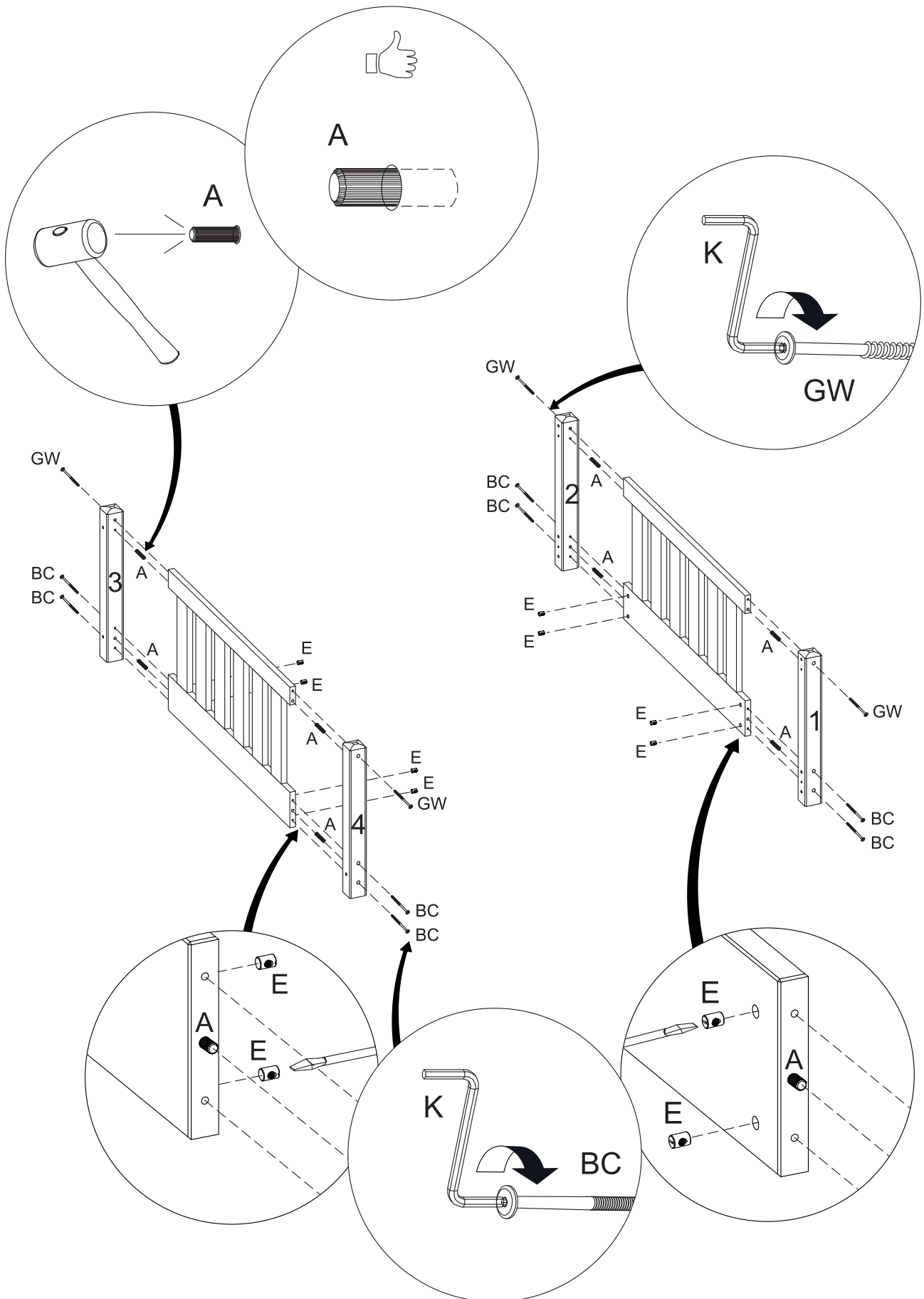

3

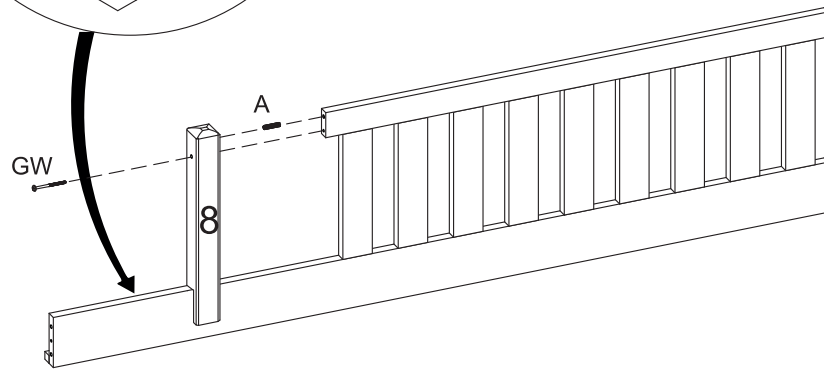
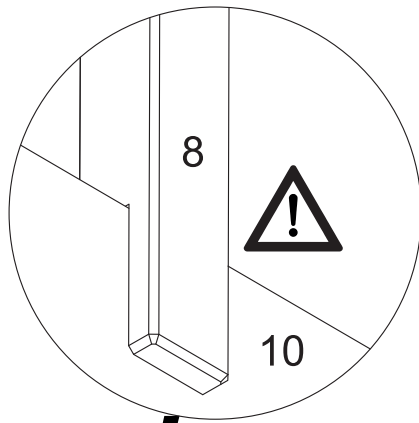

4

