









A		4*30	26
B		M6*40	18
C			2
D		Φ8*30	16
F		M6*60	6
G		M6*60	24
H			1



STEP:1

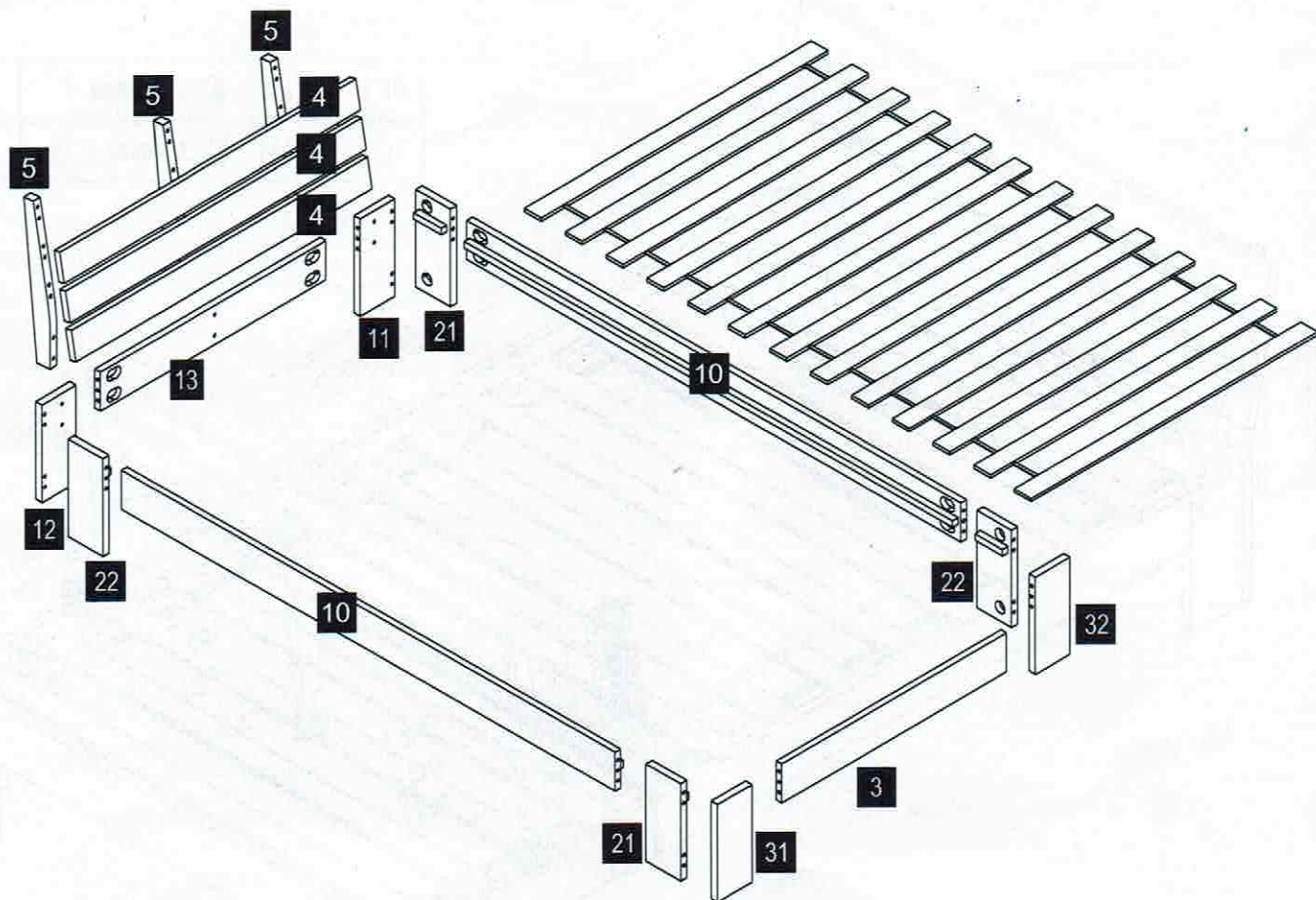
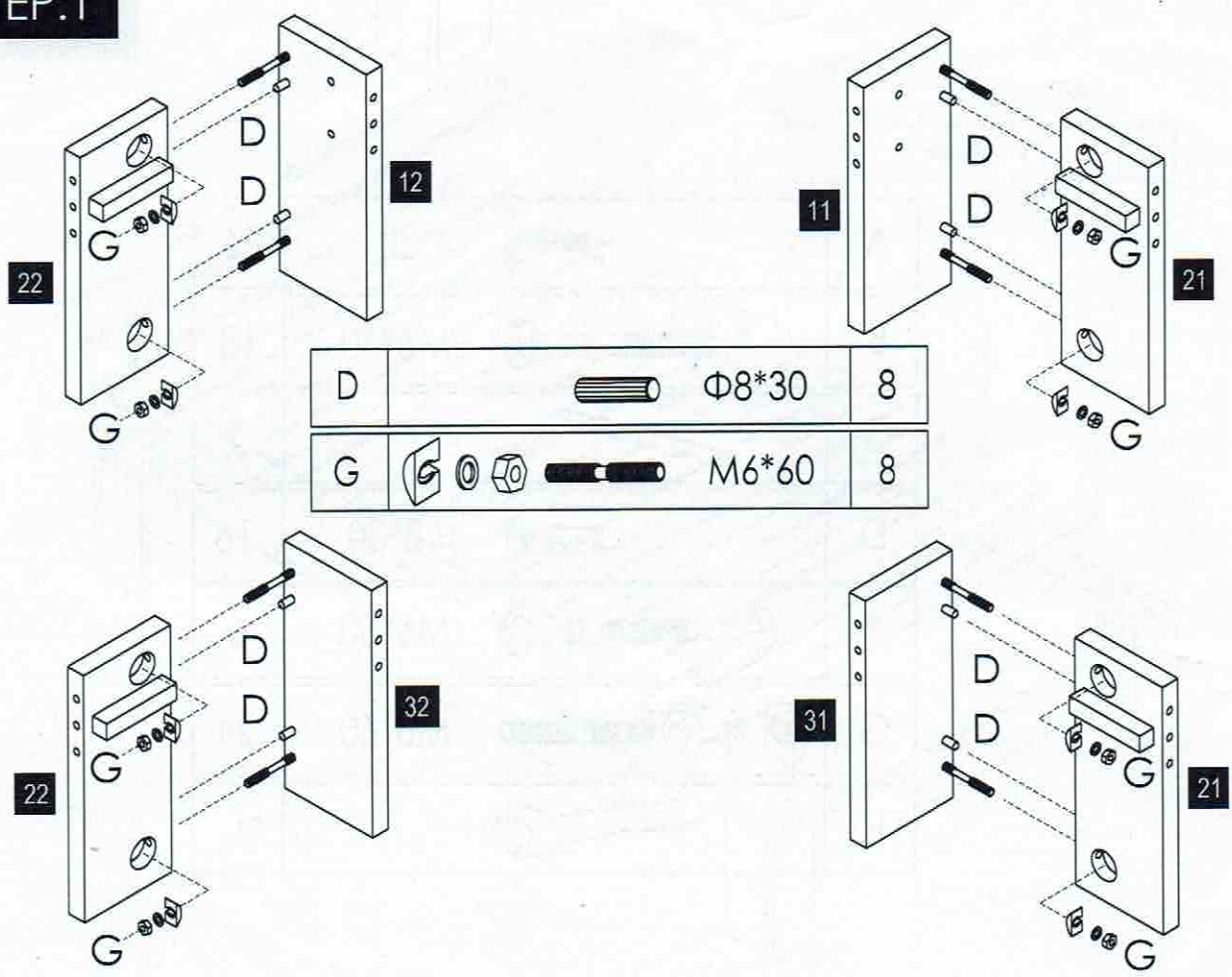

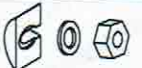

STEP:2

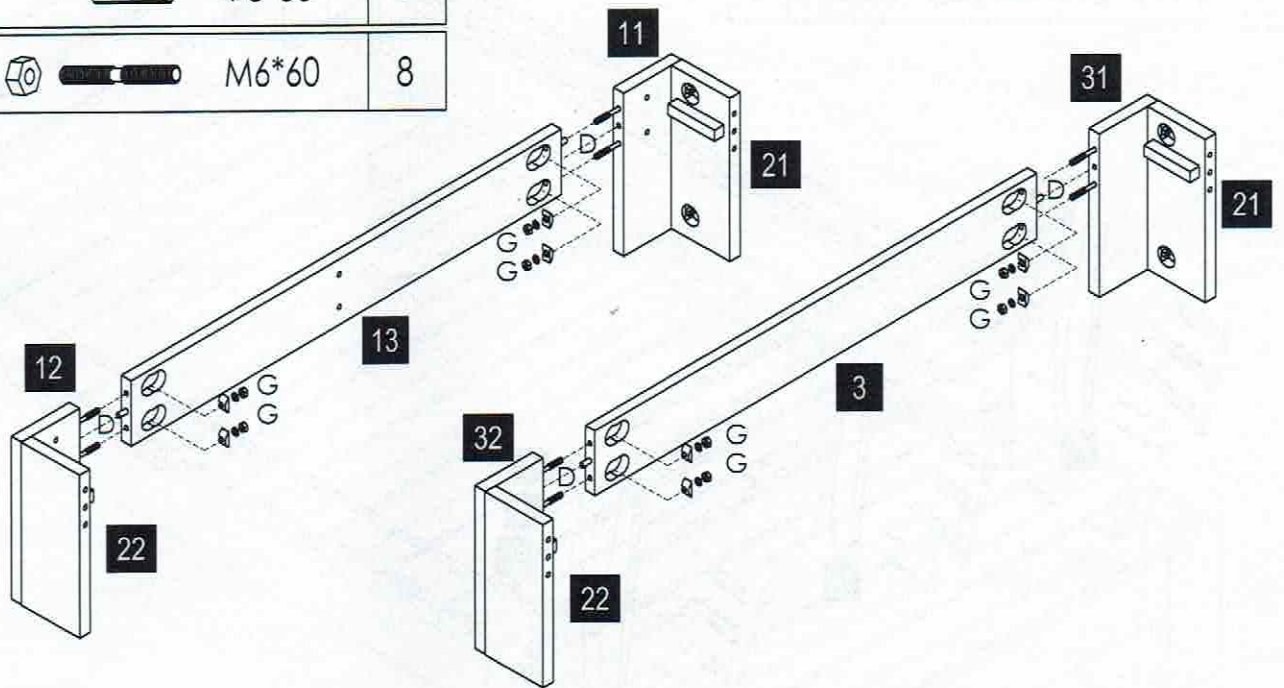
D		Φ8*30	4
G		M6*60	8



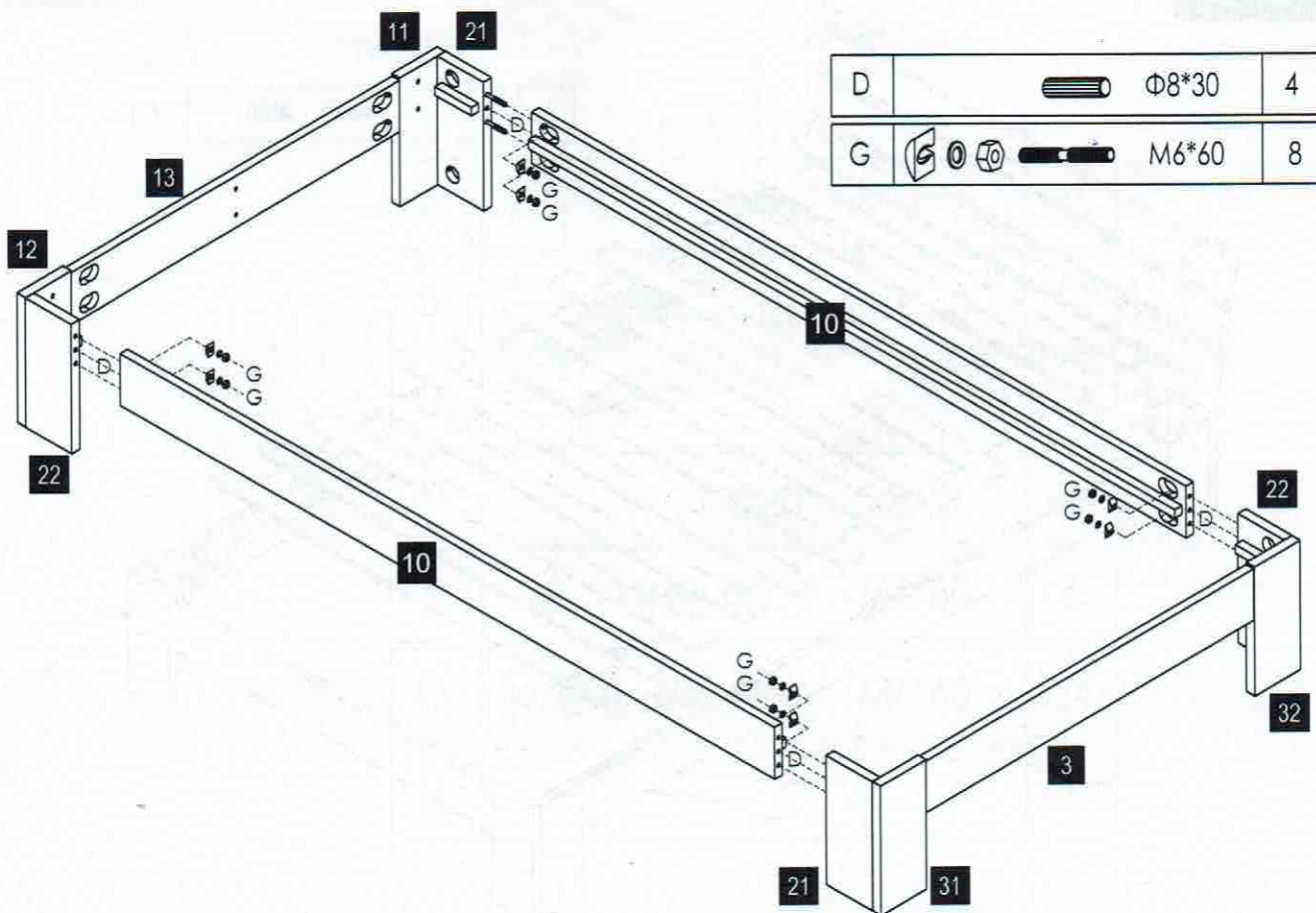

STEP:3

D		Φ8*30	4
G		M6*60	8



STEP:4

B		M6*40	18
F		M6*60	6

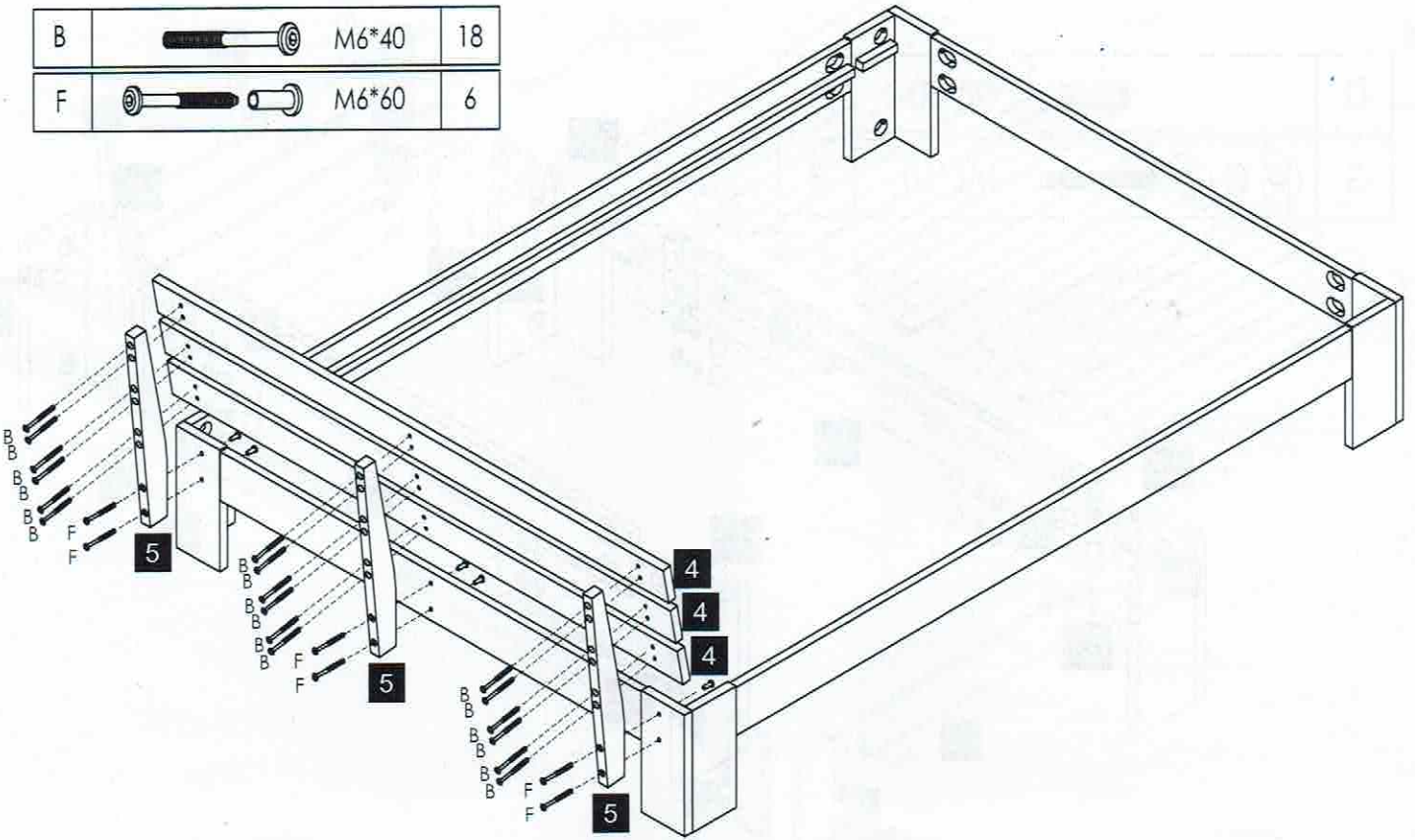

STEP:5

A		4*30	26
---	---	------	----

