

2794

How to install wall mounted furniture? Installation manual guide

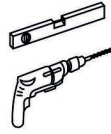

Bathroom furniture accessories

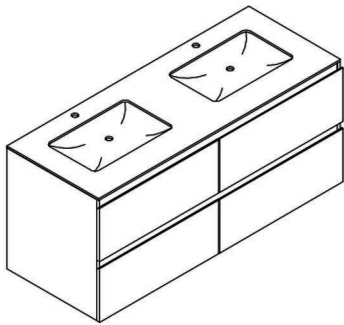

$\phi 20 \times 8 \text{mm} = 3$



$\phi 10 \text{mm} = 3$



$\phi 6 \times 70 \text{mm} = 3$

