

ASSEMBLY INSTRUCTION

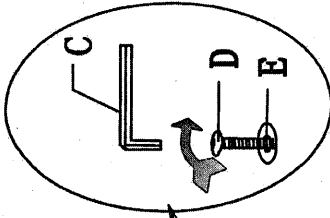

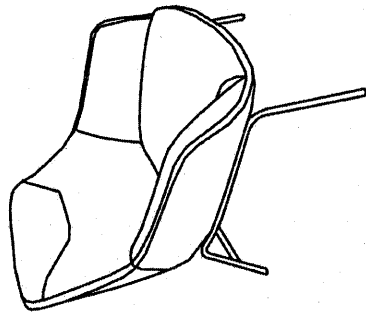

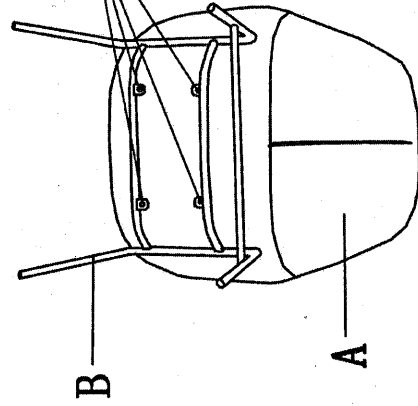

STEP 1:

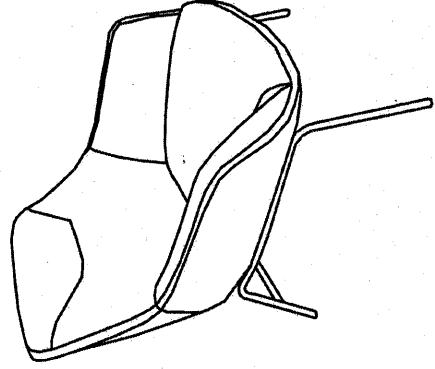

STEP 2:



ITEM	PART	NAME	QUANTITY
(A)		SEAT	1
(B)		LEGS	1
(C)		ALLEN KEY	1
(D)		BOLT	4
(E)		WASHER	4

NOTE:

PLEASE PUT THE CHAIR ONTO A SOFT AND CLEAN SURFACE FOR ASSEMBLY.