

# ASSEMBLY INSTRUCTION

**A**

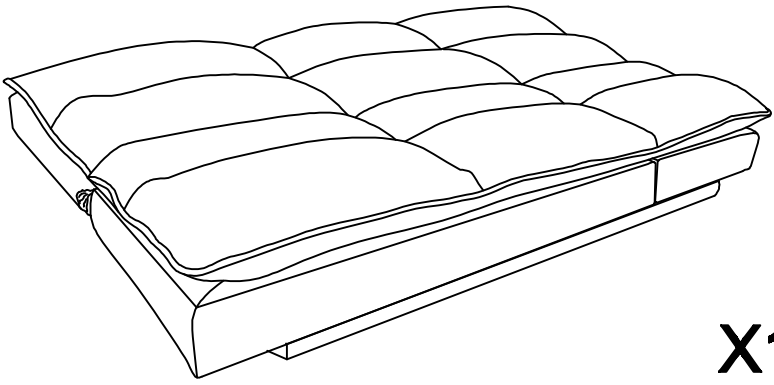

**X1**

**B**

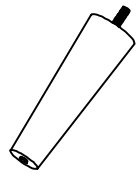

**X4**

**C**

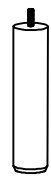

**X1**

**1**

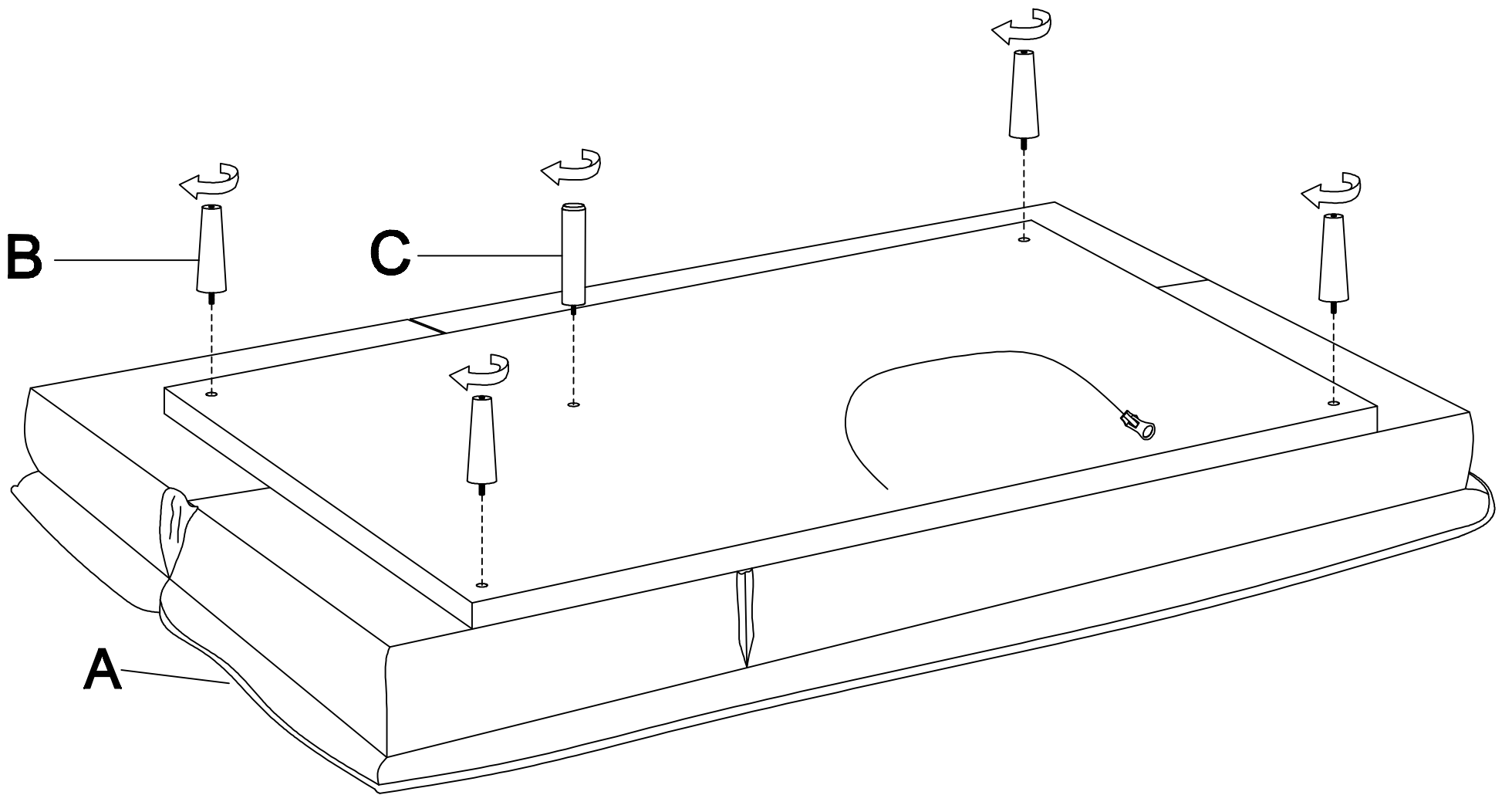

**2**

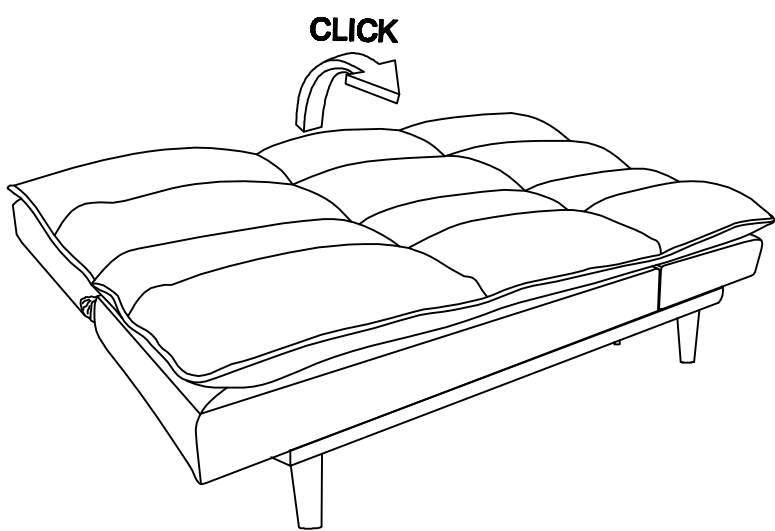

**3**

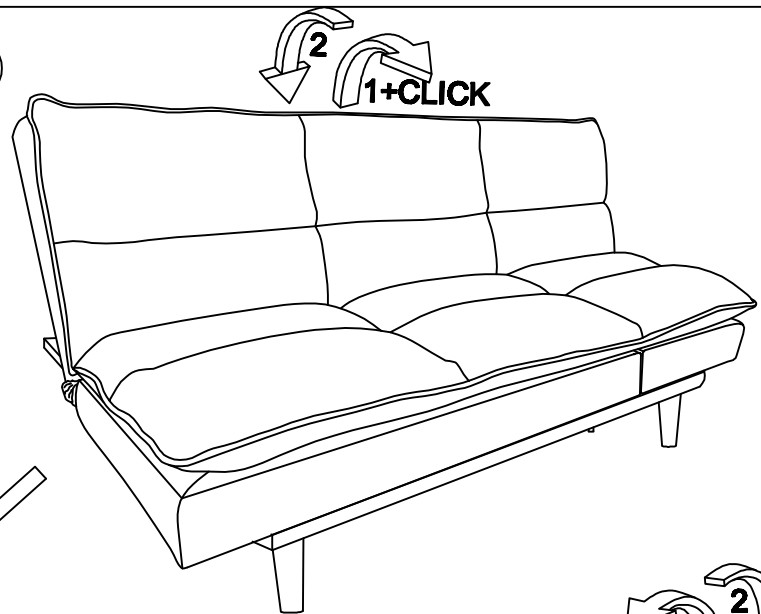

**4**

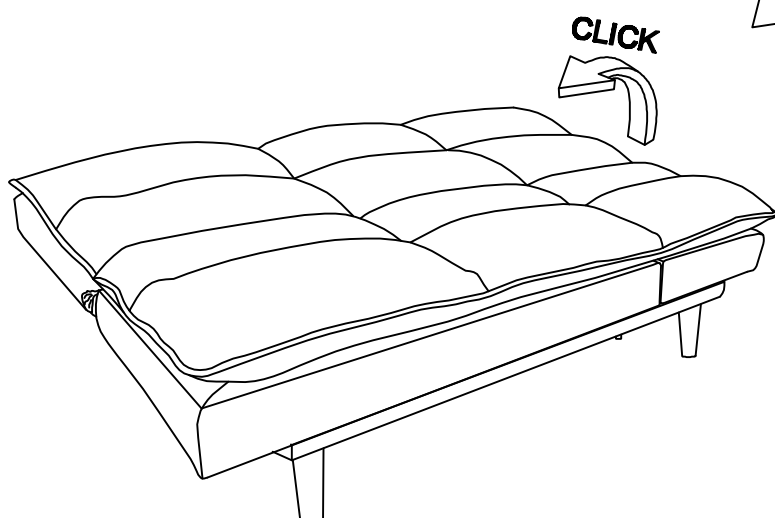

**5**

