

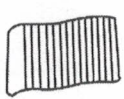

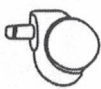





|               |   |        |   |
|---------------|---|--------|---|
| (1)X1         |    | (7)X5  |            |
| (2)X1         |    | (8)X4  | <br>6X20mm |
| (3)X1(L)X1(R) |    | (9)X6  | <br>6X25mm |
| (4)X1         |    | (10)X4 | <br>6X30mm |
| (5)X1         |   | (11)X1 |           |
| (6)X1         |  |        |   |

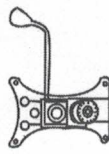
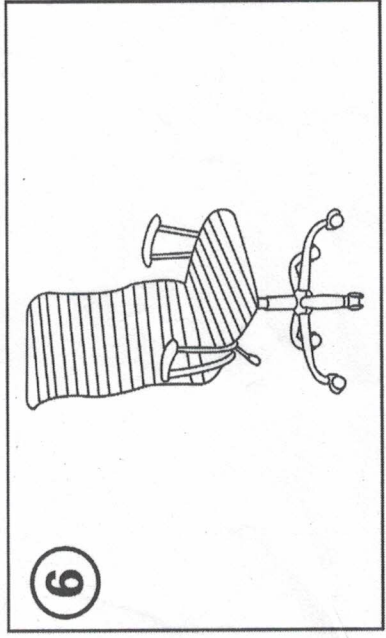
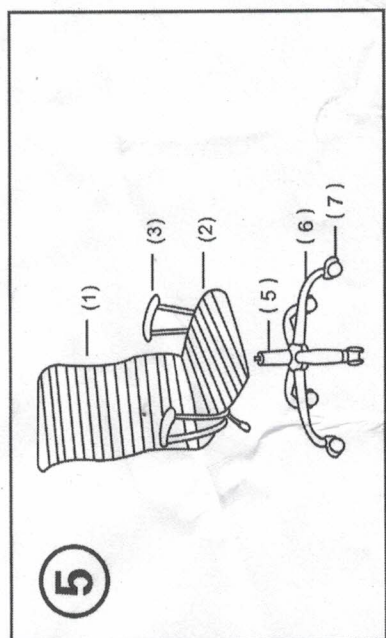
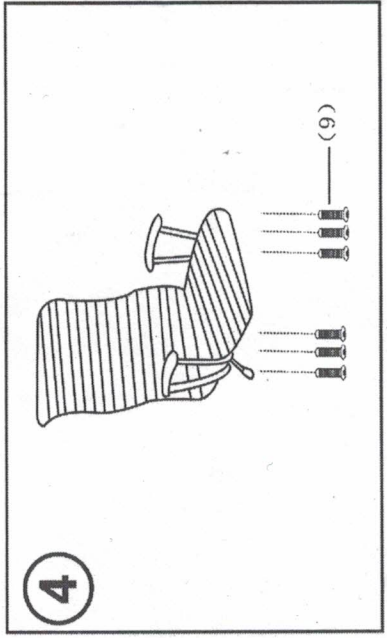
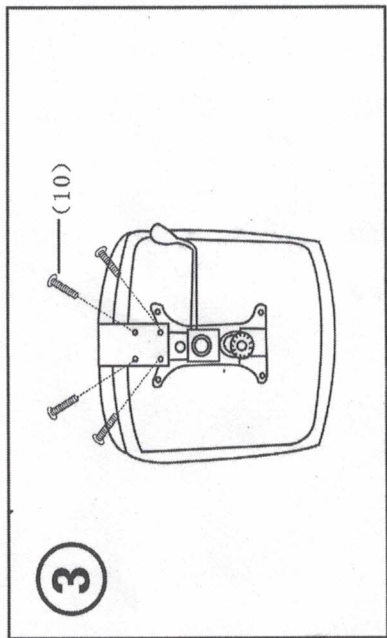
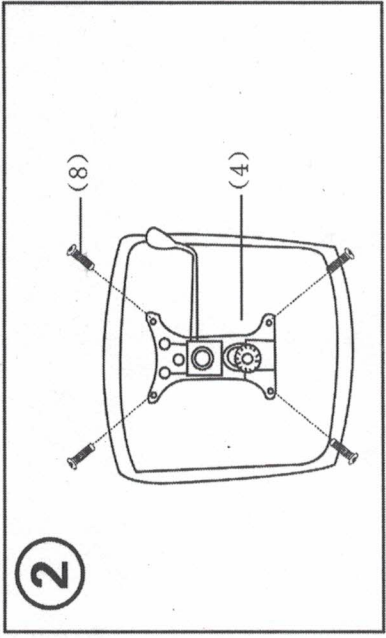
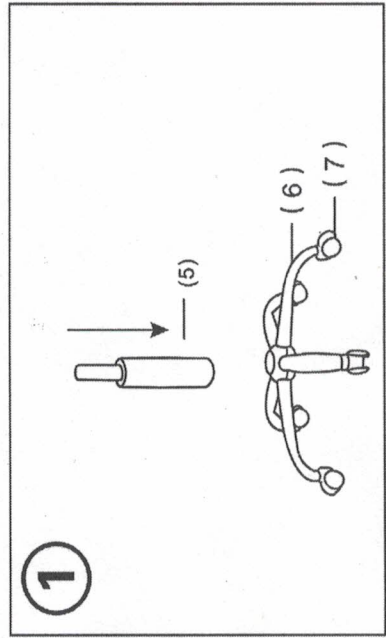

Das Montageset ist am Inneren des Karton befestigt!  
 The assembly set is attached to the inside of the carton!  
 Le kit de montage est fixé à l'intérieur du carton!  
 Il materiale per il montaggio è posizionato all'interno della scatola fissato con il nastro adesivo!  
 El material de montaje se coloca dentro de la caja fijado con cinta adhesiva!