

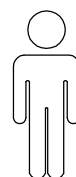

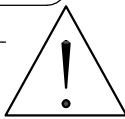

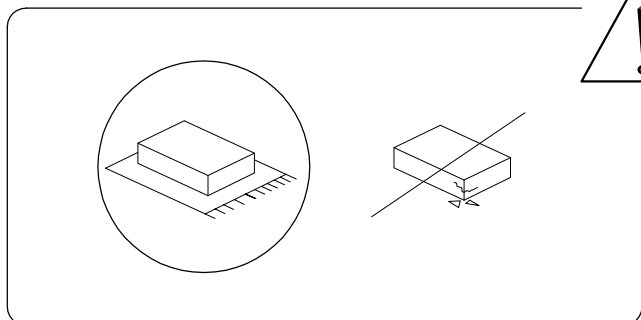

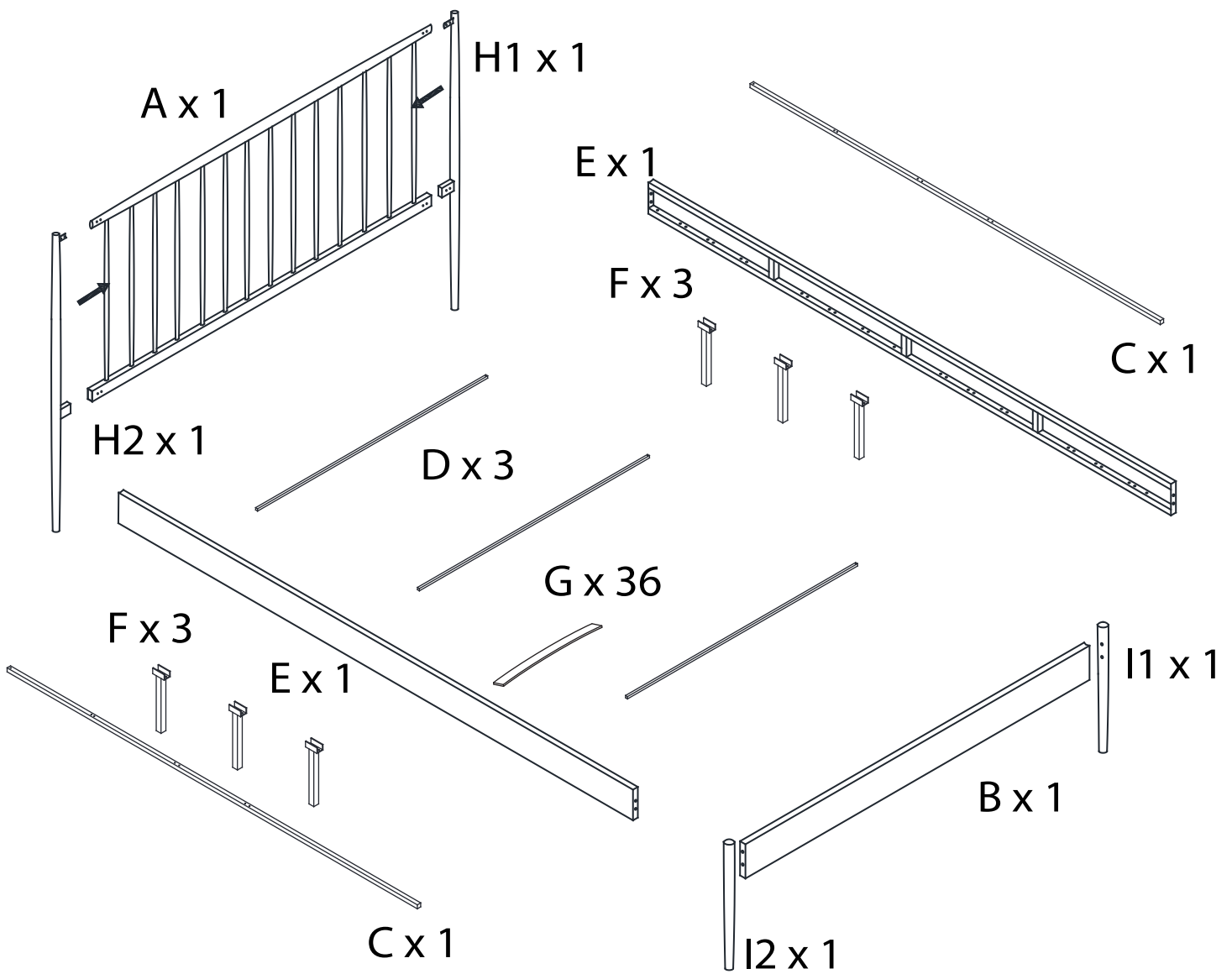

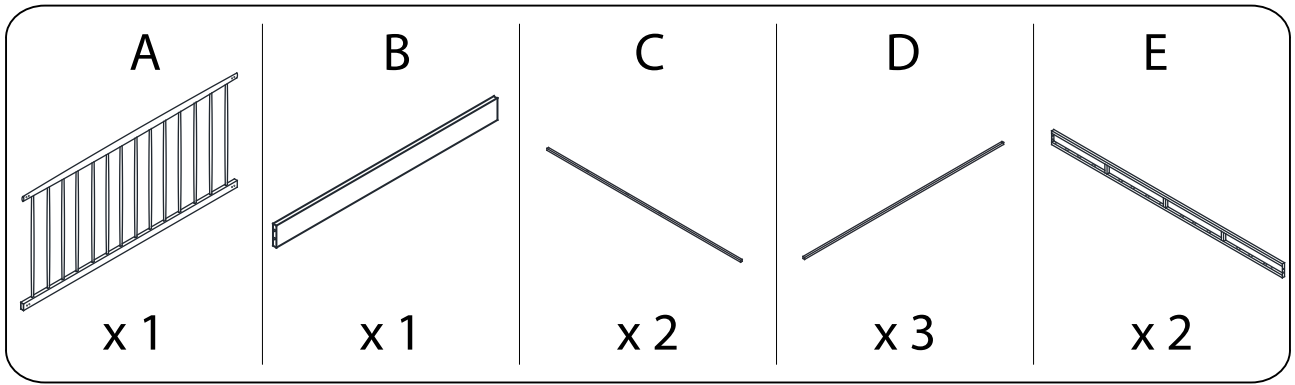
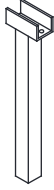
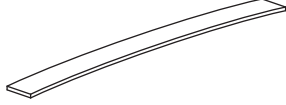

45'

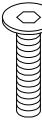

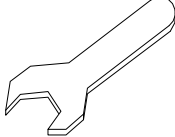
2

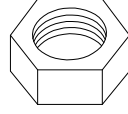
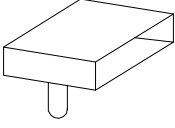
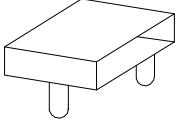

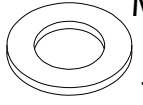
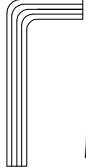
<p>F</p>  <p>x 6</p>	<p>G</p>  <p>x 36</p>	<p>H1/H2</p>  <p>x 2</p>	
<p>I1/I2</p>  <p>x 2</p>	<p>J</p>  <p>M6 x 55</p> <p>x 6</p>	<p>K</p>  <p>M6 x 50</p> <p>x 6</p>	
<p>L</p>  <p>M6 x 35</p> <p>x 10</p>	<p>M</p>  <p>M8 x 20</p> <p>x 20</p>	<p>N</p>  <p>x 1</p>	
<p>O</p>  <p>M4</p> <p>x 1</p>	<p>P</p>  <p>M6 x 18</p> <p>x 22</p>	<p>Q</p>  <p>x 24</p>	
<p>R</p>  <p>x 24</p>	<p>S</p>  <p>M8 x 22</p> <p>x 4</p>	<p>T</p>  <p>M6 x 18</p> <p>x 20</p>	<p>U</p>  <p>M5</p> <p>x 1</p>

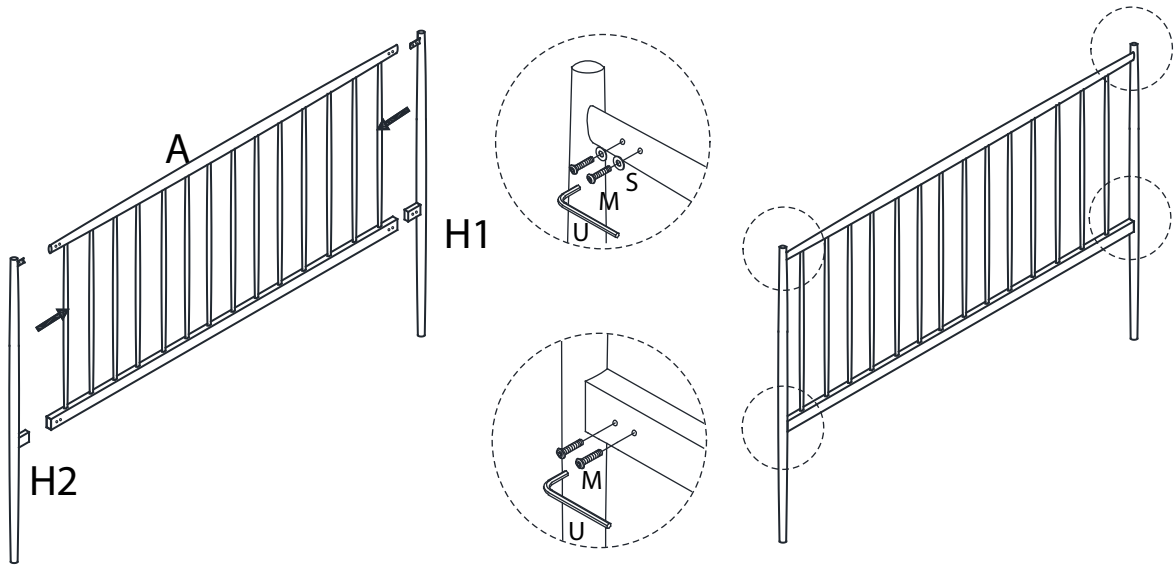
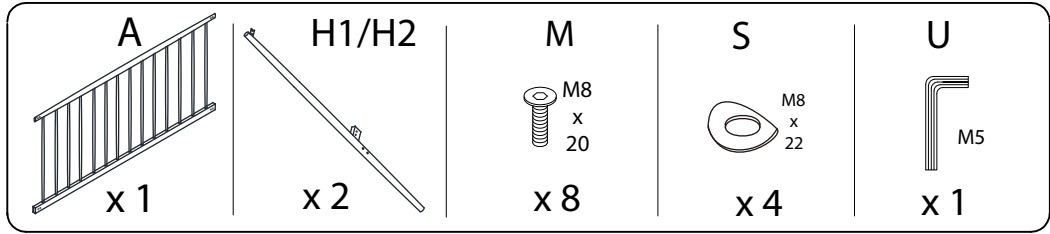

1

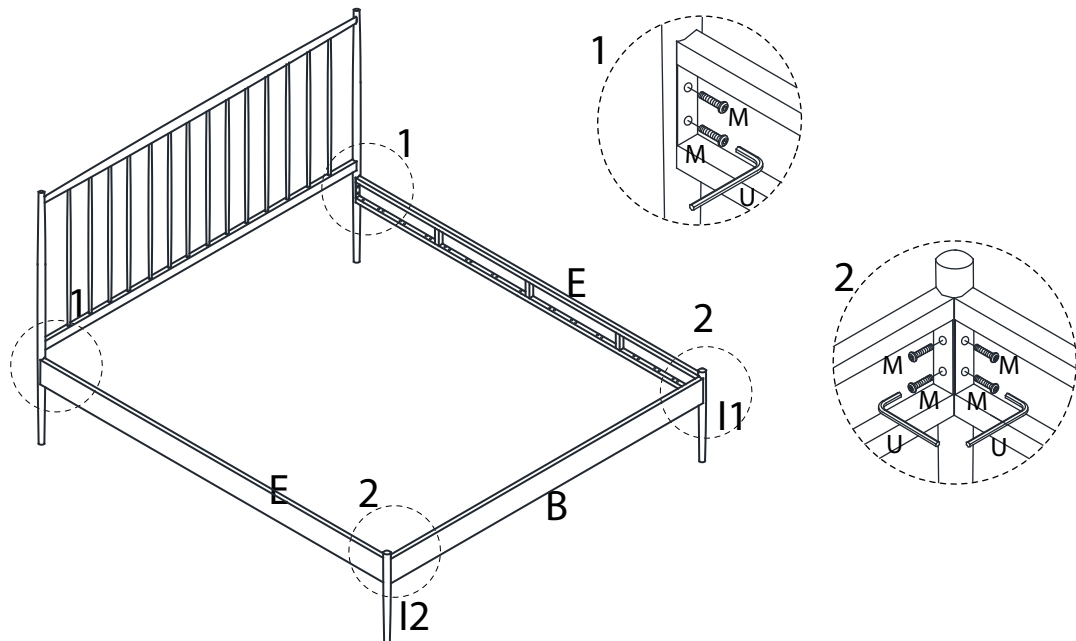
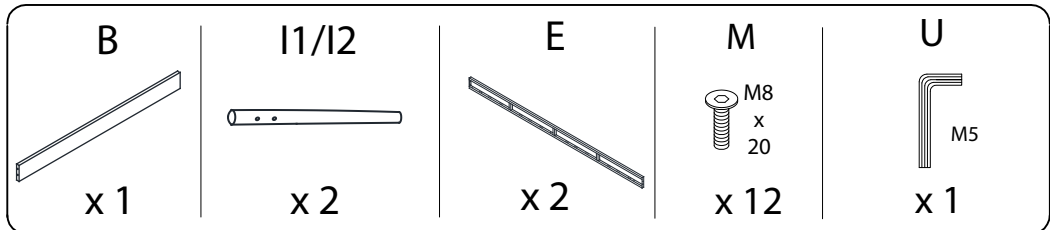

2





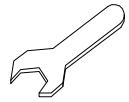
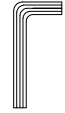
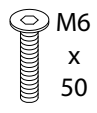

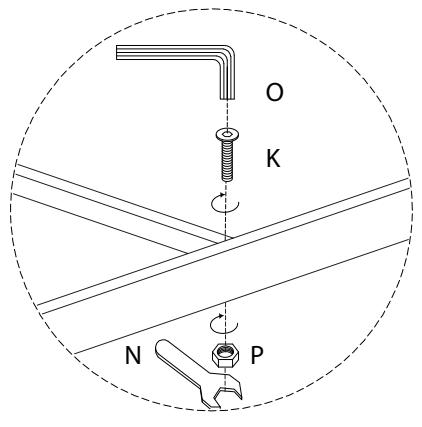
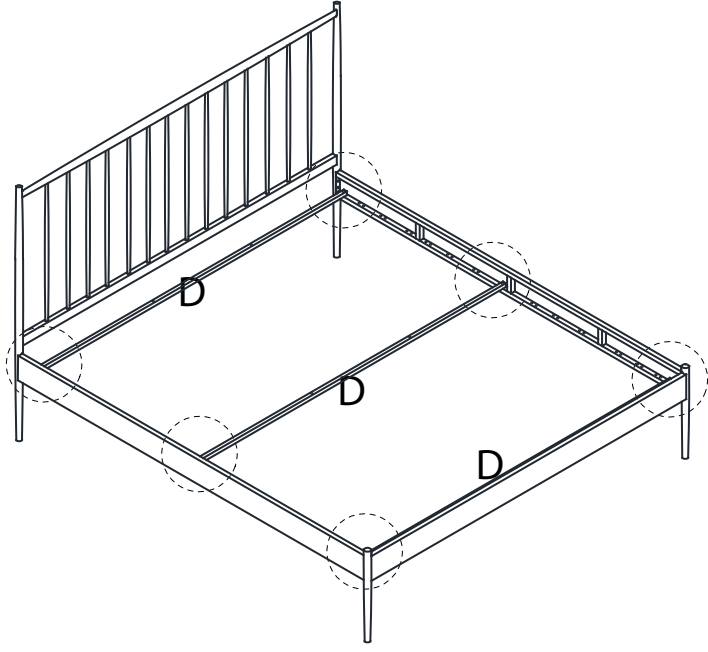
3

D	P	N	O	K
				
x3	x6	x1	x1	x6



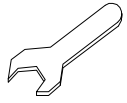

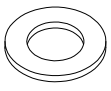
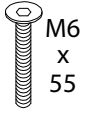
4

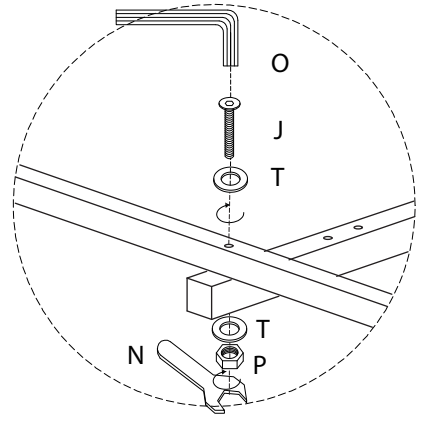
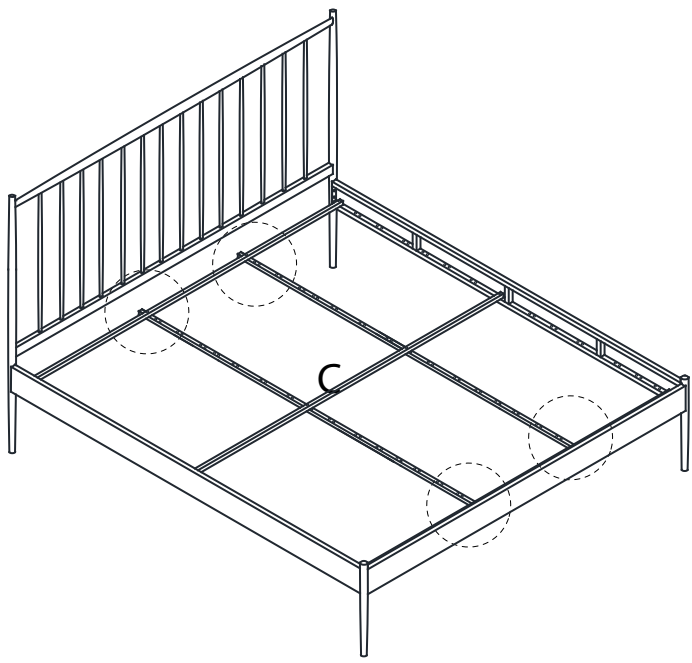
C	P	N	O	T	J
					
x2	x4	x1	x1	x8	x4



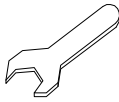
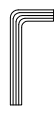
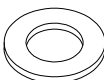
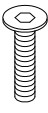
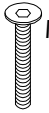

5

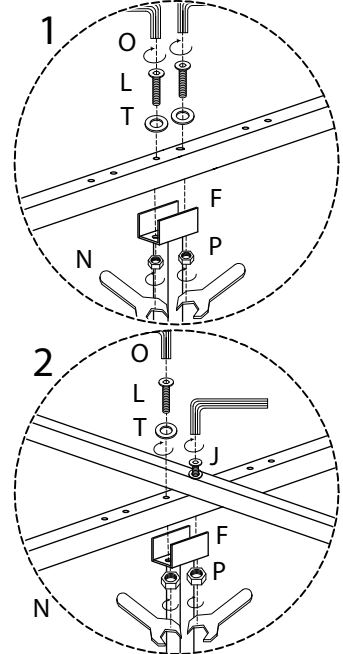
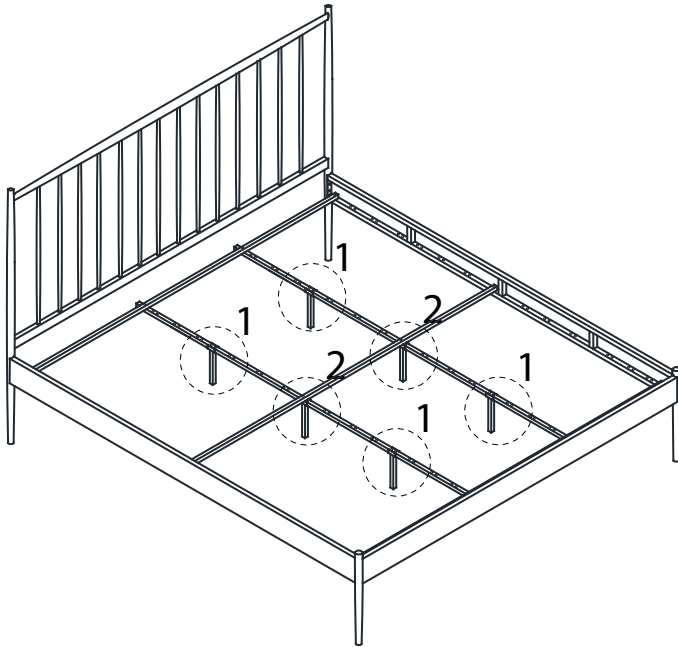
F  x 6	P  x 12	N  x 1	O  x 1	T  x 12	L  M6 x 35 x 10	J  M6 x 55 x 2
---	--	---	---	---	---	--

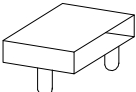

6

G  x 36	Q  x 24	R  x 24
--	--	--

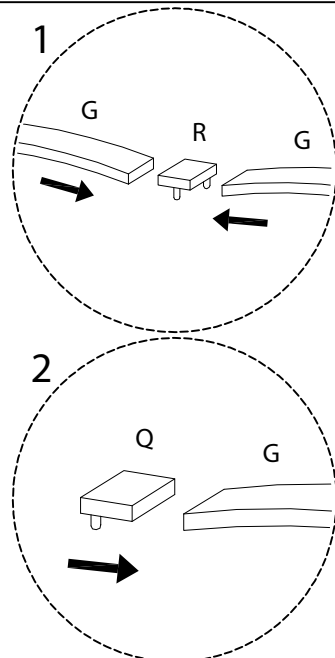
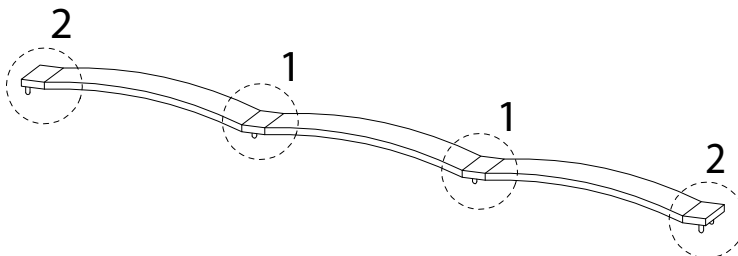

7

