

ROSALIE

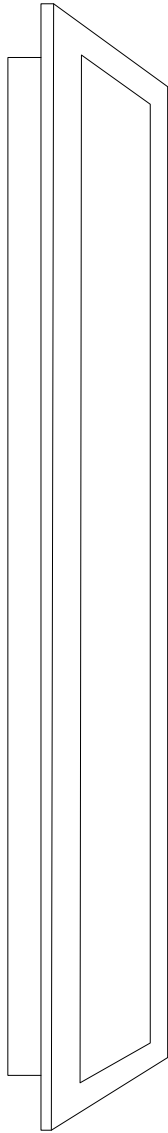

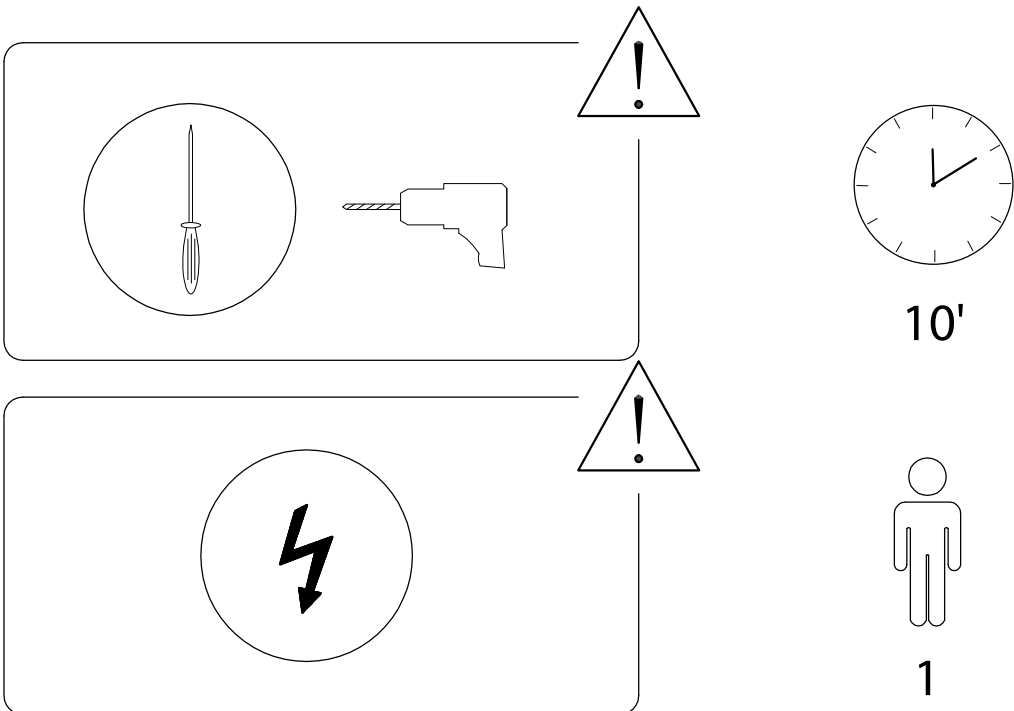

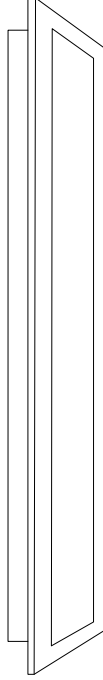
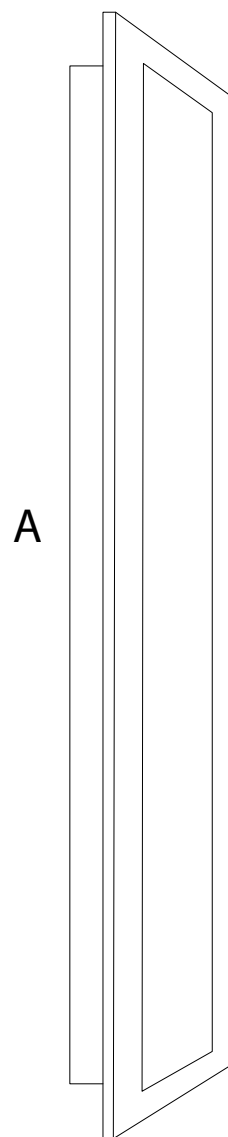

A

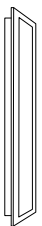

x 1

B

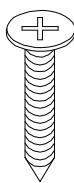

x 2

C



x 2

1

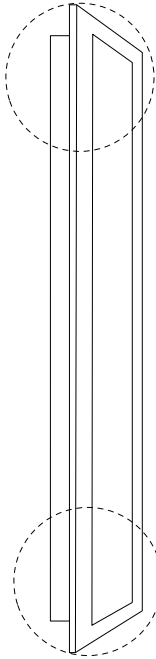
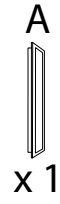

A

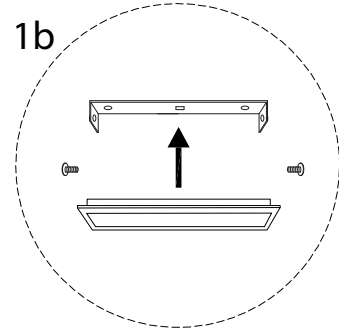
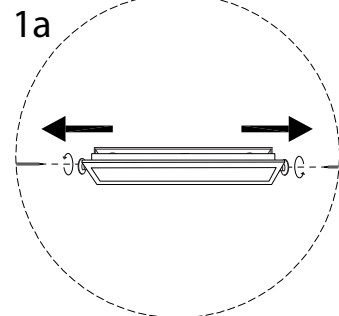
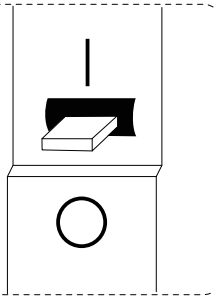

2

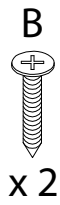

x 2

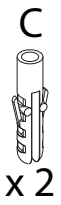

x 2

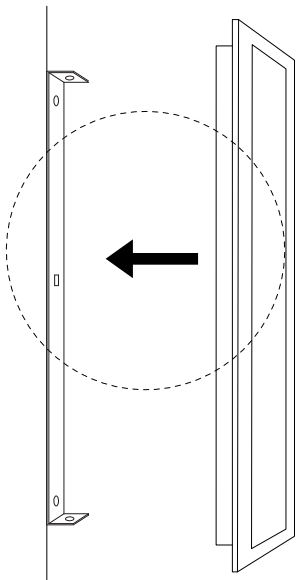

A

