

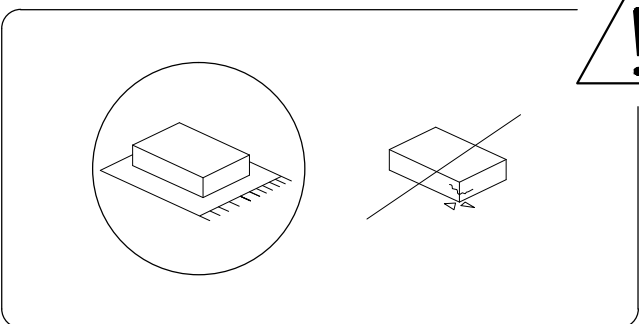

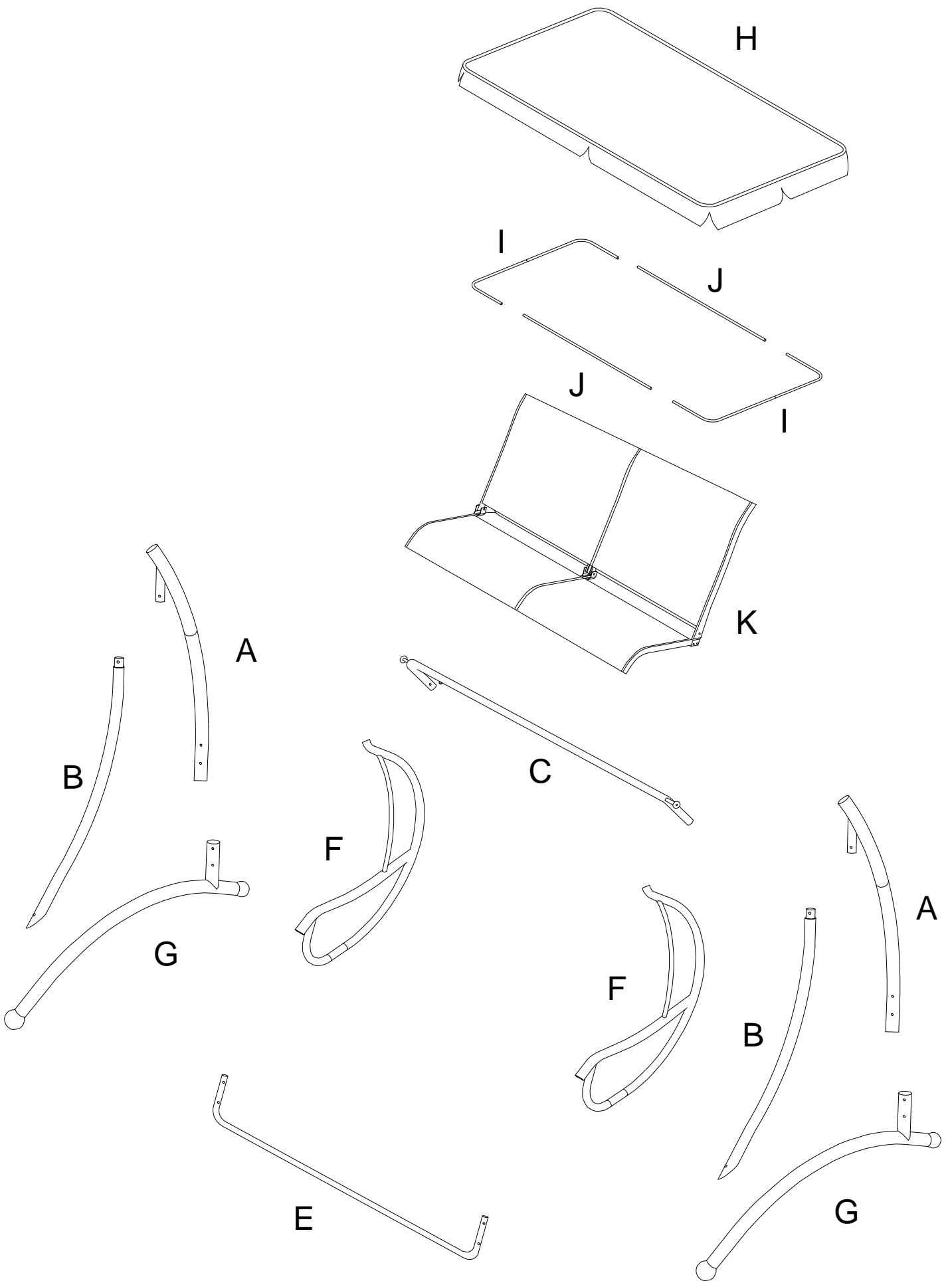

60'



2

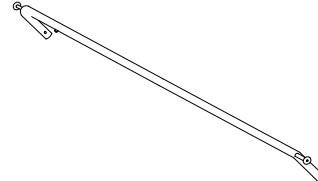
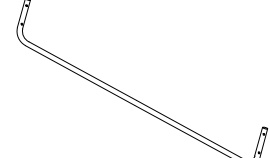

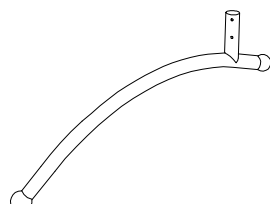
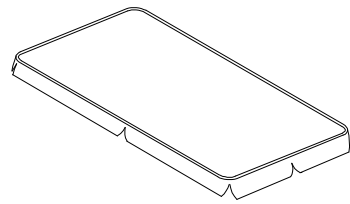
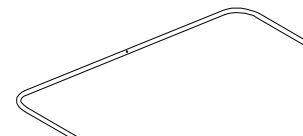
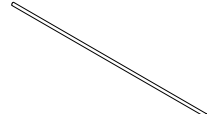
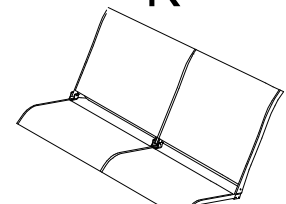
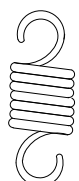
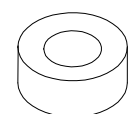
<p>A</p>  <p>x 2</p>	<p>B</p>  <p>x 2</p>	<p>C</p>  <p>x 1</p>
<p>E</p>  <p>x 1</p>	<p>F</p>  <p>x 2</p>	<p>G</p>  <p>x 2</p>
<p>H</p>  <p>x 1</p>	<p>I</p>  <p>x 2</p>	<p>J</p>  <p>x 2</p>
<p>K</p>  <p>x 1</p>	<p>M</p>  <p>x 2</p>	<p>O</p>  <p>x 4</p>

P2

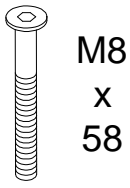

x 6

P3

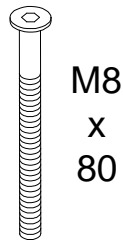

x 6

P4

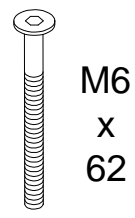

x 4

T

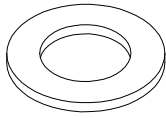

x 4

T1

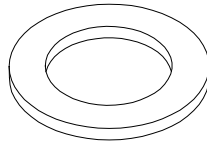

x 10

S1

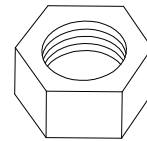

x 10

N1

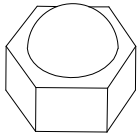

x 10

S

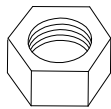

x 4

N

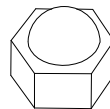

x 4

V



x 1

X

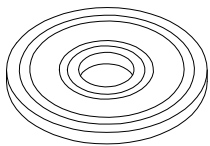

x 2

Y

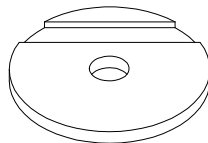

x 4

Z1







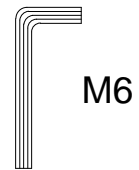



x 1

Z2



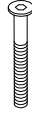
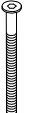



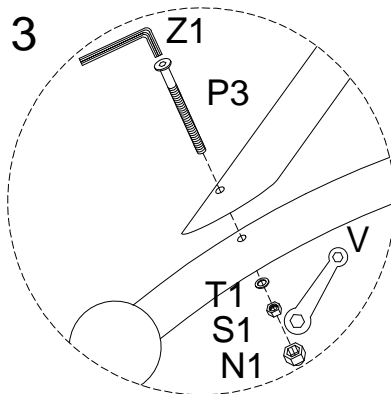
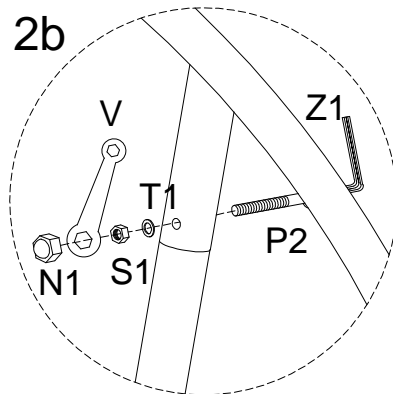
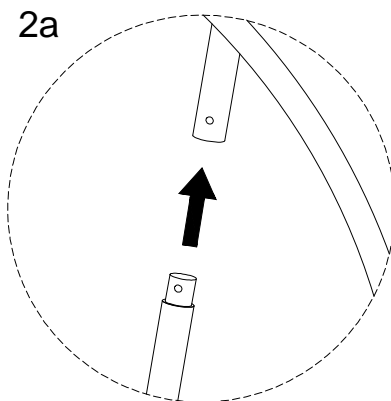
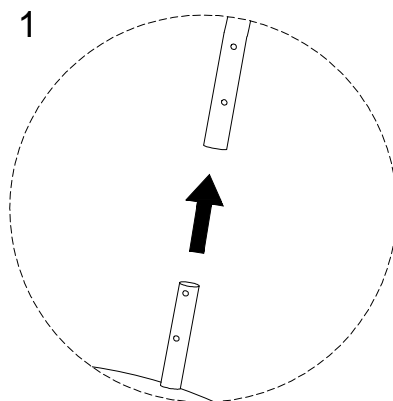
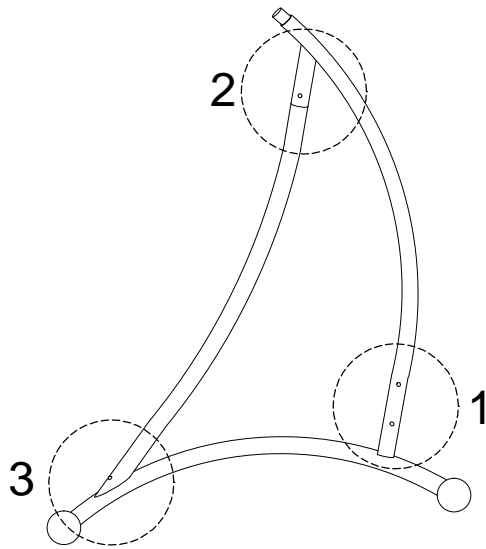

x 1

1 x 2

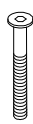
A  x 1	B  x 1	G  x 1	T1  x 2	P2  M8 x 58 x 1
P3  M8 x 80 x 1	S1  x 2	N1  x 2	V  x 1	Z1  M8 x 1







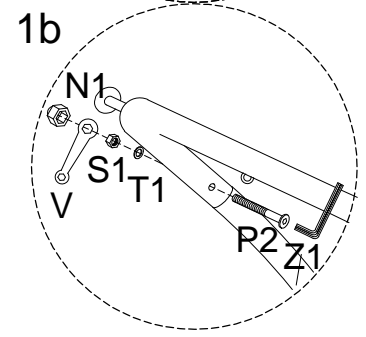
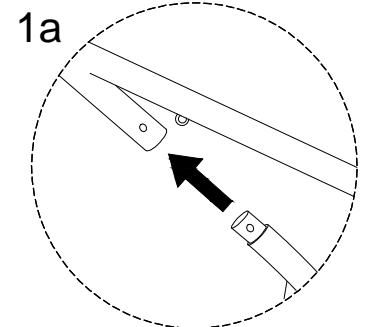
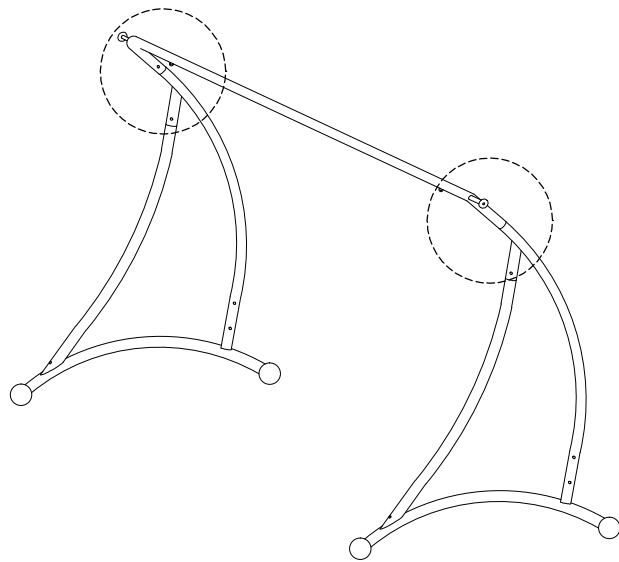

2

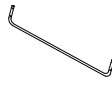
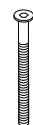
C	P2	T1	S1	N1	V	Z1
	 M8 x 58					 M8
x 1	x 2	x 2	x 2	x 2	x 1	x 1







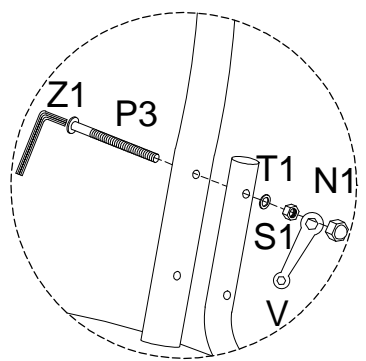
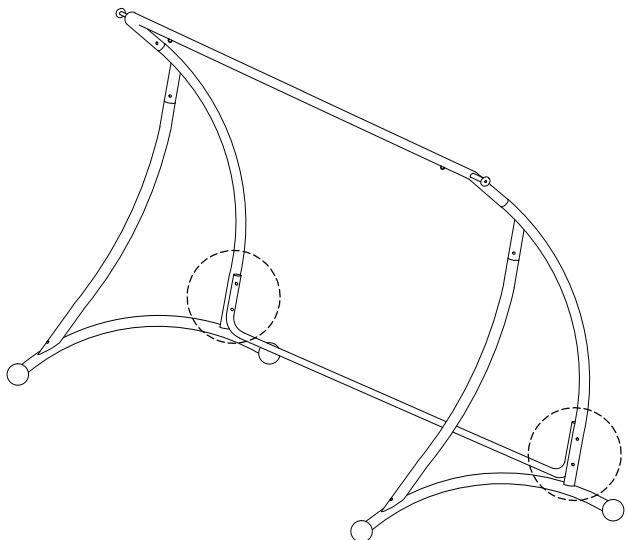

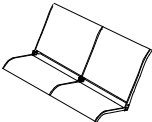

3

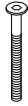
E	P3	T1	S1	N1	V	Z1
	 M8 x 80					 M8
x 1	x 4	x 4	x 4	x 4	x 1	x 1



4

<p>F</p>  <p>x 2</p>	<p>K</p>  <p>x 1</p>	<p>O</p>  <p>x 4</p>	<p>P4</p>  <p>M6 x 62 x 4</p>	
<p>T</p>  <p>x 4</p>	<p>P</p>  <p>x 4</p>	<p>N</p>  <p>x 4</p>	<p>V</p>  <p>x 1</p>	<p>Z2</p>  <p>M6 x 1</p>

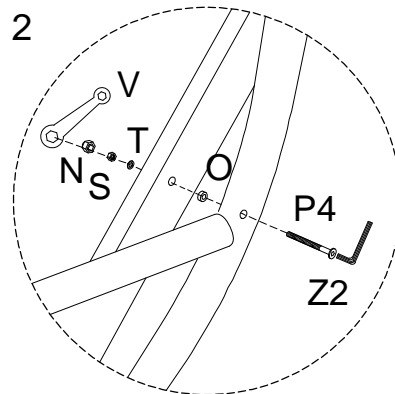
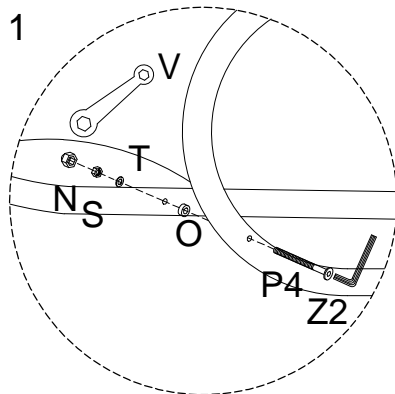
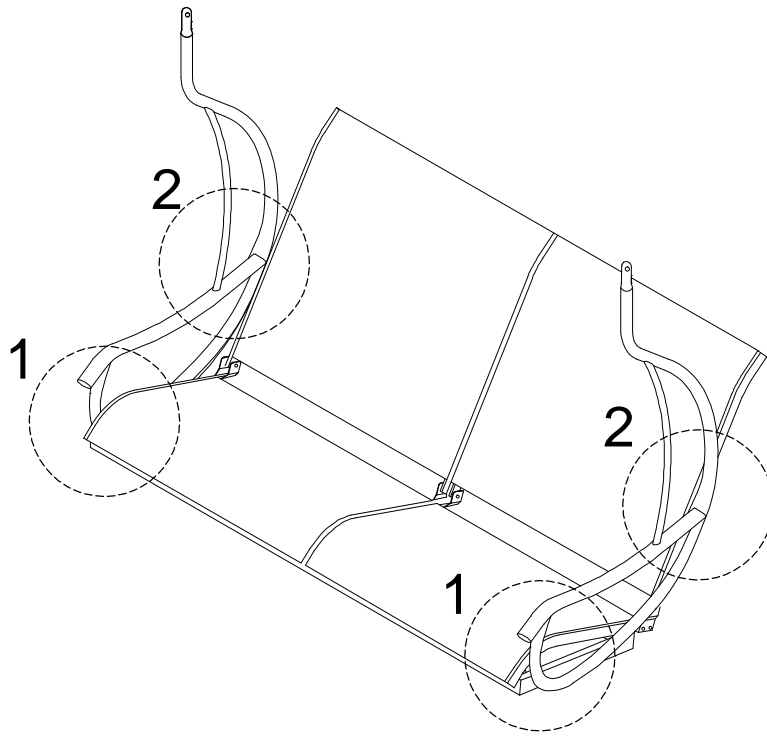

5

M

x 2

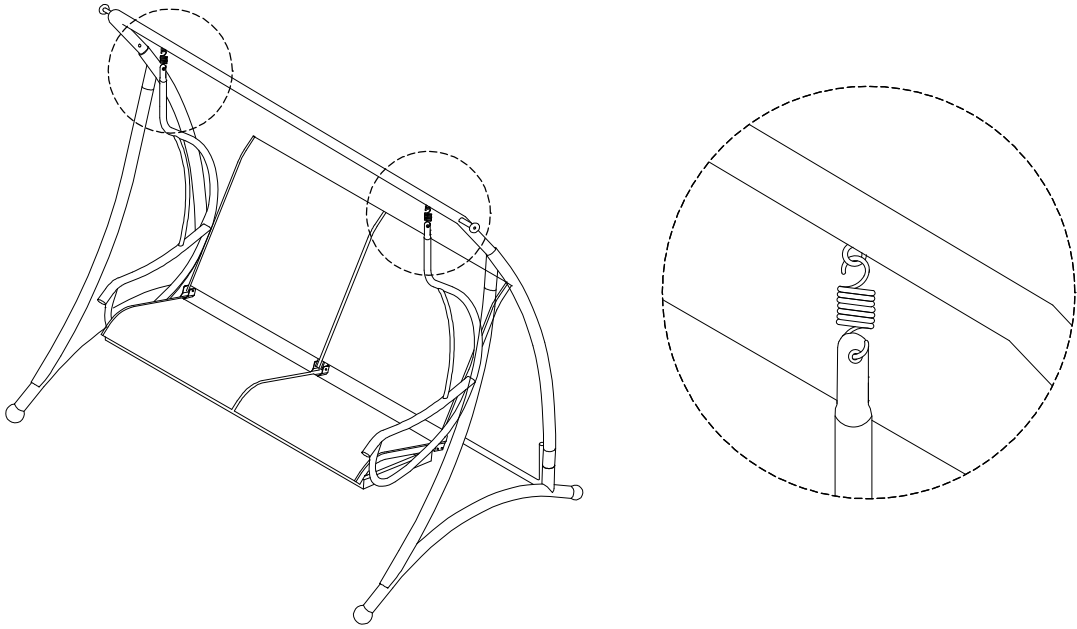

6

I

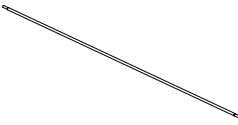
x 2

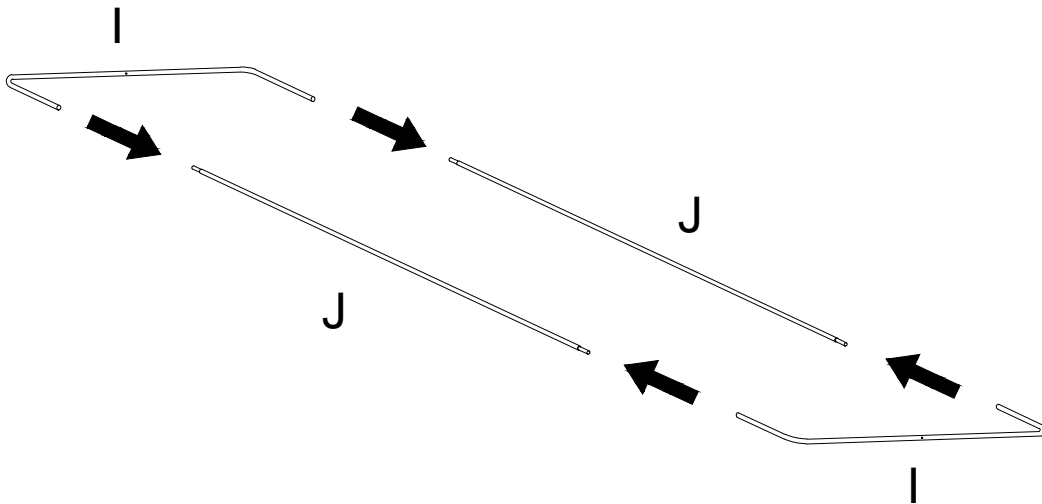
J

x 2

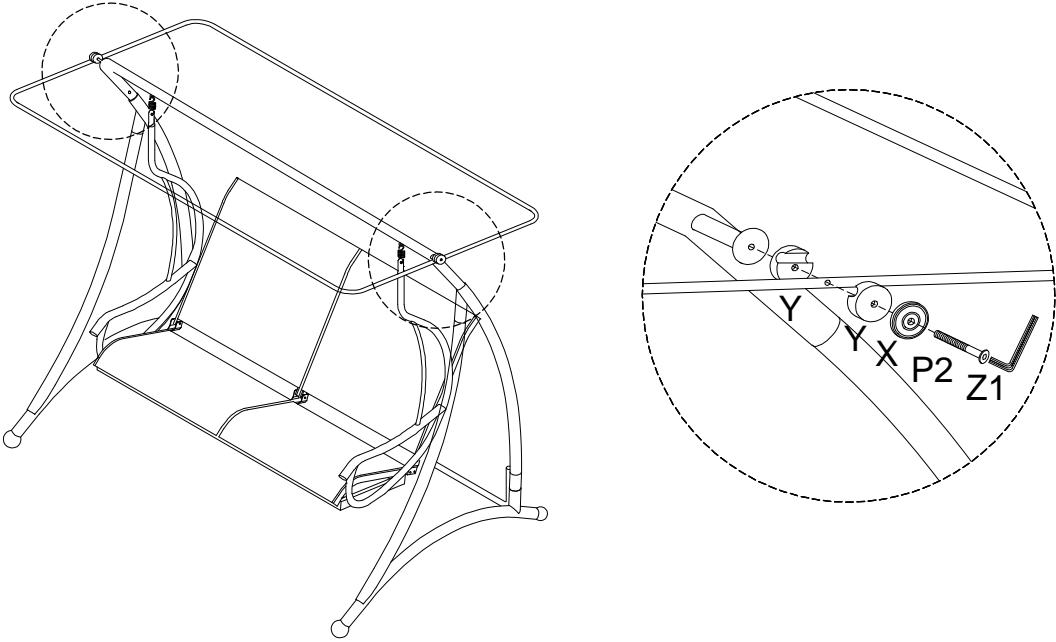
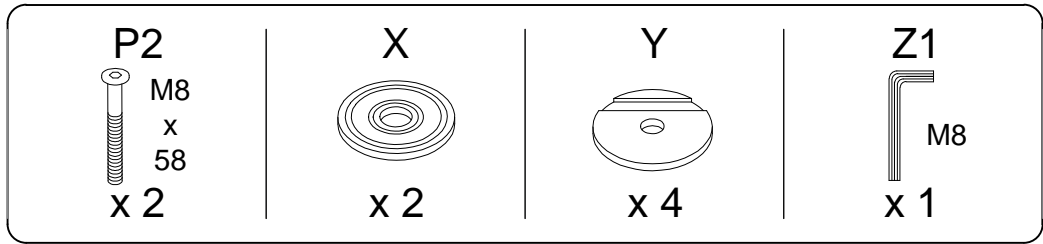

7



8

