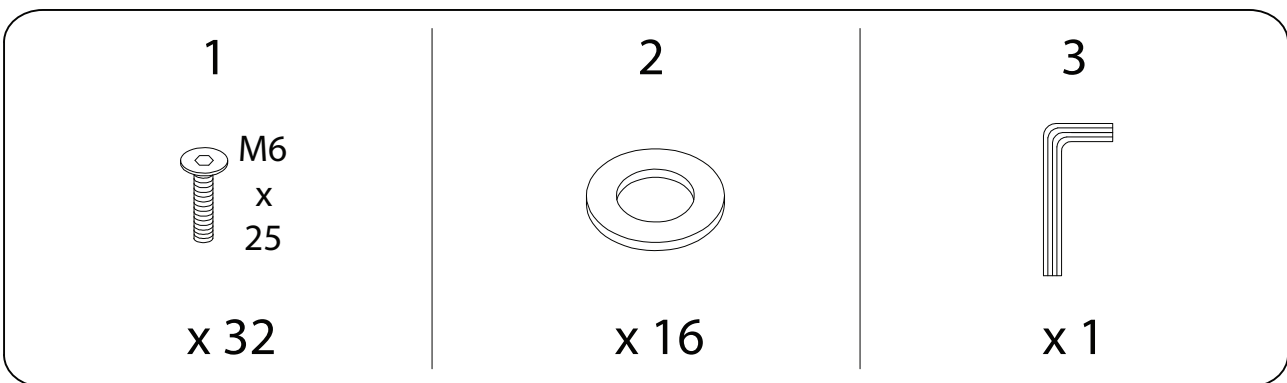
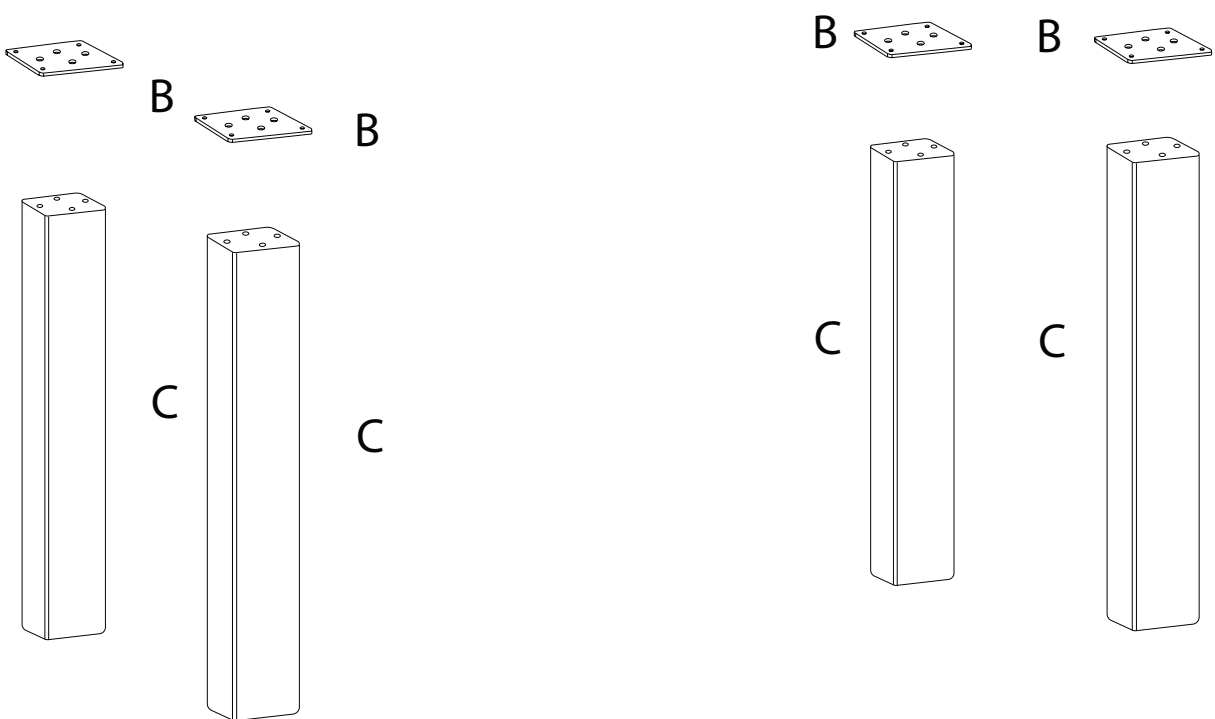
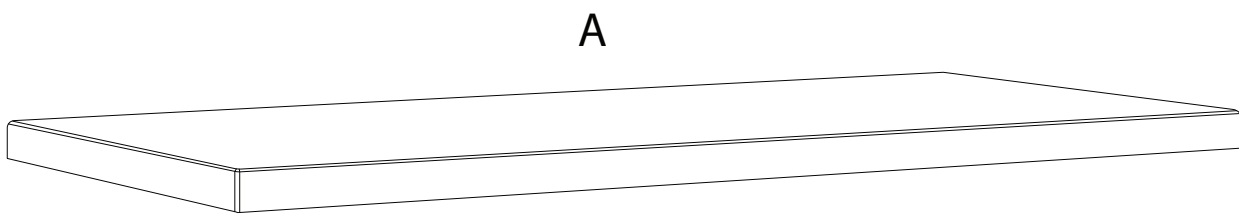
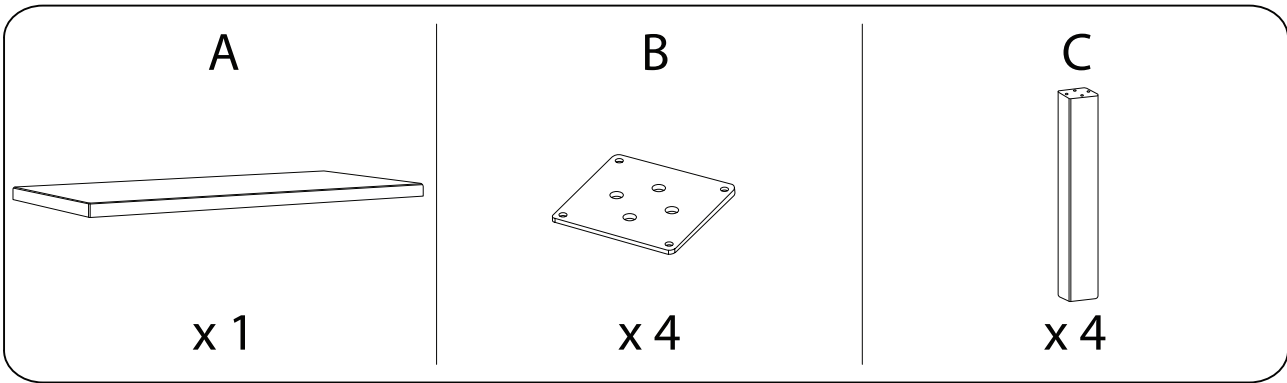
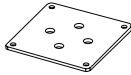





Diagram illustrating assembly instructions and safety warnings:

- Top Warning:** A warning triangle with an exclamation mark is connected by a vertical line to a box containing:
 - An icon of an L-shaped metal bracket.
 - An icon of a power drill with a diagonal line through it, indicating that a power drill should not be used.
- Bottom Warning:** A warning triangle with an exclamation mark is connected by a vertical line to a box containing:
 - An icon of a rectangular block being placed on a textured surface.
 - An icon of a rectangular block with a diagonal line through it, indicating that the block should not be placed on a soft or uneven surface.
- Time:** A clock icon with the text "30'" below it, indicating a 30-minute assembly time.
- Personnel:** An icon of a person with the number "2" below it, indicating that two people are required for assembly.



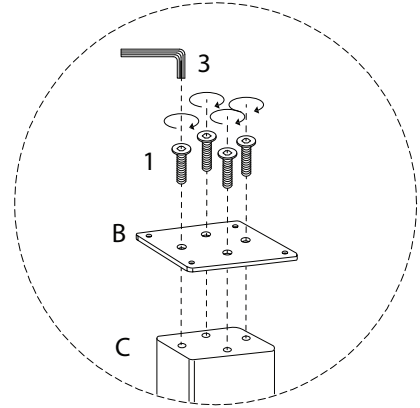
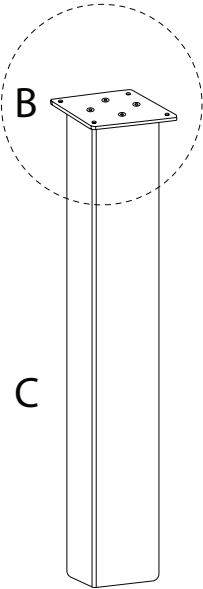

1 x 4

B  x 1	C  x 1	1  M6 x 25 x 4	3  x 1
--	--	---	--

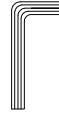

2

A  x 1	1  M6 x 25 x 16	2  x 16	3  x 1
--	---	--	--

