











A		4*30	54
B		M6*40	18
C			2
D		Φ8*30	16
E		Φ7*60	4
F		M6*60	6
G		M6*60	24
H			1



STEP:1

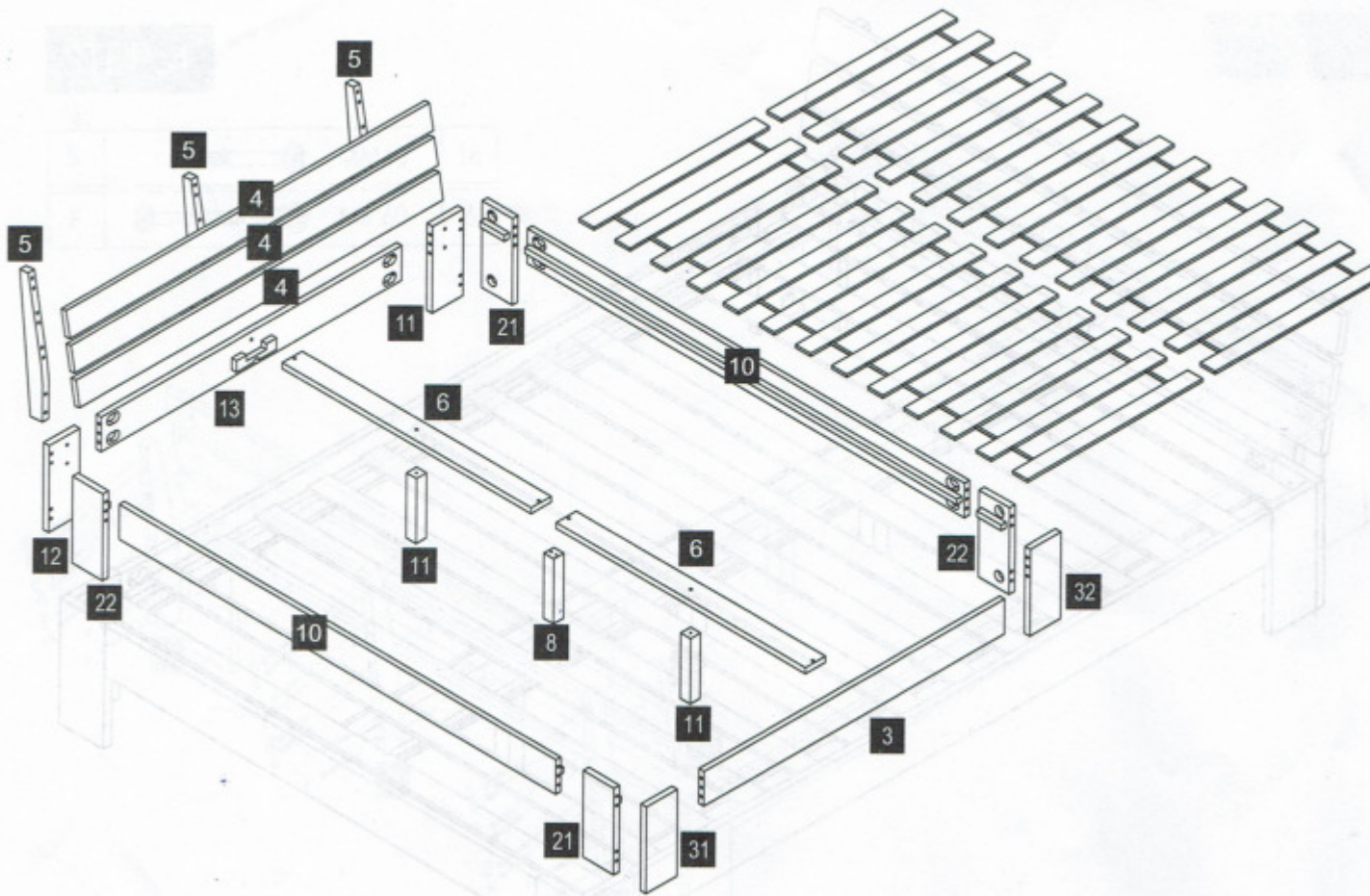
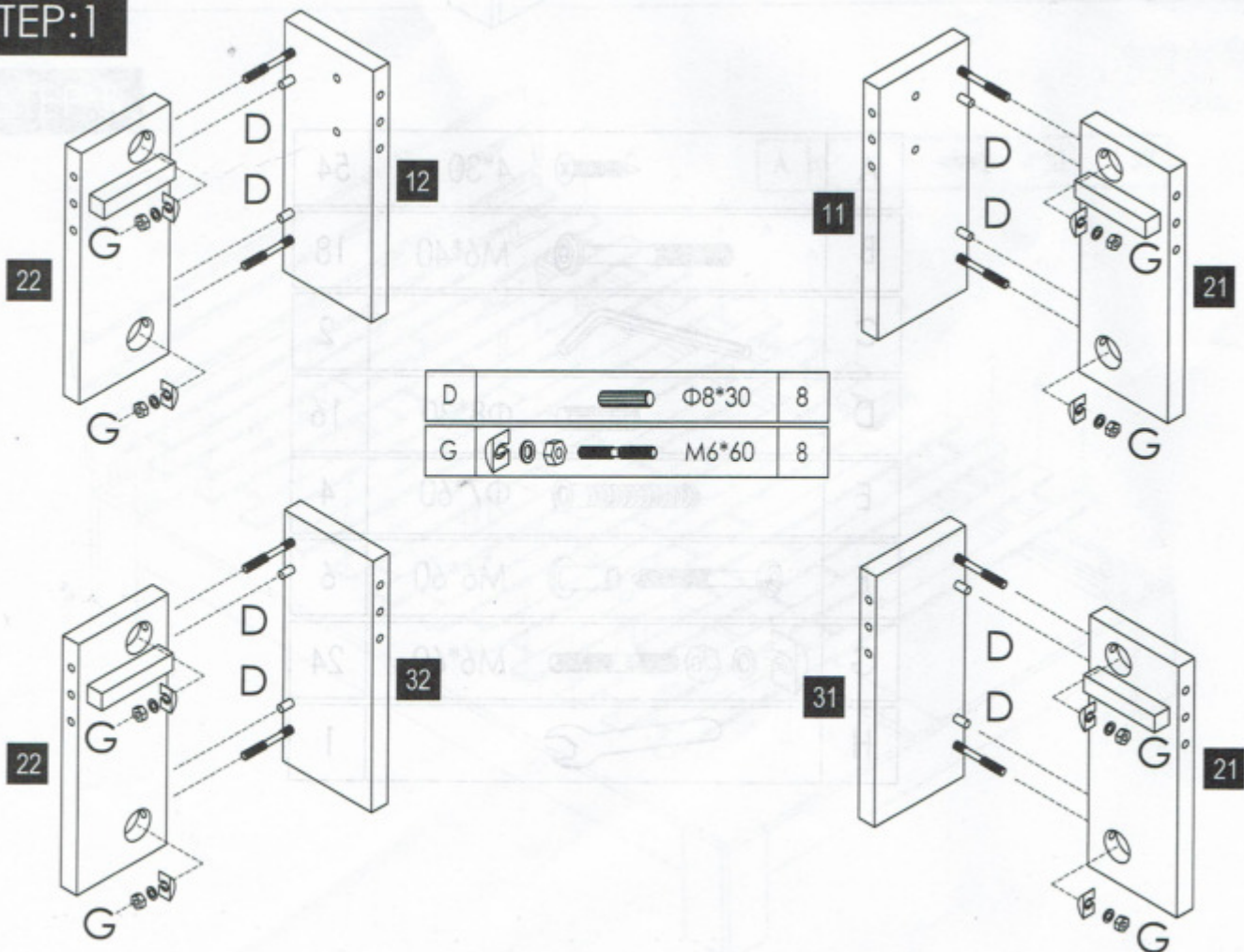

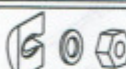

STEP:2

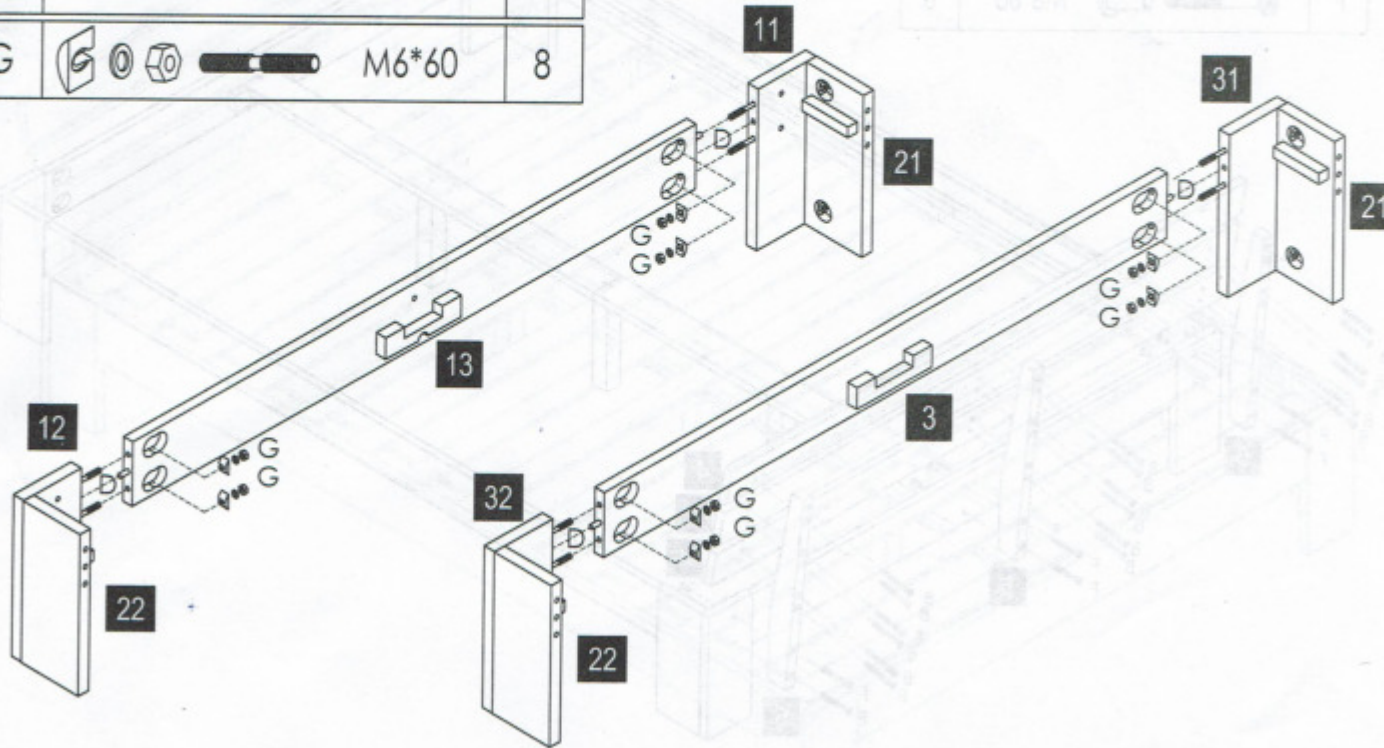
D		$\Phi 8 \times 30$	4
G		M6*60	8



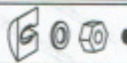

STEP:3

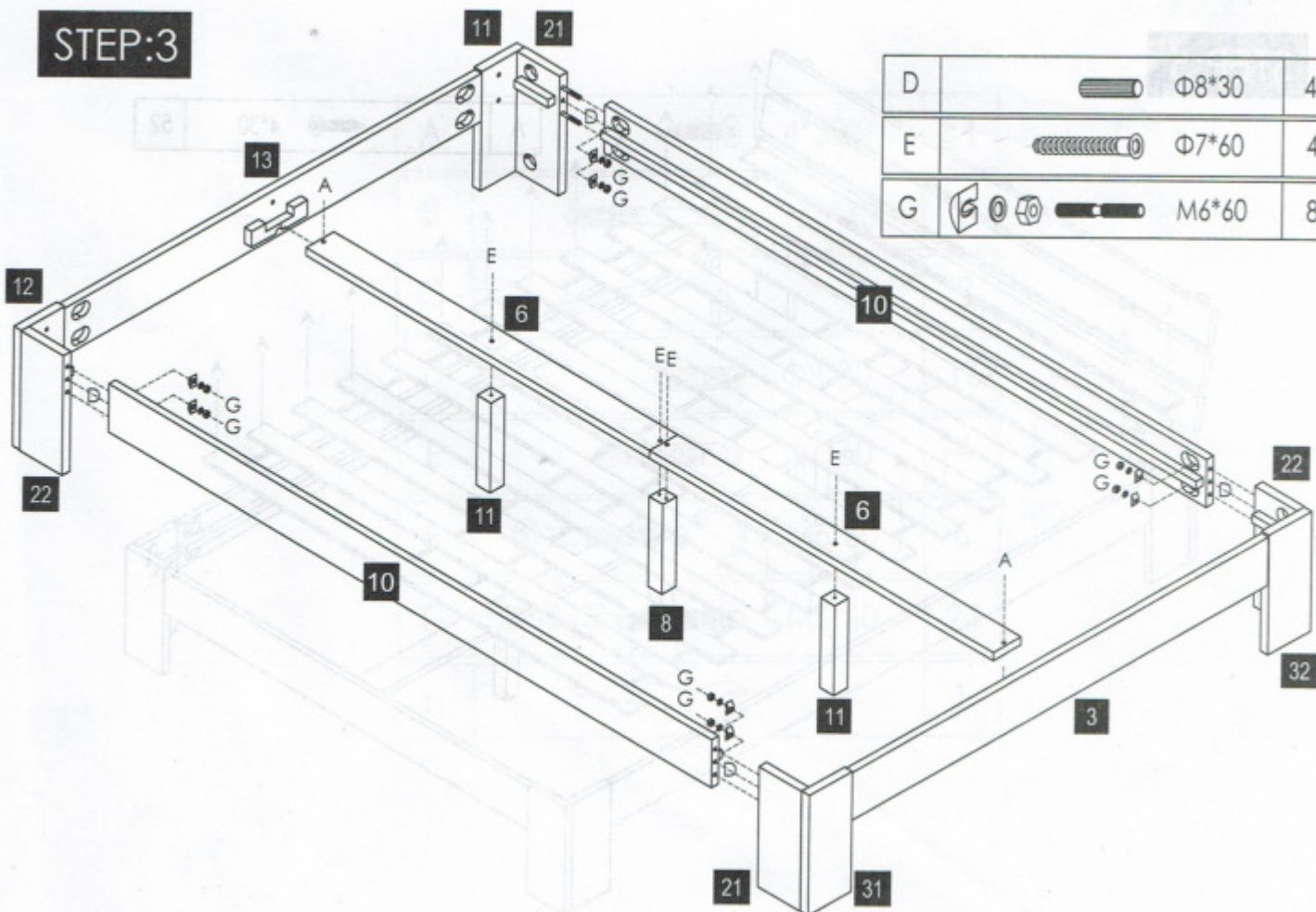
D		$\Phi 8 \times 30$	4
E		$\Phi 7 \times 60$	4
G		M6*60	8

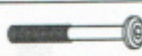

STEP:4

B		M6*40	18
F		M6*60	6

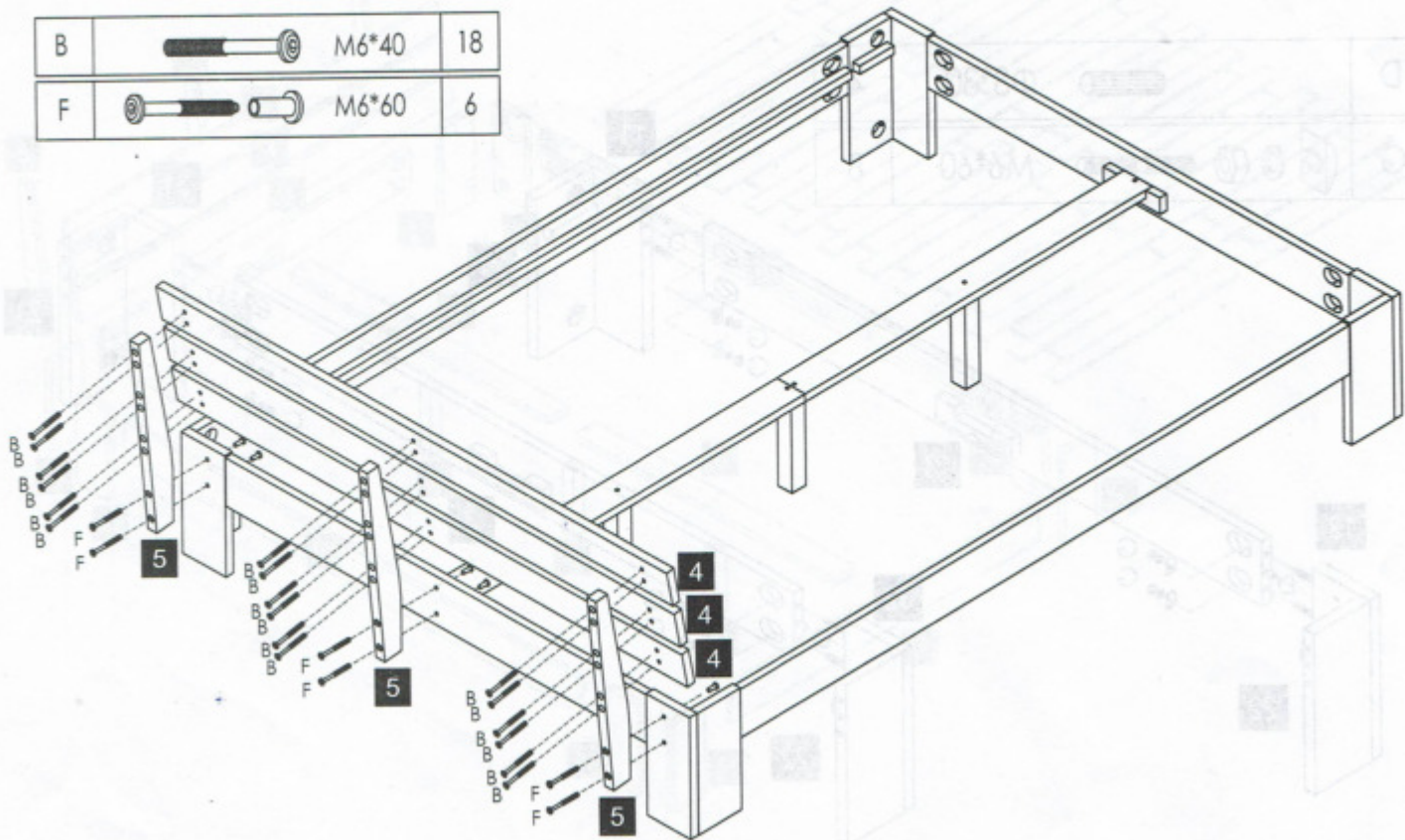

STEP:5

A		4*30	52
---	---	------	----

