

		20'
		1

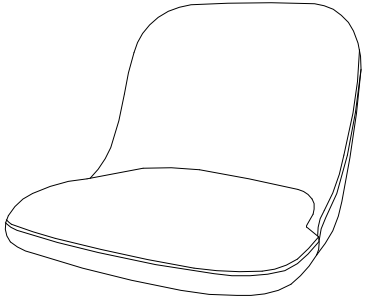

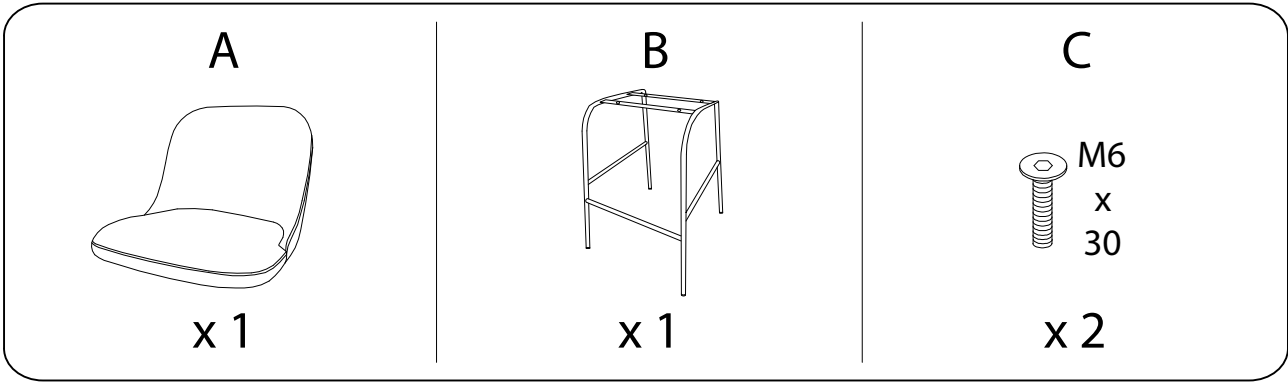

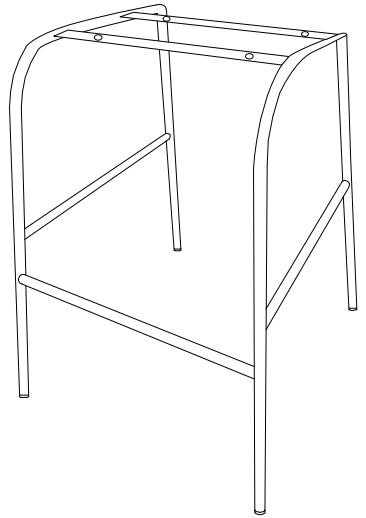

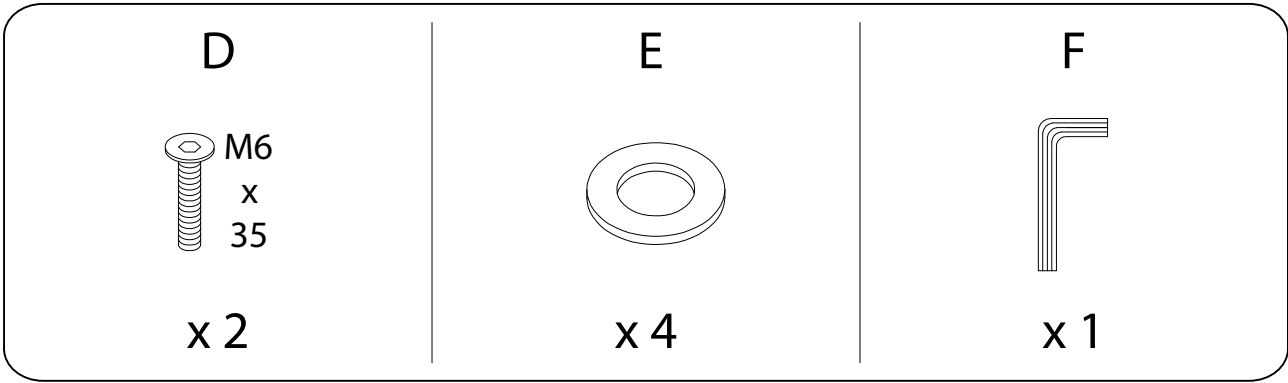

A



B



1

A  x 1	B  x 1	C  M6 x 30 x 2	D  M6 x 35 x 2	E  x 4	F  x 1
--	--	---	---	--	--

