

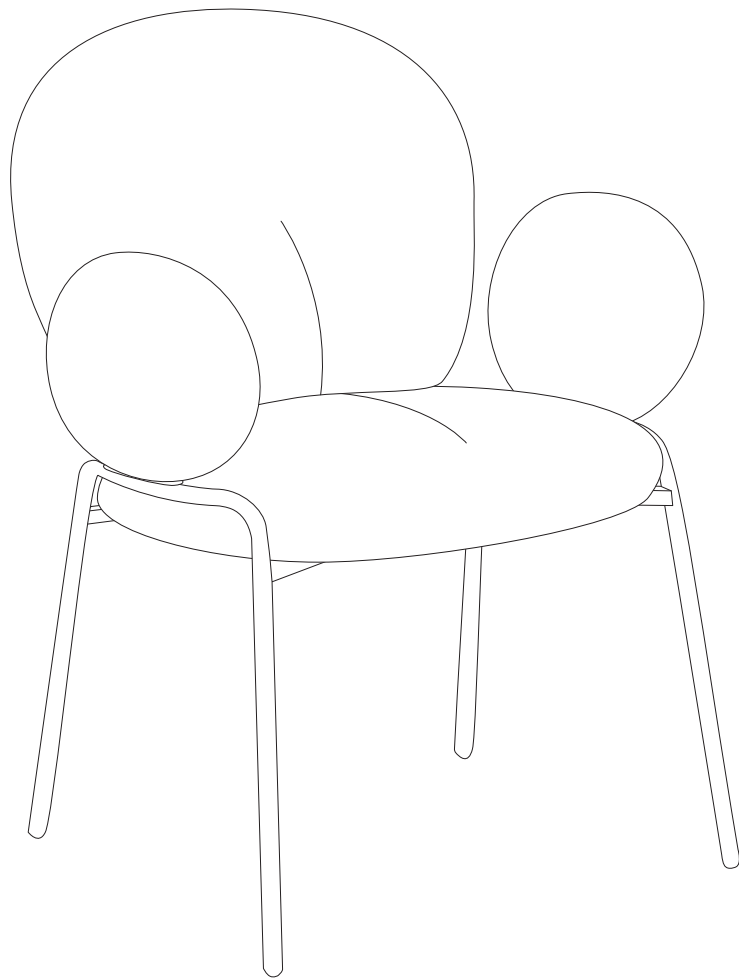

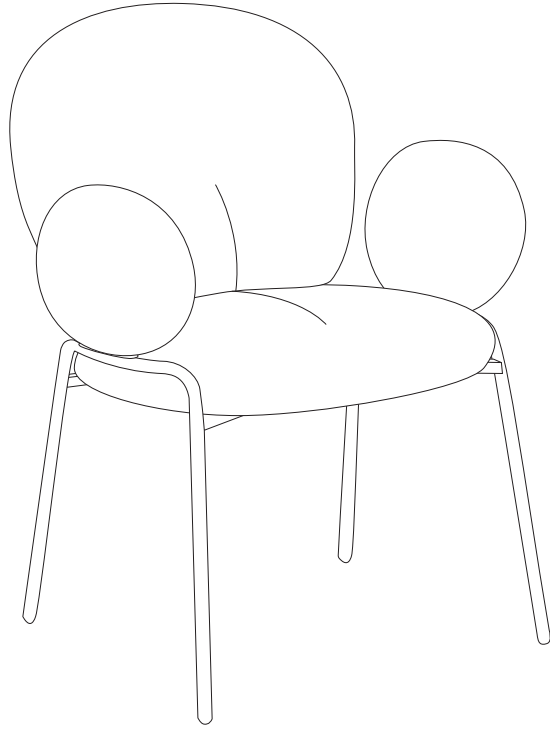

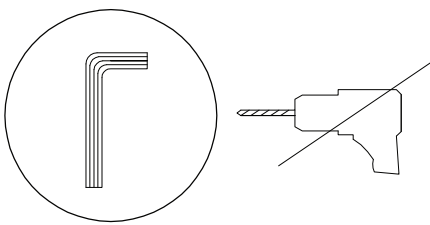

ELY

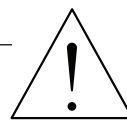
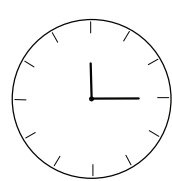
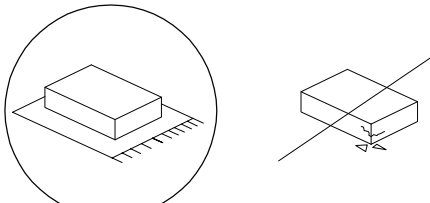
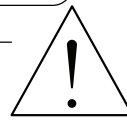



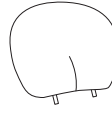

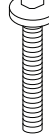
| | | |
|---|---|---|
|  |  |  |
| | | 15' |
|  |  |  |
| | | 1 |

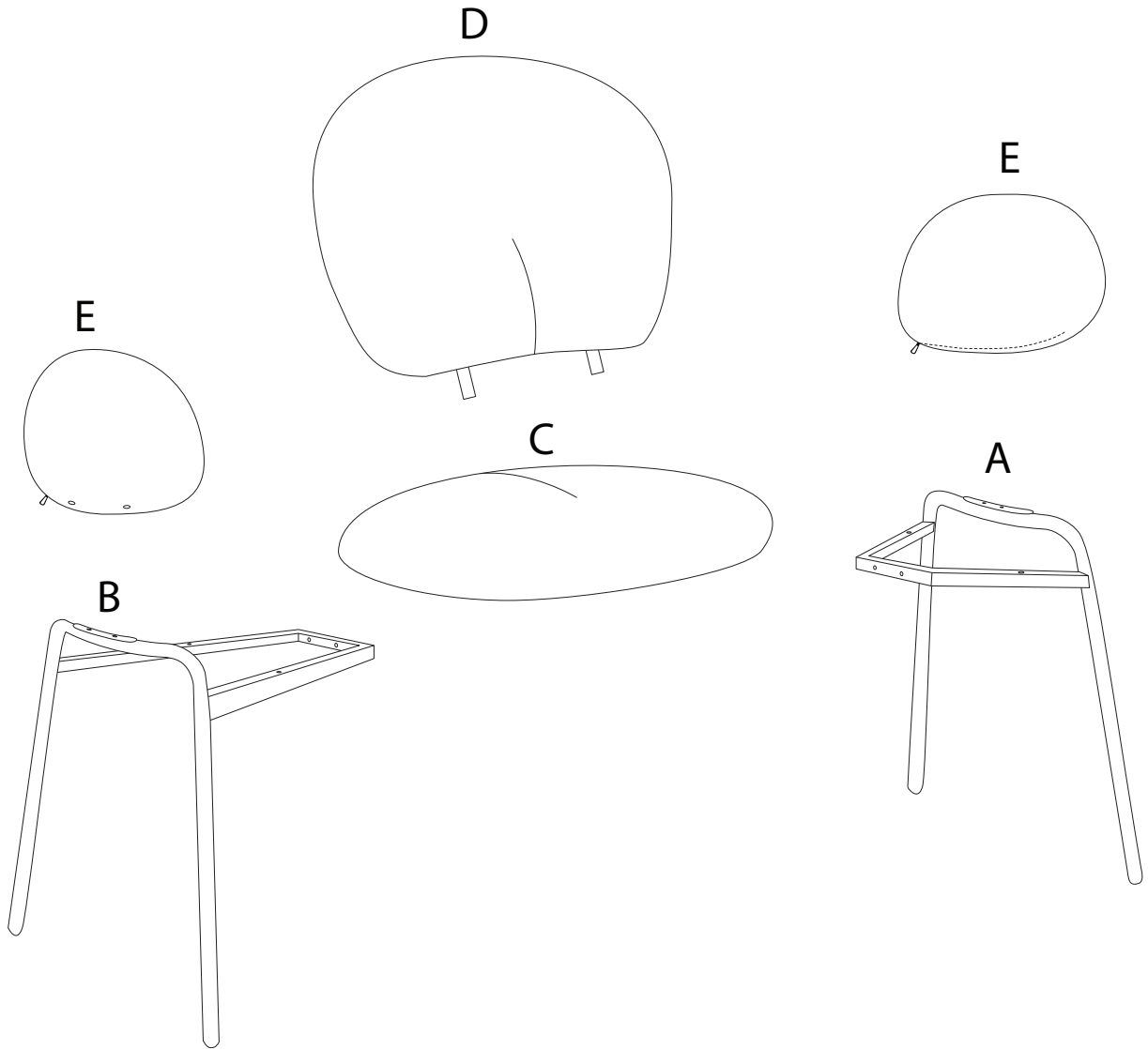
| | | | | | |
|---|---|---|---|---|---|
| A | B | C | D | E | F |
|  |  |  |  |  |  M6 x 35 |
| x 1 | x 1 | x 1 | x 1 | x 2 | x 4 |

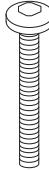
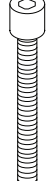

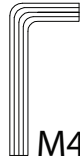
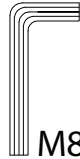
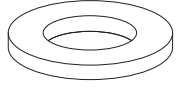
| | | | | | |
|---|--|---|--|--|---|
| G | H | I | J | K | L |
|  M6 x 45 |  M10 x 50 |  Ø18 |  M4 |  M8 |  Ø30 |
| x 6 | x 2 | x 2 | x 1 | x 1 | x 2 |

1

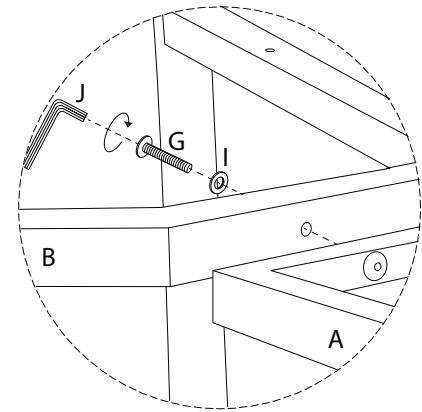
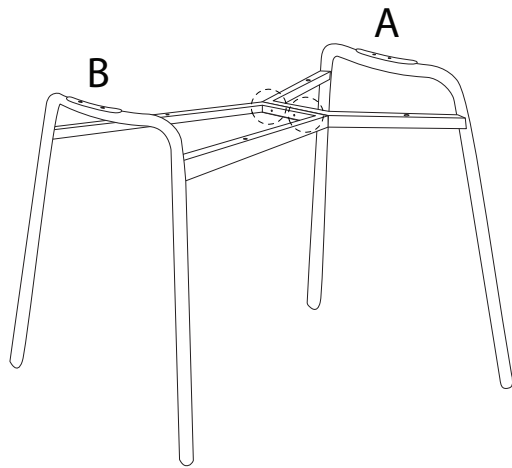
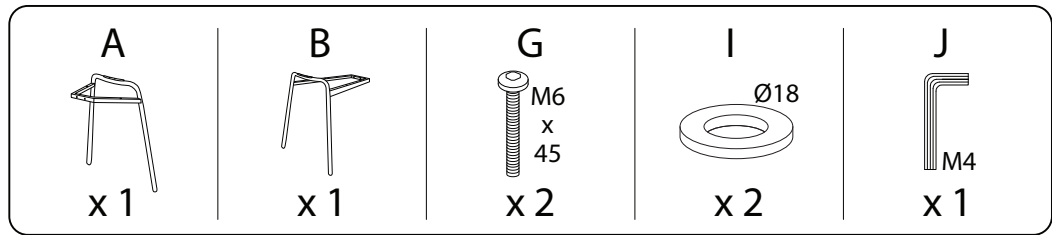

2

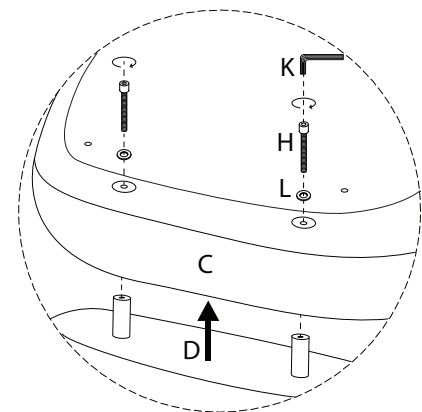
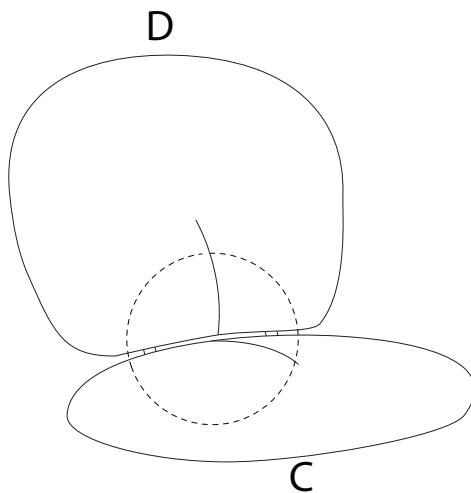
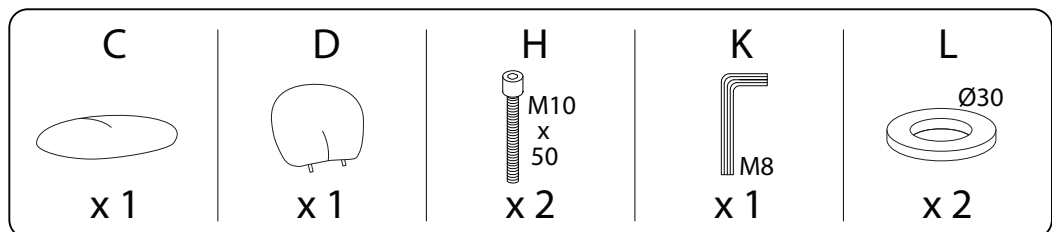

3

F
M6
x
35
x 4

J
M4
x 1

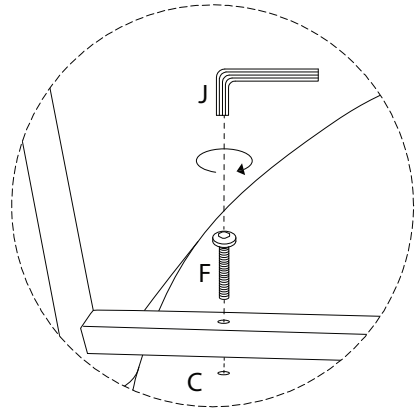
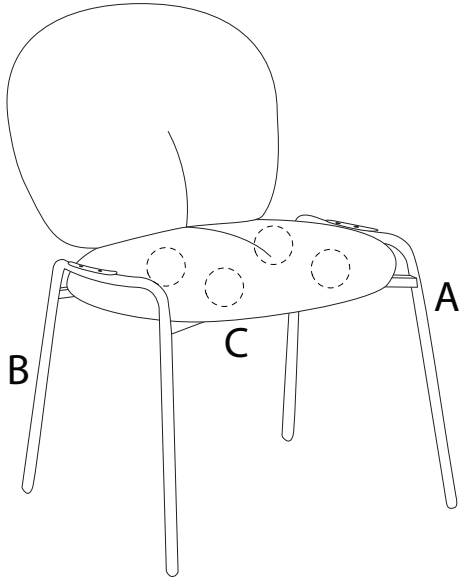

4

E
x 2

G
M6
x
45
x 4

J
M4
x 1

