

Aufbauanleitung
Assembly Instructions

Garbage Bin
Model Number:

HM-NGB-3

Item Number #73378,#73379,#73380



Mendler Vertriebs-GmbH
Industriestr. 60
73642 Welzheim

fragen@heute-wohnen.de

www.heute-wohnen.de

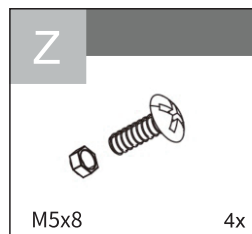
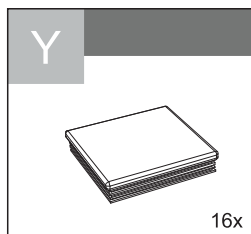
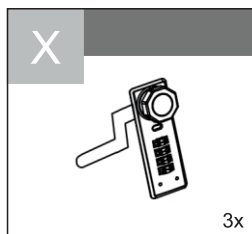
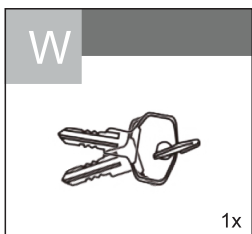
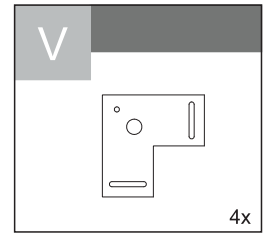
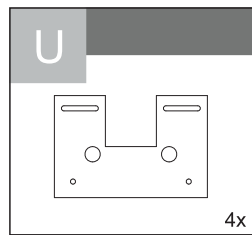
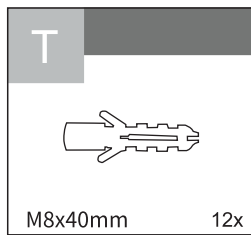
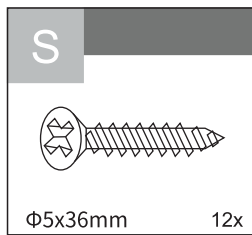
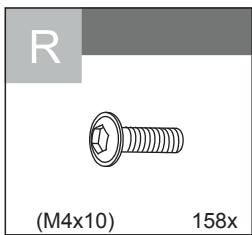
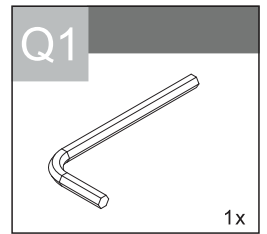
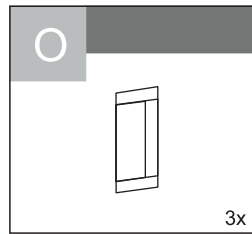
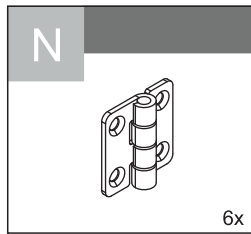
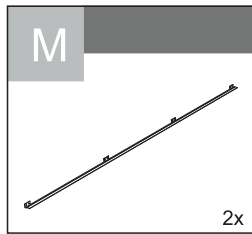
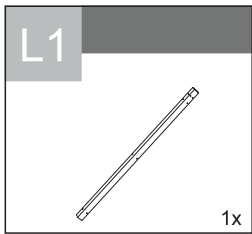
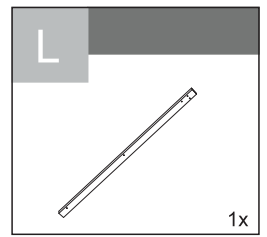
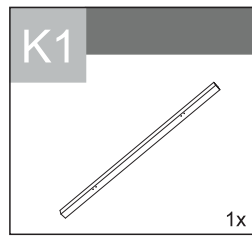
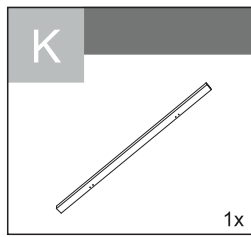
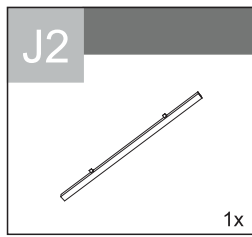
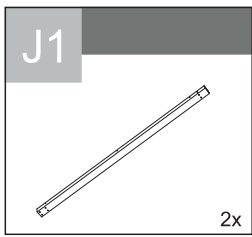
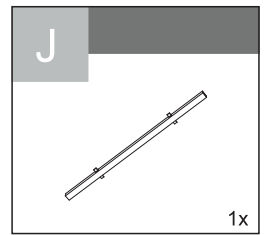
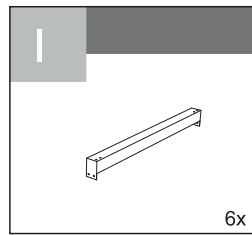
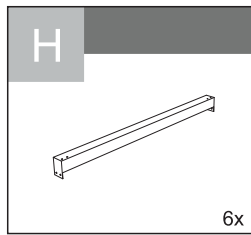
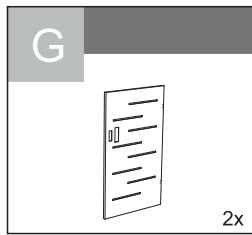
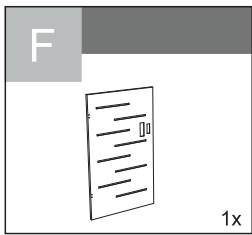
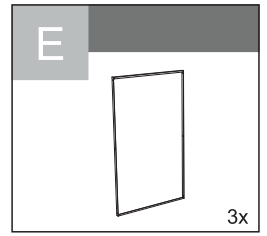
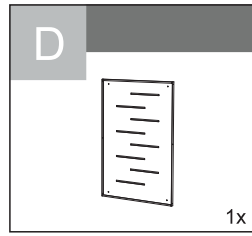
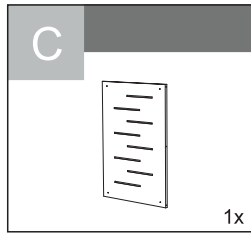
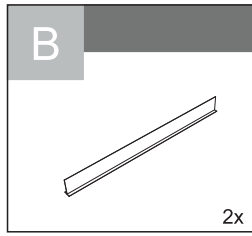
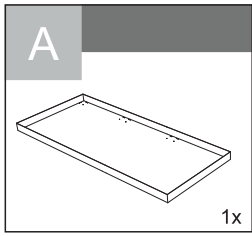

1

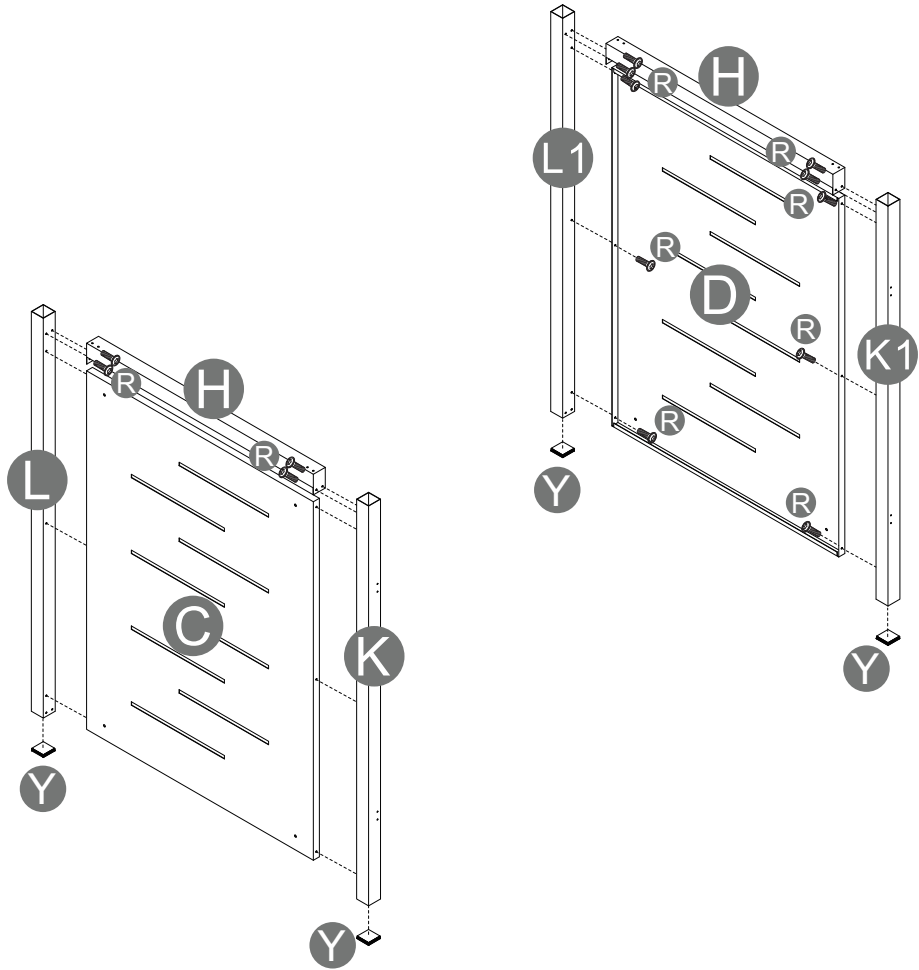

2

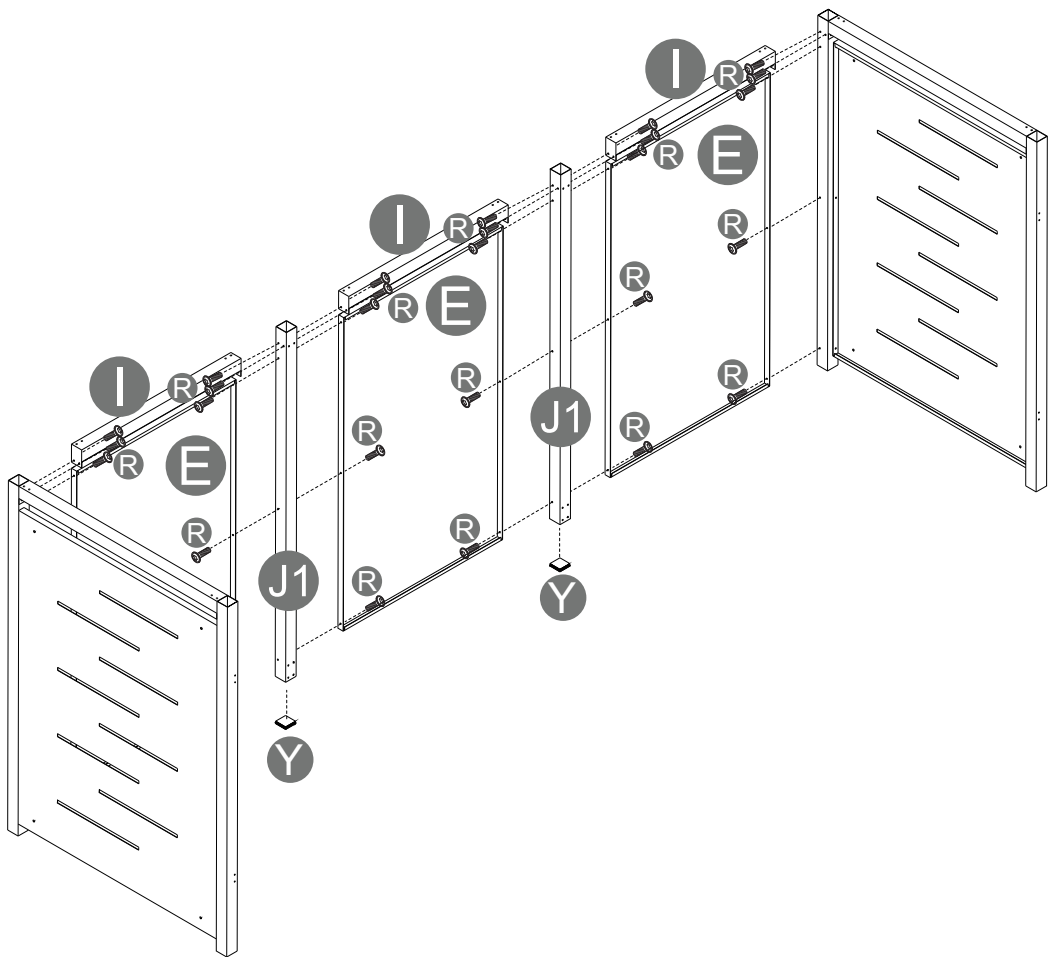

3

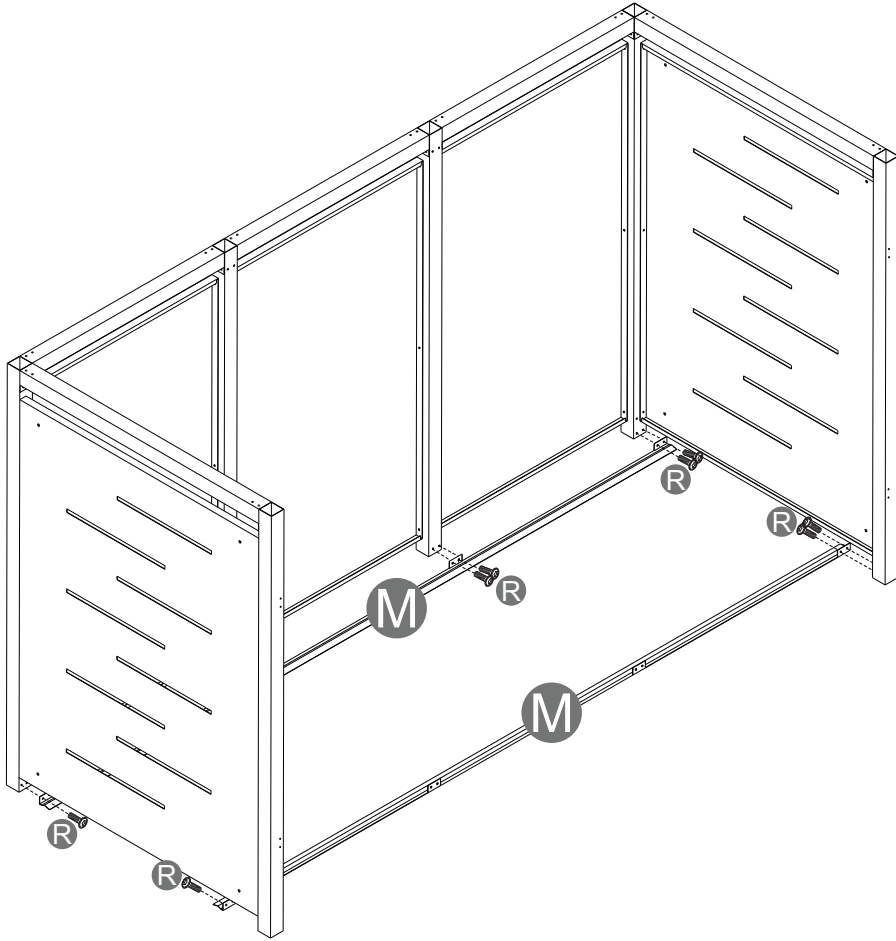

4

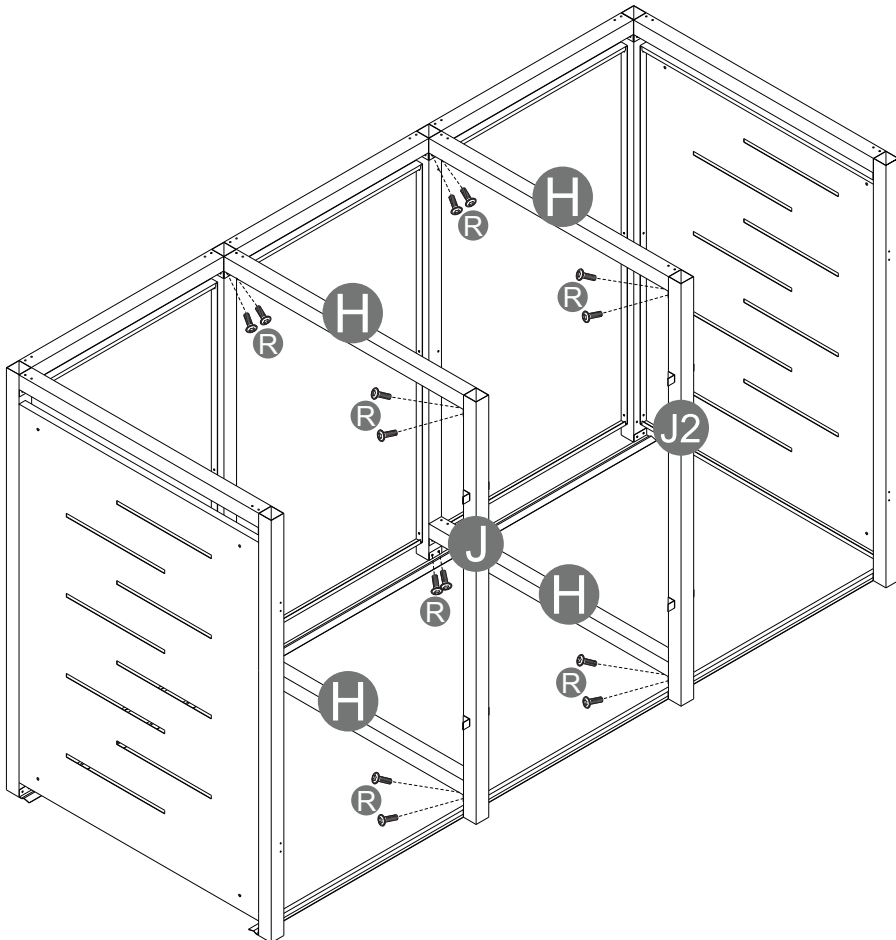

5

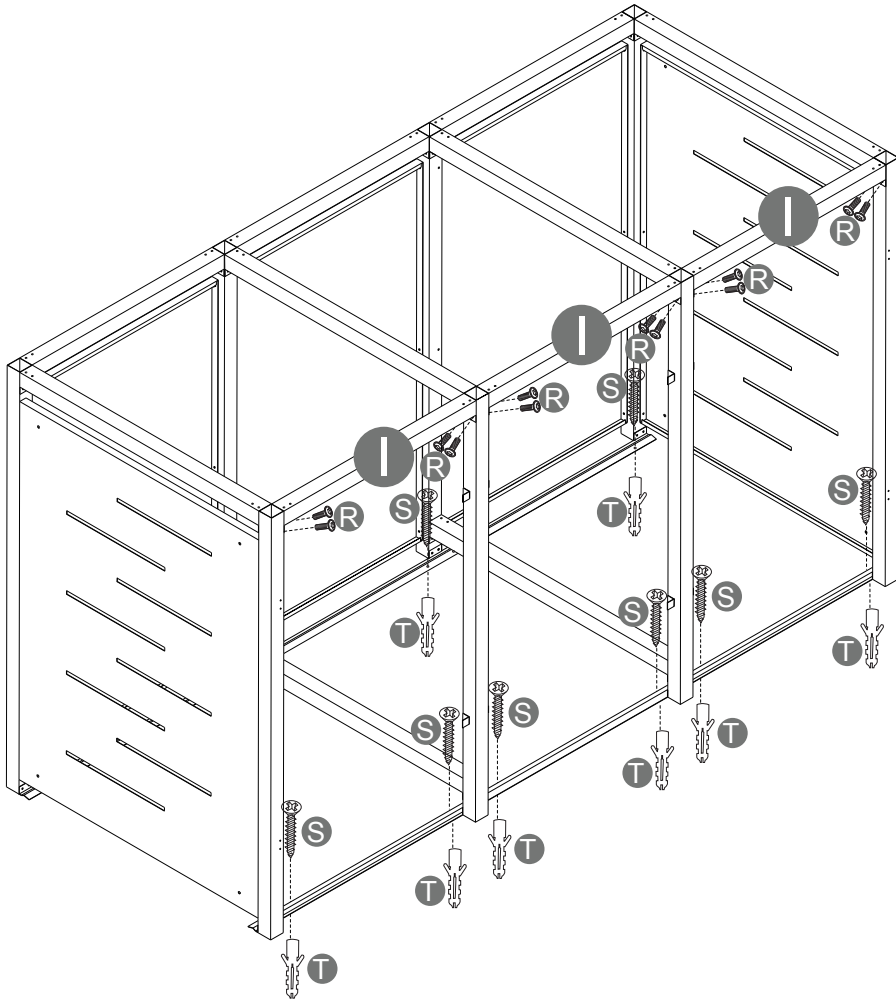

6

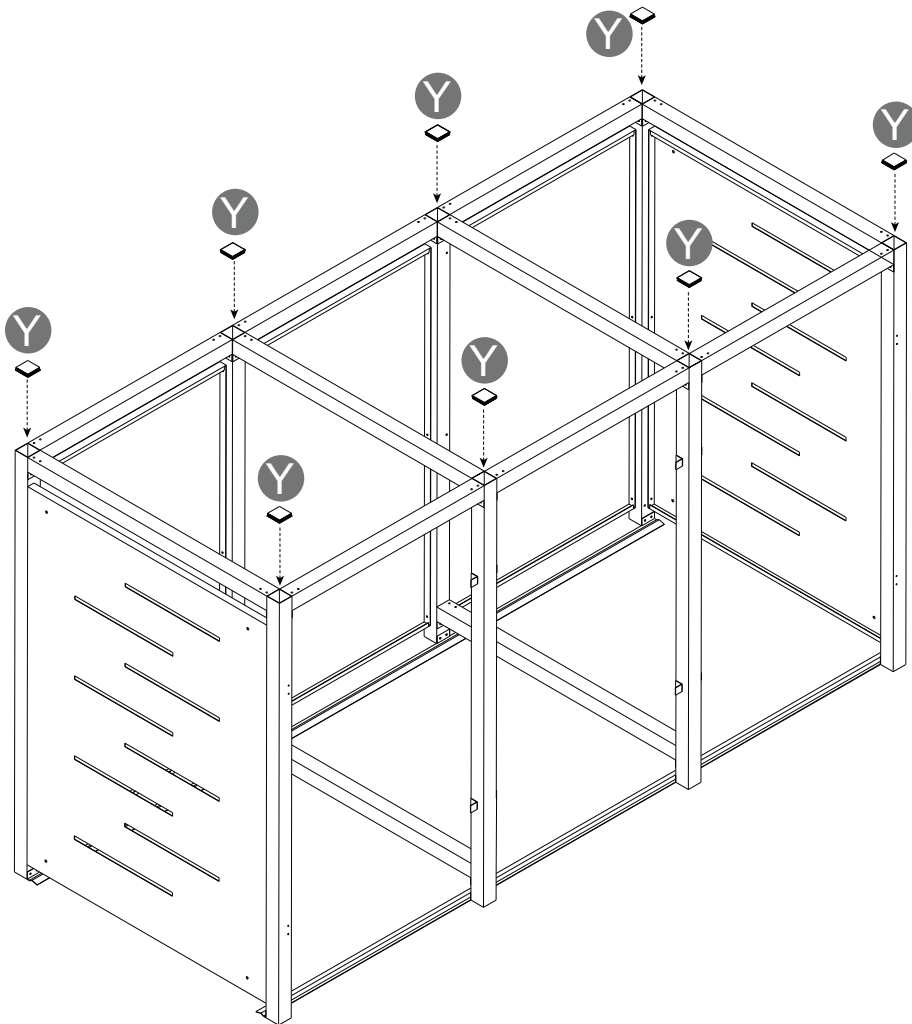

7

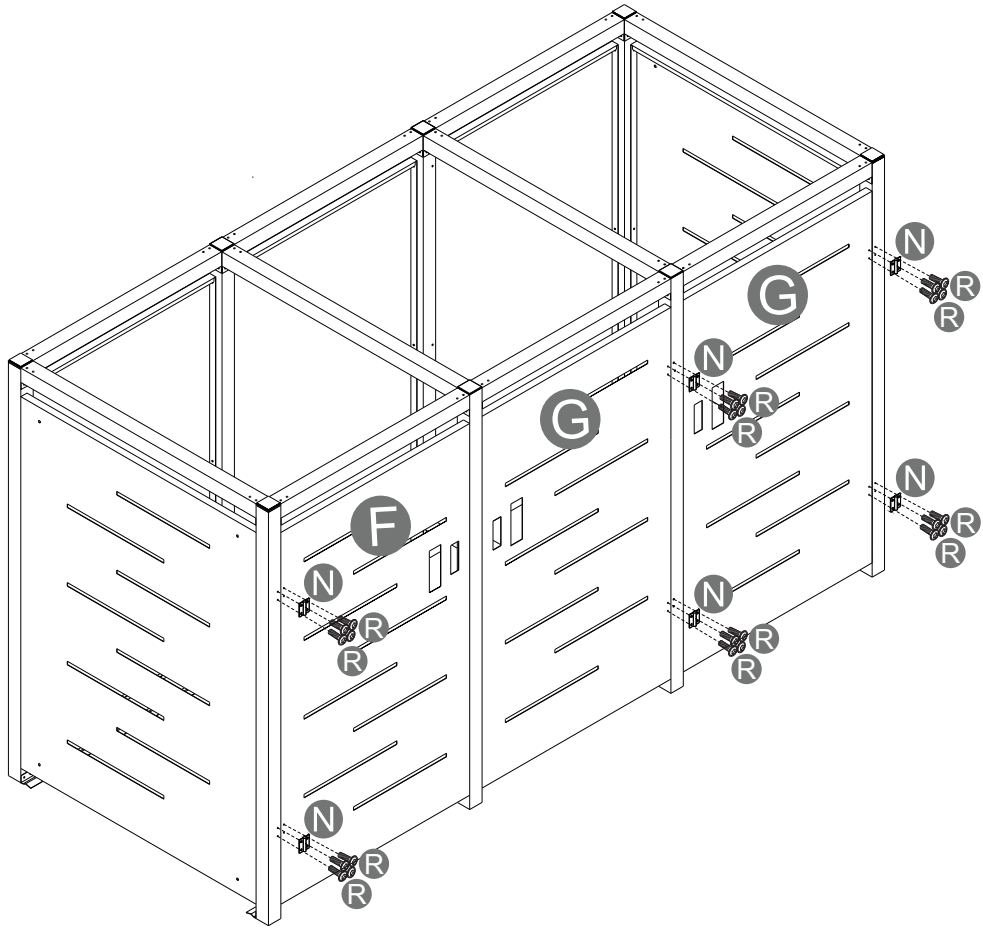

8

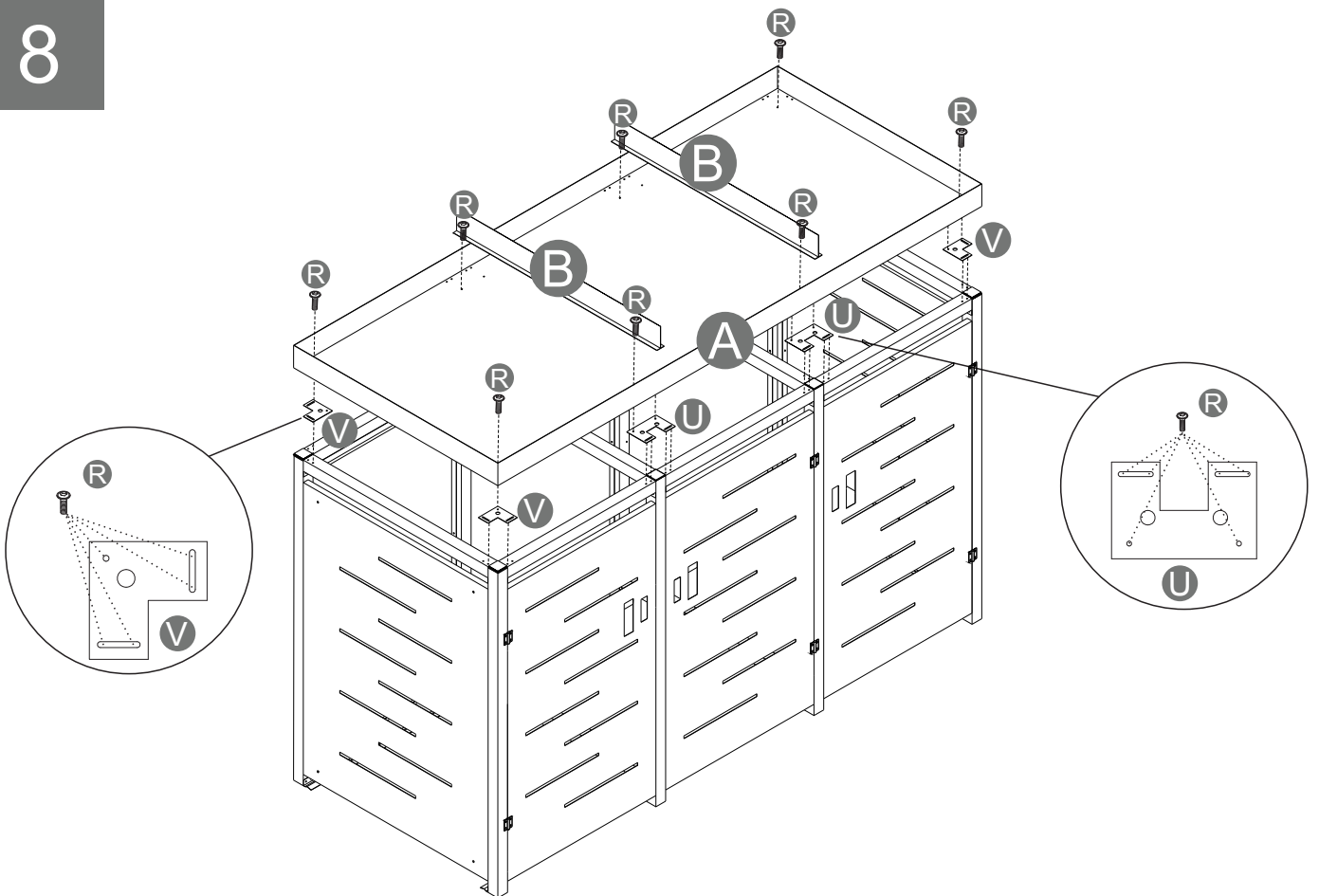

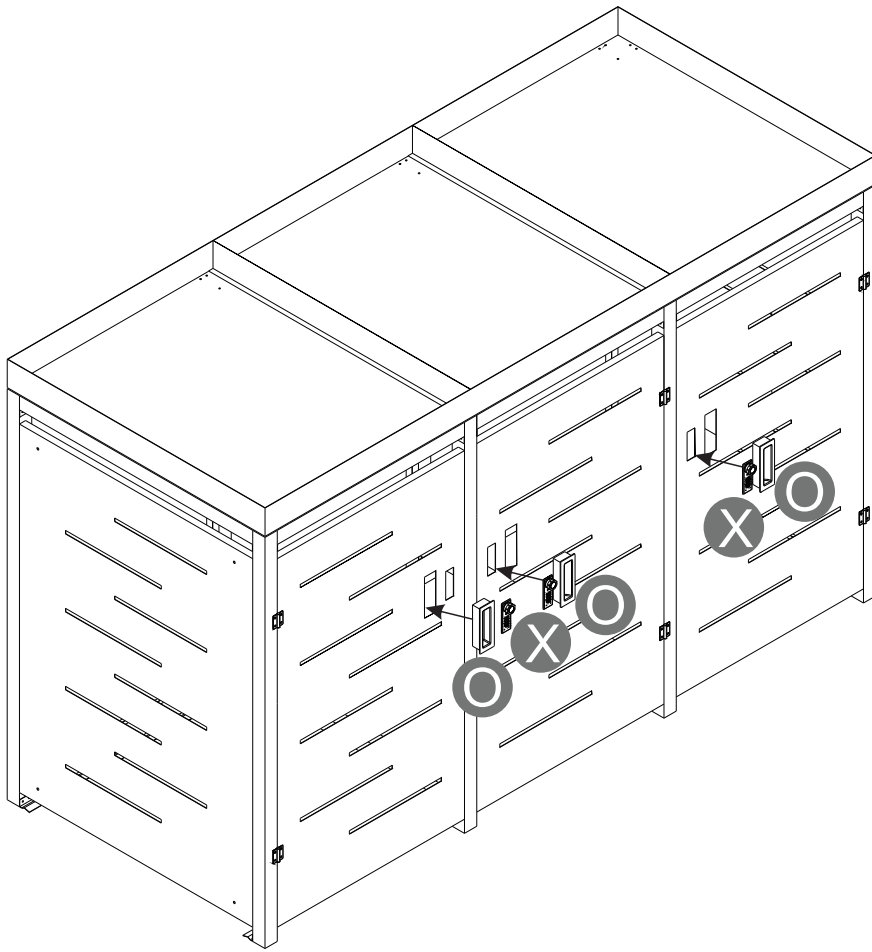

110

140



MECHANICAL LOCKER INSTRUCTION MANUAL

1. Lock & Unlock

1. ☹️ = CLOSE
 ↓
 5. 😊 = OPEN
 Turn the knob to OPEN position

2.
 Turn the knob to close position

3.
 input correct password to open

4.
 Turn the knob to OPEN position

5. OPEN
 ! Door open. But at OPEN position, you can not change password

2. Password changing

6. = 0|0|0|0
 ↓
 10. 😊 = 1|6|8|8
 Default password:0-0-0-0

7.
 1.PERSONAL
 2.PUBLIC
 3.CODE RESET
 Front side
 Back side
 Turn knob to "OPEN" position, and back side button to 2 PUBLIC mode

8.
 Turn the knob to CHANGE position

9.
 10. = 1|6|8|8 = ✓
 ! change your password

3. Password changing at private mode

11. ☹️ = 1|6|8|8
 ↓
 15. 😊 = 8|8|8|8
 Current password:1-6-8-8

12.
 1.PERSONAL
 2.PUBLIC
 3.CODE RESET
 Front side
 Back side
 Turn knob to "OPEN" position, and back side button to 2 PUBLIC mode

13.
 Turn the knob to CHANGE position

14.
 1.PERSONAL
 2.PUBLIC
 3.CODE RESET
 Front side
 Back side
 Turn knob to "CLOSE" position, and back side button to 1 PERSONAL mode

15. = 8|8|8|8 = ✓
 ! Password can not be changed

4. Password finding by emergency key

16. ☹️ = ☹️ ☹️ ☹️ ☹️
 ↓ +
 18. 😊 = ☹️ ☹️ ☹️ ☹️

17.
 Turn the digit wheel one by one till wheel can not move

19. !
 19.1
 19.2
 19.3

20.
 1.PERSONAL
 2.PUBLIC
 3.CODE RESET
 Front side
 Back side
 ! at PERSONAL mode, password can't be found by emergency key

21. ☹️ = ☹️ ☹️ ☹️ ☹️
 ↓ +
 24. 😊 = ☹️ ☹️ ☹️ ☹️

22.
 Holding the right wheel and the left wheel, turn the right wheel one by one till the wheel can not move

5. Password finding by emergency bar

23.
 ☹️ = ☹️ ☹️ ☹️ ☹️ !
 ! Password can not be changed

24.

Note: This step can be operated only when the door is open.













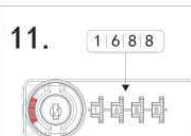



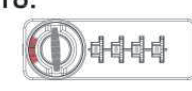

MECHANICAL LOCKER INSTRUCTION MANUAL

1. Öffnen und Schließen

<p>1. ☹️ = schließen </p> <p>↓</p> <p>5. 😊 = öffnen </p>	<p>1. </p> <p>Drehen Sie den Drehknopf auf "close"</p>
<p>2. </p>	<p>3. </p> <p>korrektes Passwort zum Öffnen eingeben</p>
<p>4. </p> <p>Drehknopf auf "open" drehen</p>	<p>5. offen</p> <p>öffnen</p>

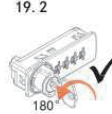
2. Passwort ändern

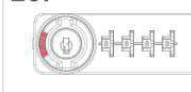
<p>6. = 0 0 0 0</p> <p>↓</p> <p>10. 😊 = 1 6 8 8</p>	<p>6. = 0 0 0 0</p> <p>voreingestelltes Passwort 0-0-0-0</p>
<p>7. </p> <p>1.PERSONAL 2.PUBLIC 3.OPEN 4.PASSBY</p> <p>Frontseite Drehen Sie den Drehknopf zu "open" und auf der Rückseite auf "2 Public"</p>	<p>8. = 1 6 8 8</p> <p>stellen Sie den Drehknopf auf "change"</p>
<p>9. </p>	<p>10. = 1 6 8 8 = ✓</p> <p>! ändern Sie ihr Passwort</p>

3. Passwort ändern im Private mode		4. Passwort mithilfe des Notfallschlüssels eingeben		5. Passwort mithilfe des Notfallstabs eingeben	
<p>11. ☹️ = 1 6 8 8</p> <p>↓</p> <p>15. 😊 = 8 8 8 8</p>	<p>11. 1 6 8 8</p>  <p>derzeitiges Passwort 1-6-8-8</p>	<p>16. ☹️ = 3 5 7 9 6 4 7 0</p> <p>↓ + </p> <p>18. 😊 = 8 8 8 8</p>	<p>16. 16.1</p>  <p>16.2</p> 	<p>20.</p>  <p>1.PERSONAL 2.PUBLIC 3.CODE RESET</p> <p>Frontseite Rückseite</p> <p>! auf "Personal mode" kann das Passwort nicht mit dem Schlüssel gefunden werden</p>	<p>21. ☹️ = 3 5 7 9 6 4 7 0</p> <p>↓ + </p> <p>24. 😊 = 8 8 8 8</p>
<p>12.</p>  <p>1.PERSONAL 2.PUBLIC 3.CODE RESET</p> <p>Frontseite Rückseite</p> <p>Drehen Sie den Drehknopf auf "open" und die Rückseite auf "2 Public mode"</p>	<p>13. 8 8 8 8</p> <p>Drehen Sie den Drehknopf auf "change"</p> 	<p>17.</p>  <p>Drehen Sie die Drehfelder, eines nach dem Anderen, bis es sich nicht mehr bewegt</p>	<p>18.</p>  <p>😊 = 8 8 8 8 !</p>	<p>21.</p> 	<p>22.</p> 
<p>14.</p>  <p>1.PERSONAL 2.PUBLIC 3.CODE RESET</p> <p>Frontseite Rückseite</p> <p>Drehen Sie den Drehknopf auf "close" und die Rückseite auf "1 Personal mode"</p> <p>Dieser Schritt kann nur mit geöffneter Tür durchgeführt werden</p>	<p>15.</p> <p>8 8 8 8 = ✓</p> <p>! Passwort kann nicht geändert werden</p>	<p>19.</p> <p>19.1</p>  <p>19.2</p>  <p>180°</p> <p>19.3</p> 	<p>23.</p>  <p>😊 = 8 8 8 8 !</p>	<p>24.</p> 	

Das Montageset ist am Inneren des Karton befestigt!
 The assembly set is attached to the inside of the carton!
 Le kit de montage est fixé à l'intérieur du carton!
 Il materiale per il montaggio è posizionato all'interno della scatola fissato con il nastro adesivo!
 El material de montaje se coloca dentro de la caja fijado con cinta adhesiva!

Note: The lock can be stuck in directly.
 Note: If you want to connect the similar garbage bin, please use the part Z
 Note: Please keep the hinge vertical when installing it