















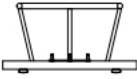



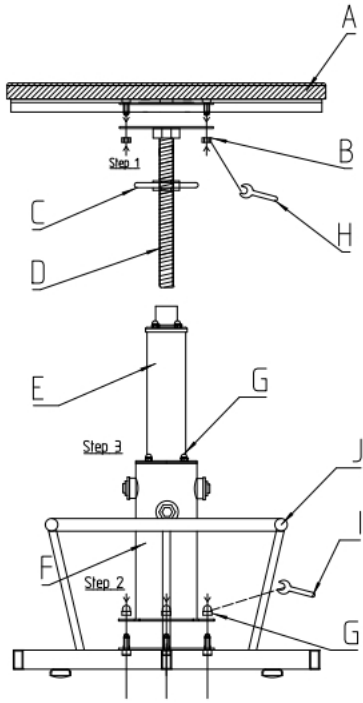

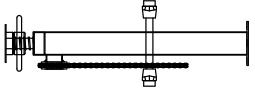
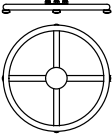
<p>Ax1</p> 	<p>Bx4</p>  <p>M8</p>	<p>Cx1</p> 	<p>Ex1</p> 	<p>Fx1</p> 	<p>Gx8</p>  <p>M8</p>	<p>Jx1</p> 
		<p>Dx1</p> 			<p>Hx1</p>  <p>12mm</p>	<p>Ix1</p>  <p>14mm</p>

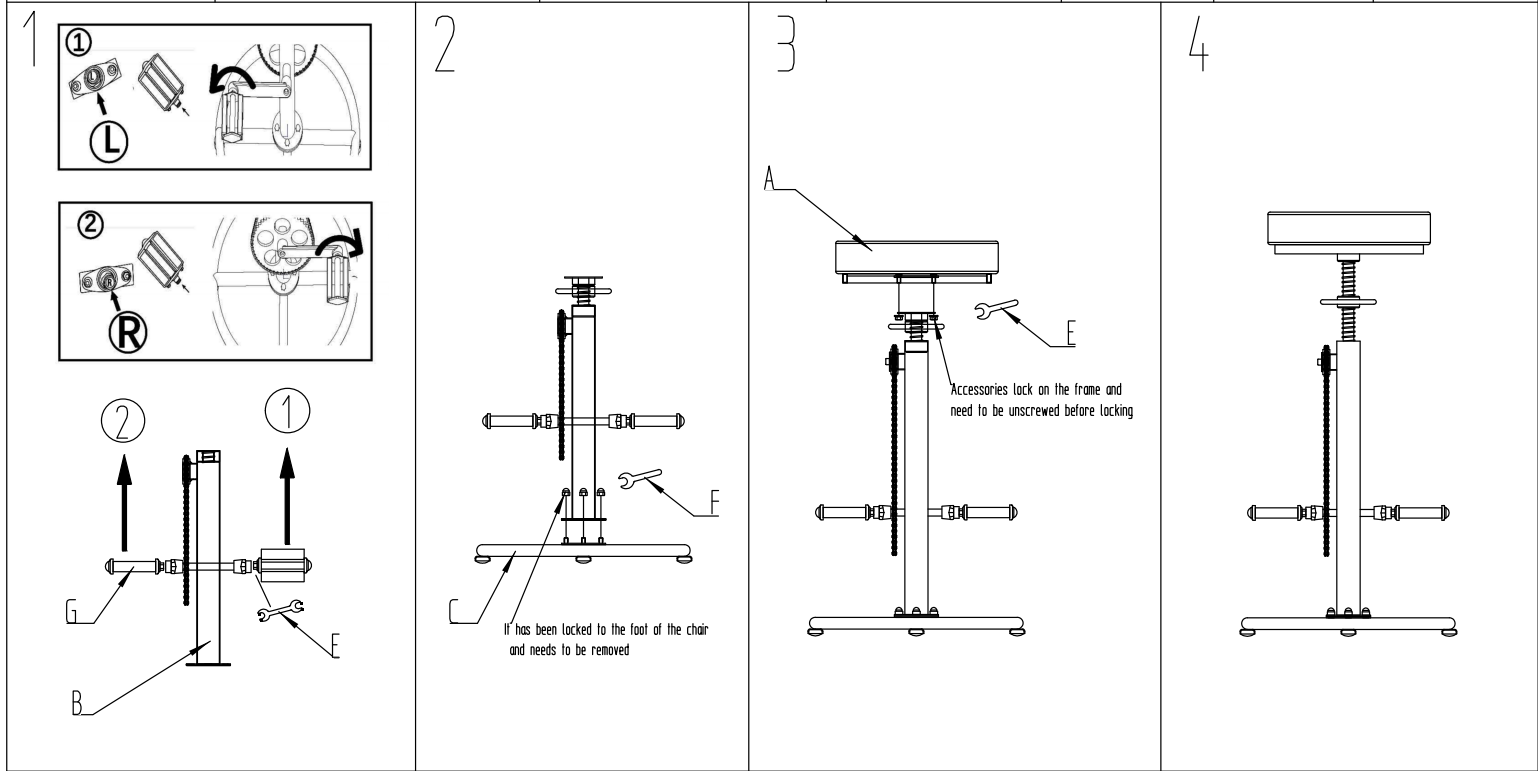
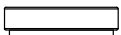
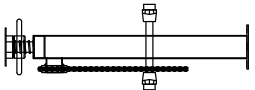
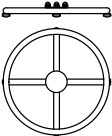

Ax1 	Bx1 	Cx1 	Dx2  L*1. R*1	Ex1  12mm	Fx1  14mm	 5mm
---	--	--	--	--	--	--



Ax1 	Bx1 	Cx1 	Dx2  L*1. R*1	Ex1  12mm	Fx1  14mm	 5mm
---	--	--	--	--	--	--

