

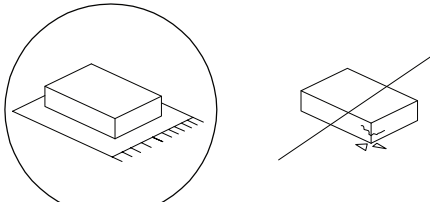

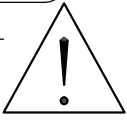

		30'
		
		2

A	B	C	D	E
				 M10 x 13
x1	x1	x1	x1	x4

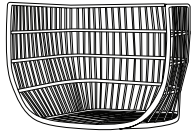

F	G	H	I	J
 M10 x 27				
x4	x8	x1	x1	x2

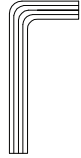
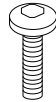
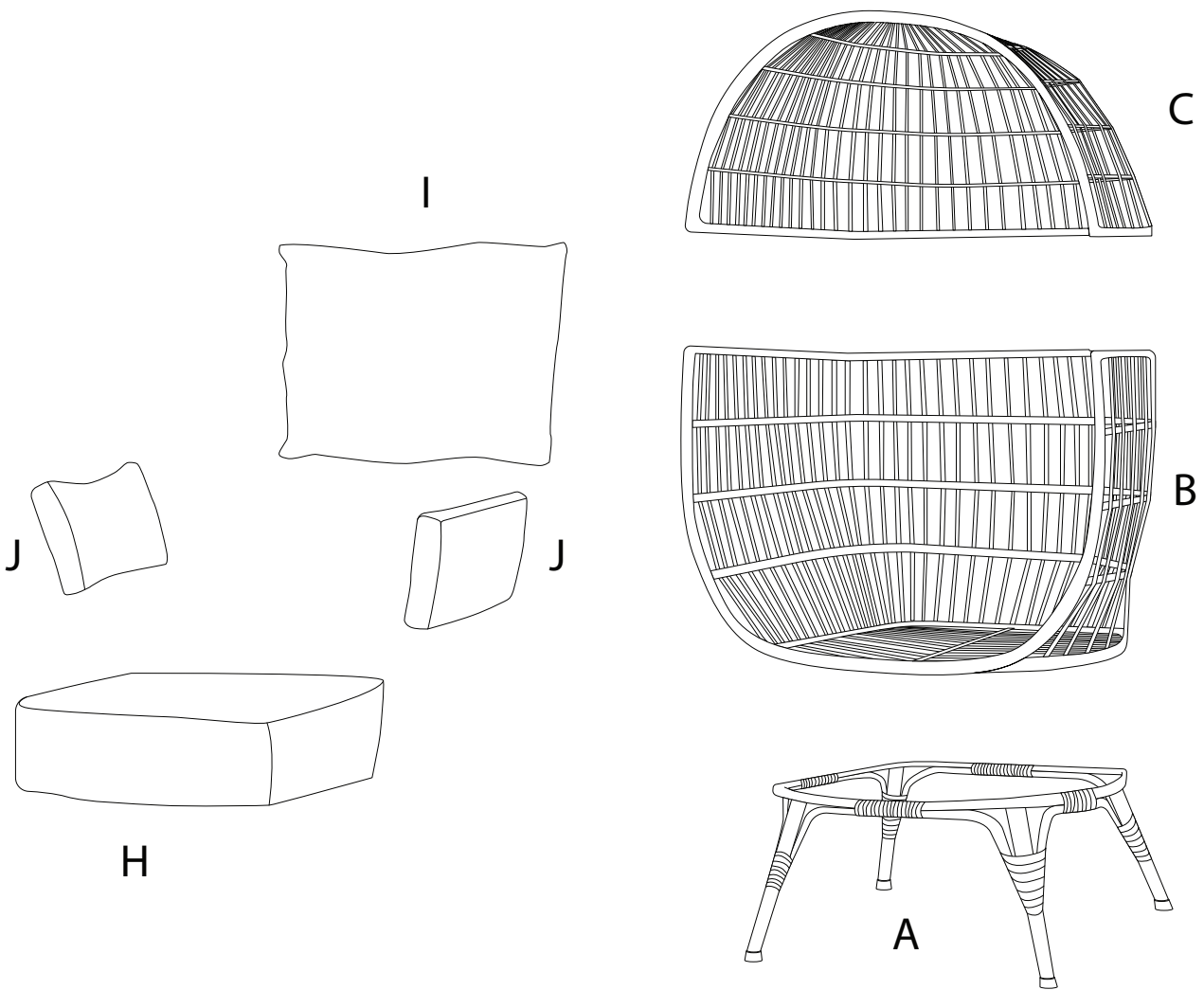
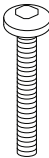
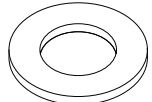
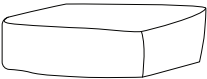
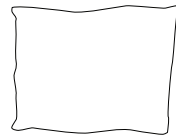
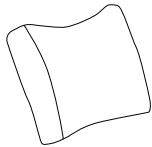
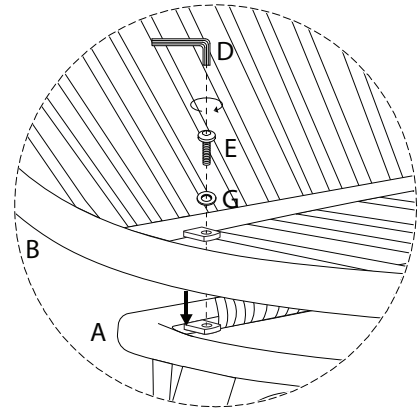
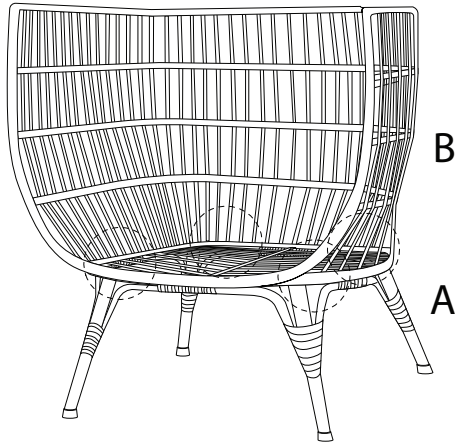
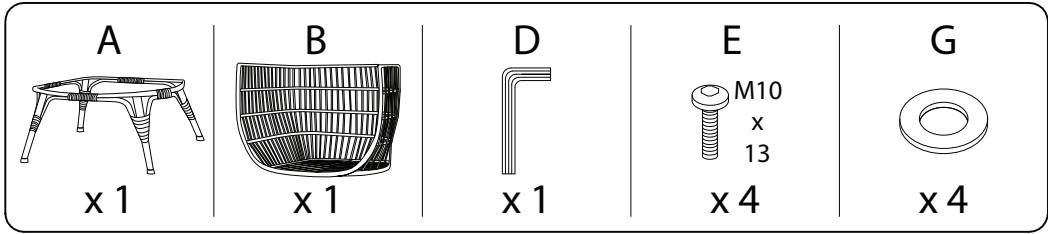
1



2

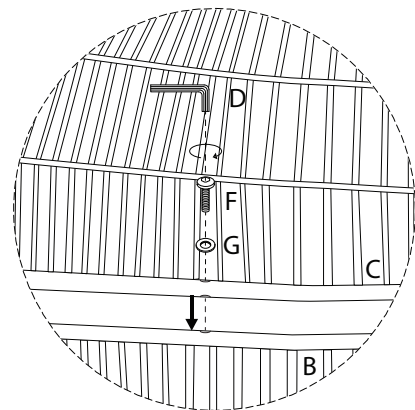
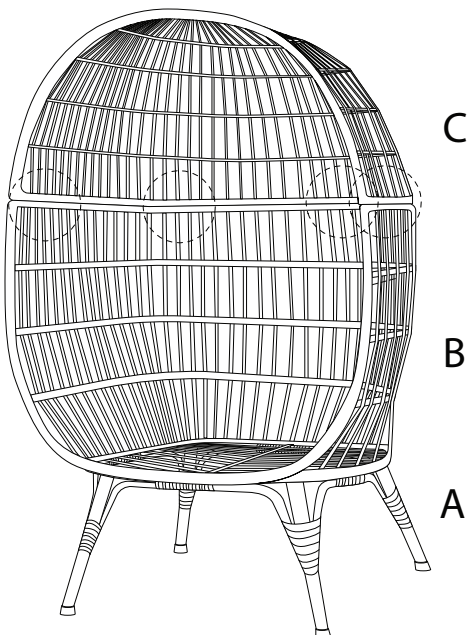
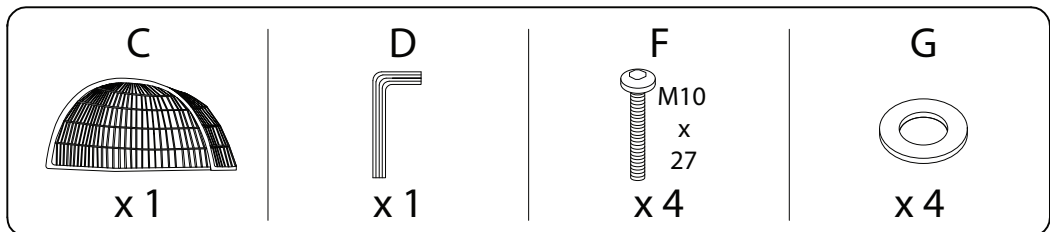

3

H

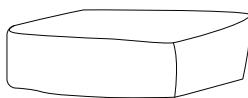

x 1

H

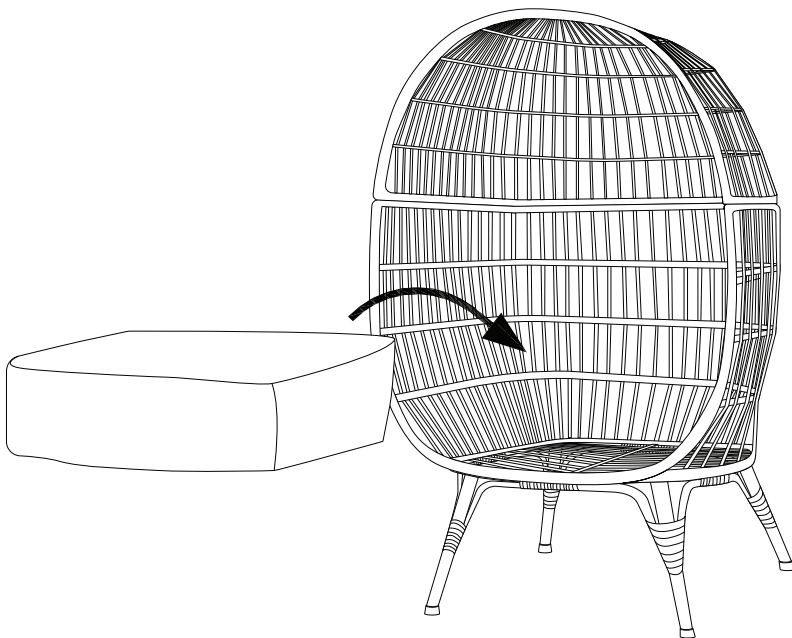

4

I

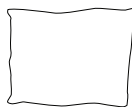

x 1

I

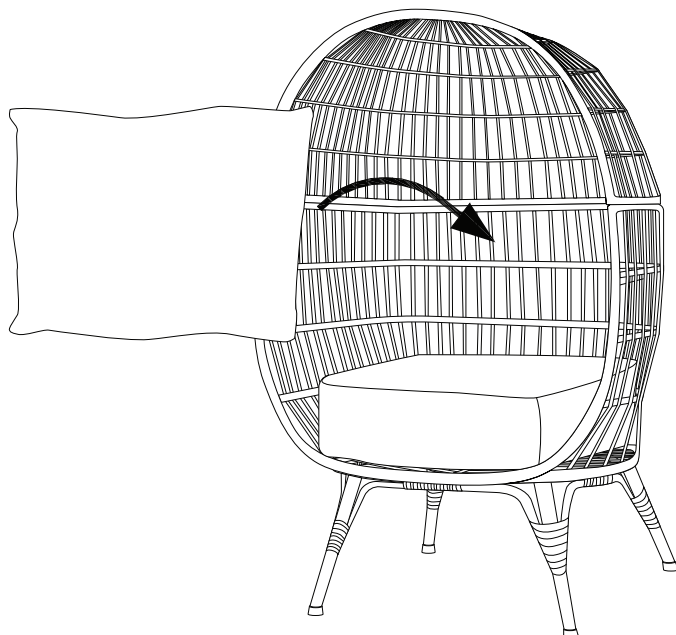

5

J

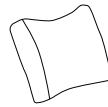

x 2

