

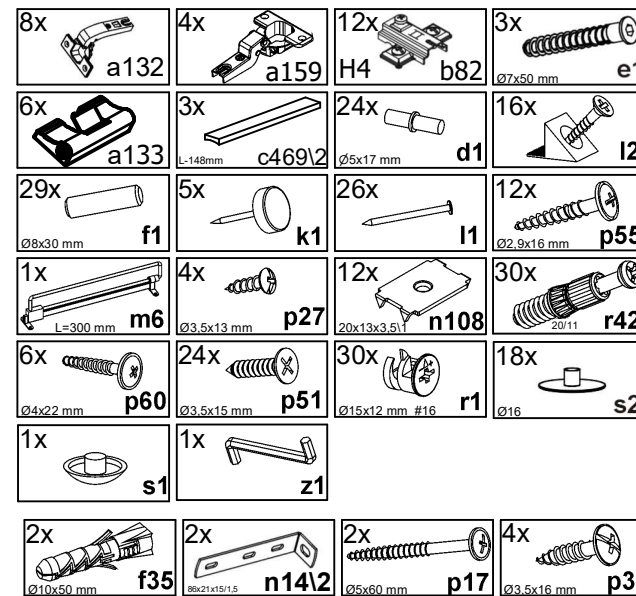

90min

A	B	C1	C2	C3	D
1	M222-0010	1884	316	16	3/3
2	M222-0012	1884	316	16	3/3
3	M222-0013	764	316	16	3/3
4	M222-1017	1950	364	16	2/3
5	M222-1018	1950	364	16	2/3
6	M222-1019	1874	344	16	2/3
7	M222-2007	1121	400	32	1/3
8.1	M222-3006-BI	375	334	16	1/3
8.2	M222-3006-DCM	375	334	16	1/3
9	M222-3020	1087	344	16	1/3
10	M222-3021	694	334	16	1/3
11	M222-3022	695	344	16	1/3
12	M222-3023	376	344	16	1/3
13	M222-5002	60	80	19	2/3
14	M222-5010	1950	80	19	2/3
15	M222-5011	1950	80	19	2/3
16	M222-9002	1893	390	2,5	2/3
17	M222-9306	1893	707	2,5	2/3

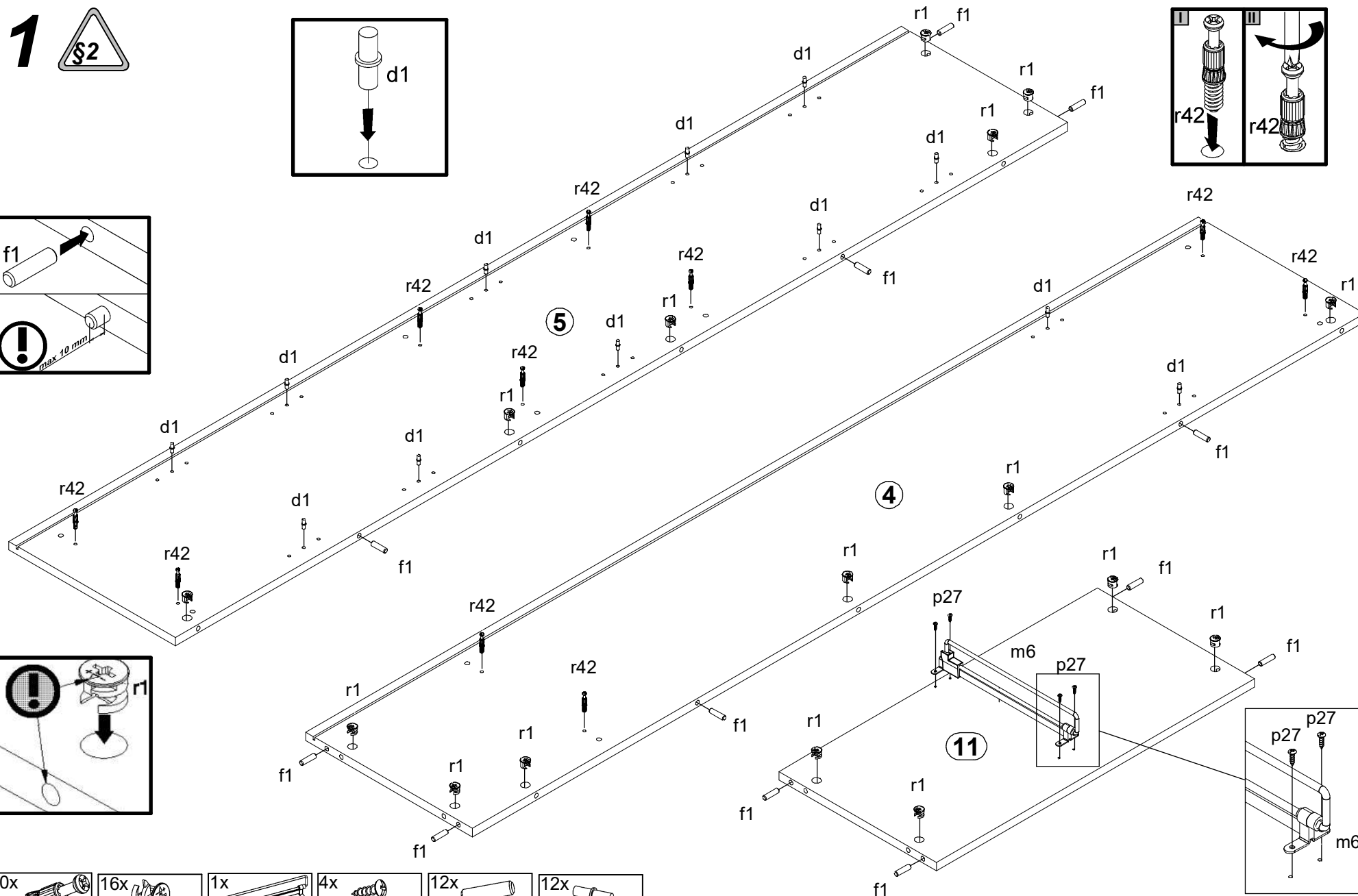
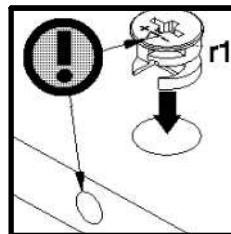
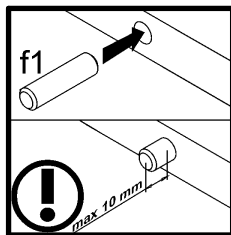
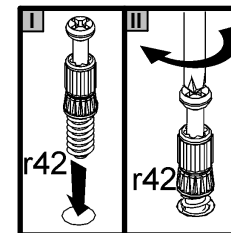
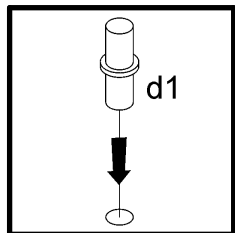

1 

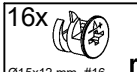
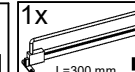
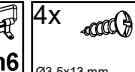
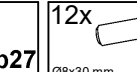
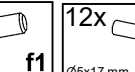

- 10x  r42
- 16x  r1
- 1x  m6 L=300 mm
- 4x  p27 Ø3,5x13 mm
- 12x  f1 Ø8x30 mm
- 12x  d1 Ø5x17 mm

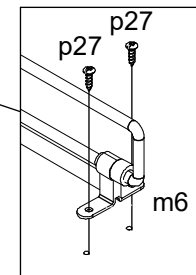

1

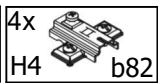
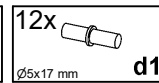
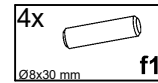
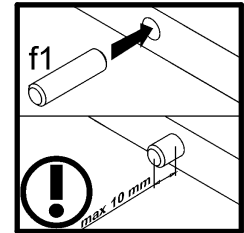
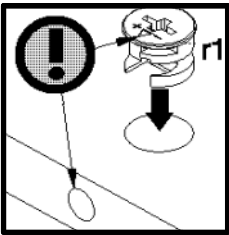
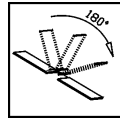
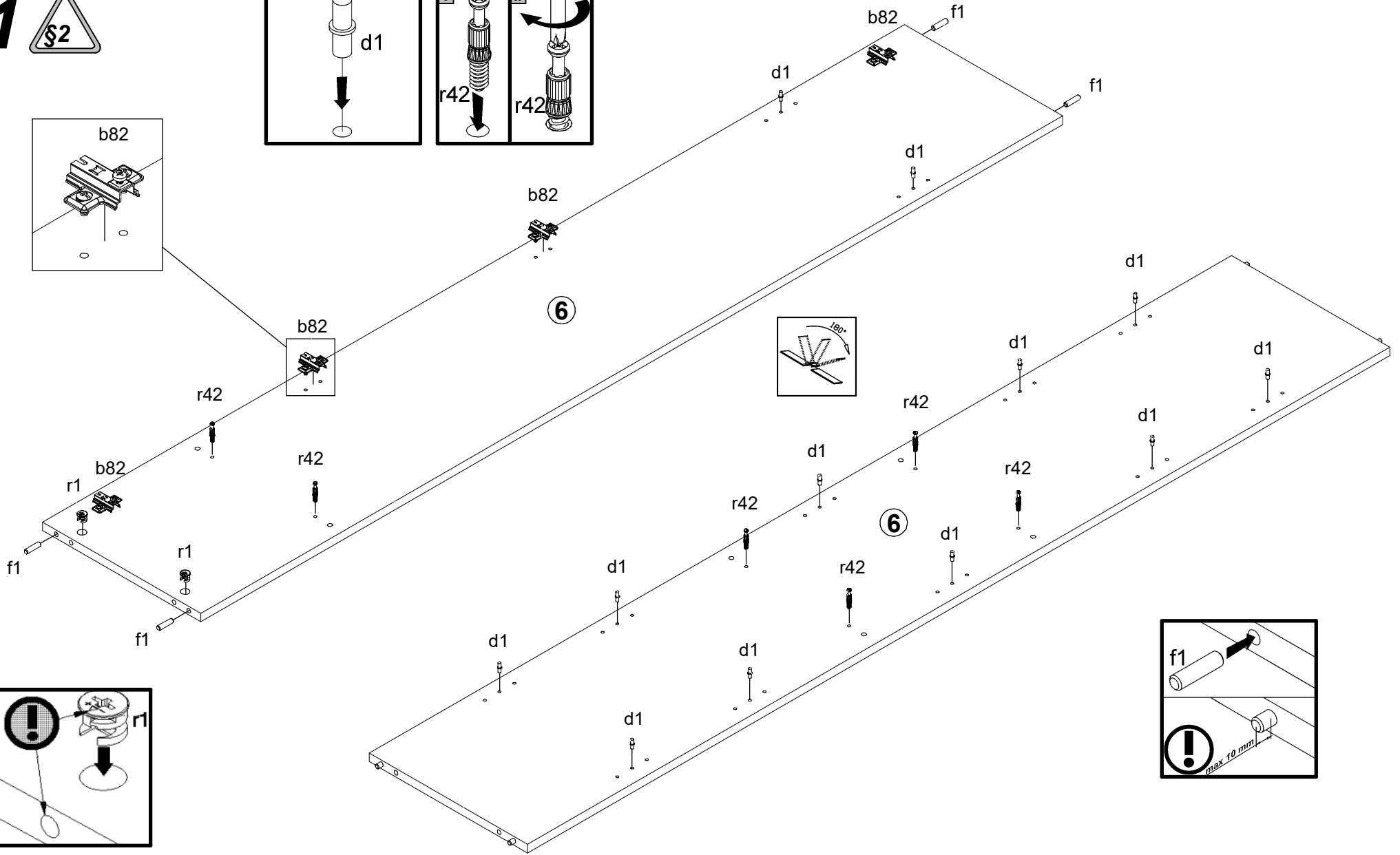
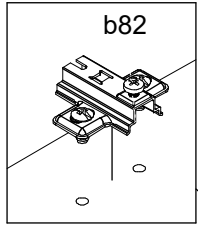
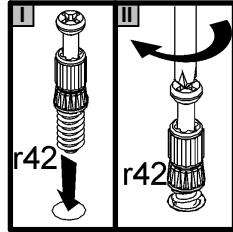
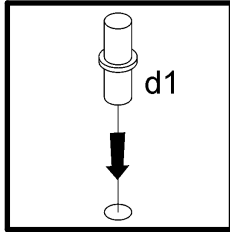

1

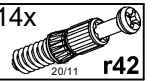
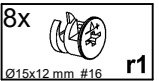
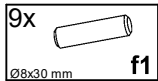
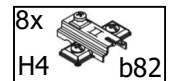
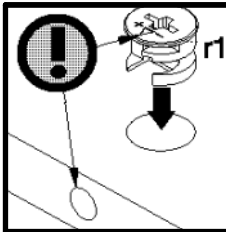
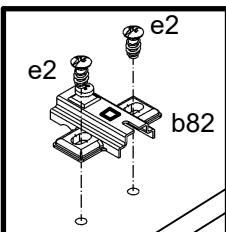
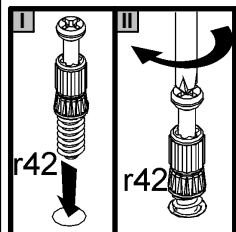
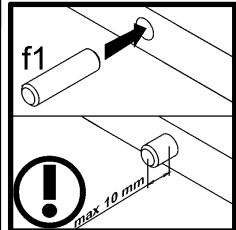
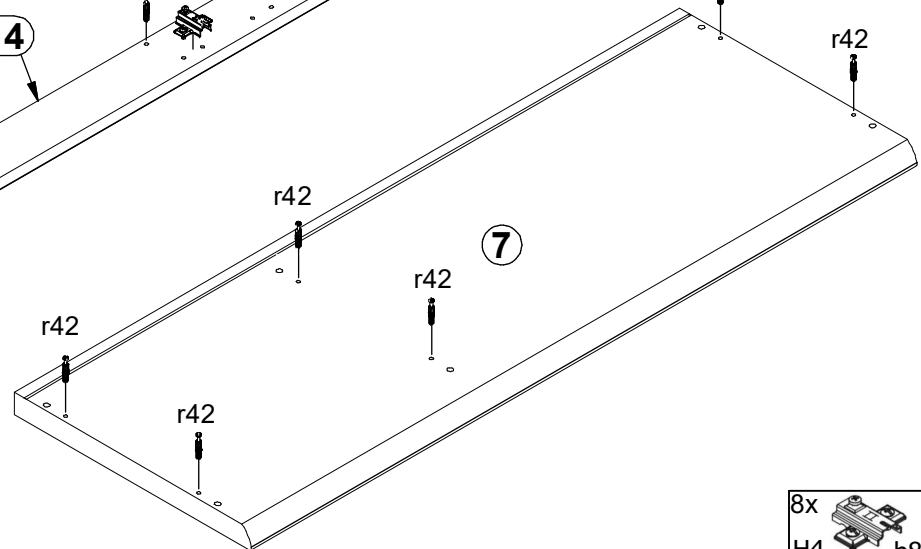
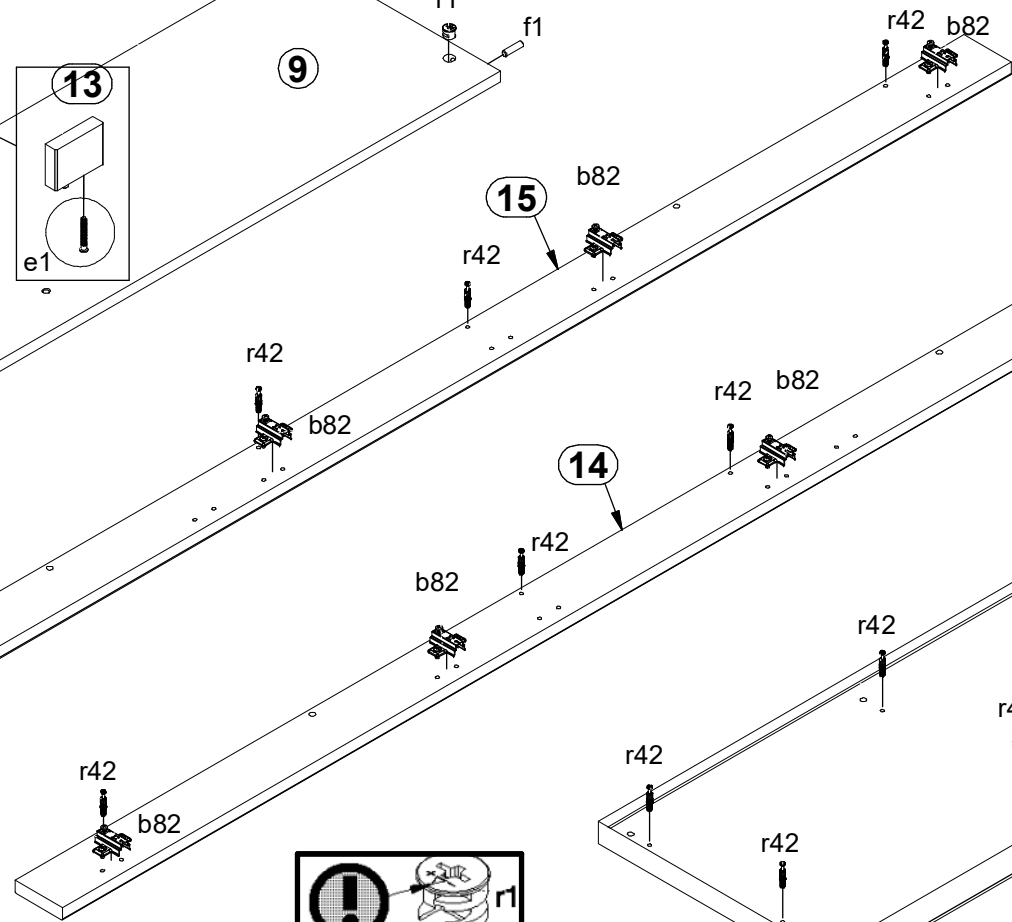
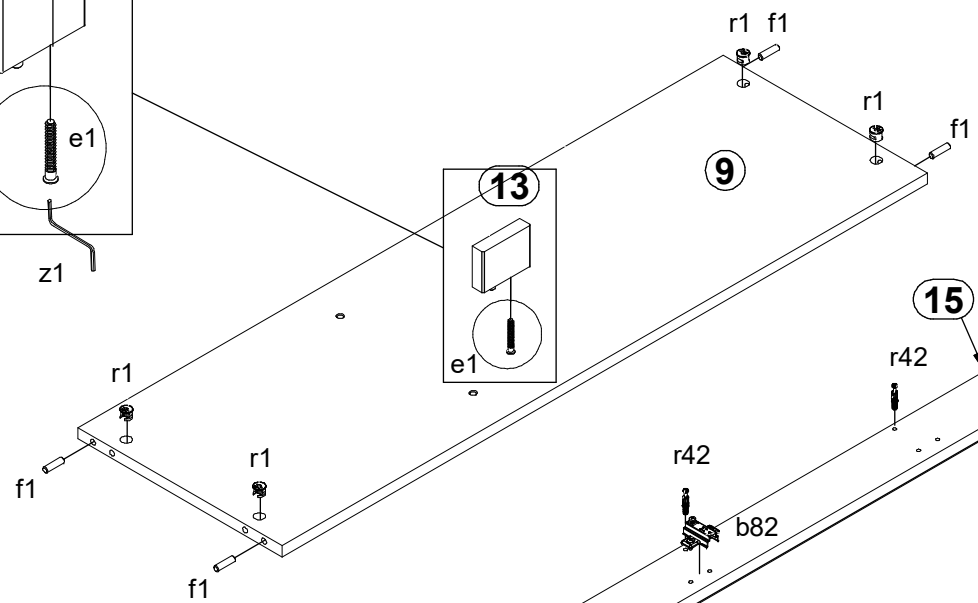
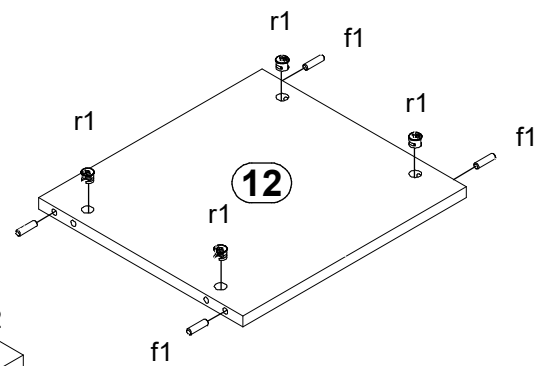
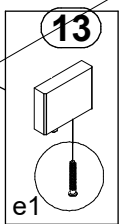
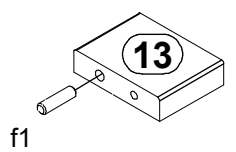
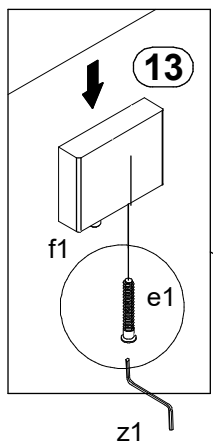



2

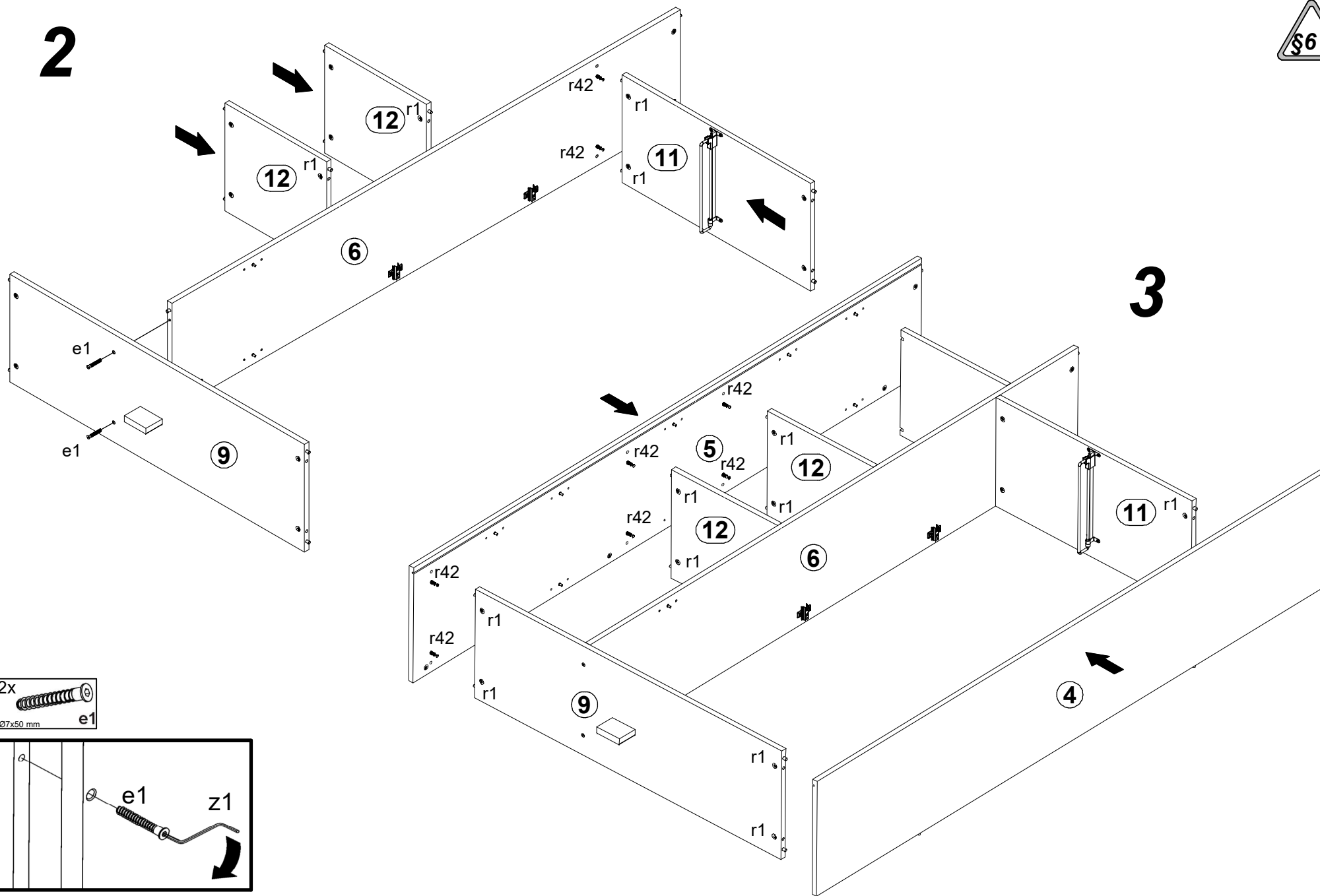

3

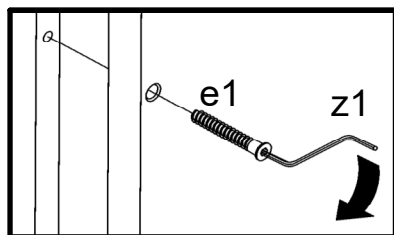
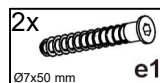

4

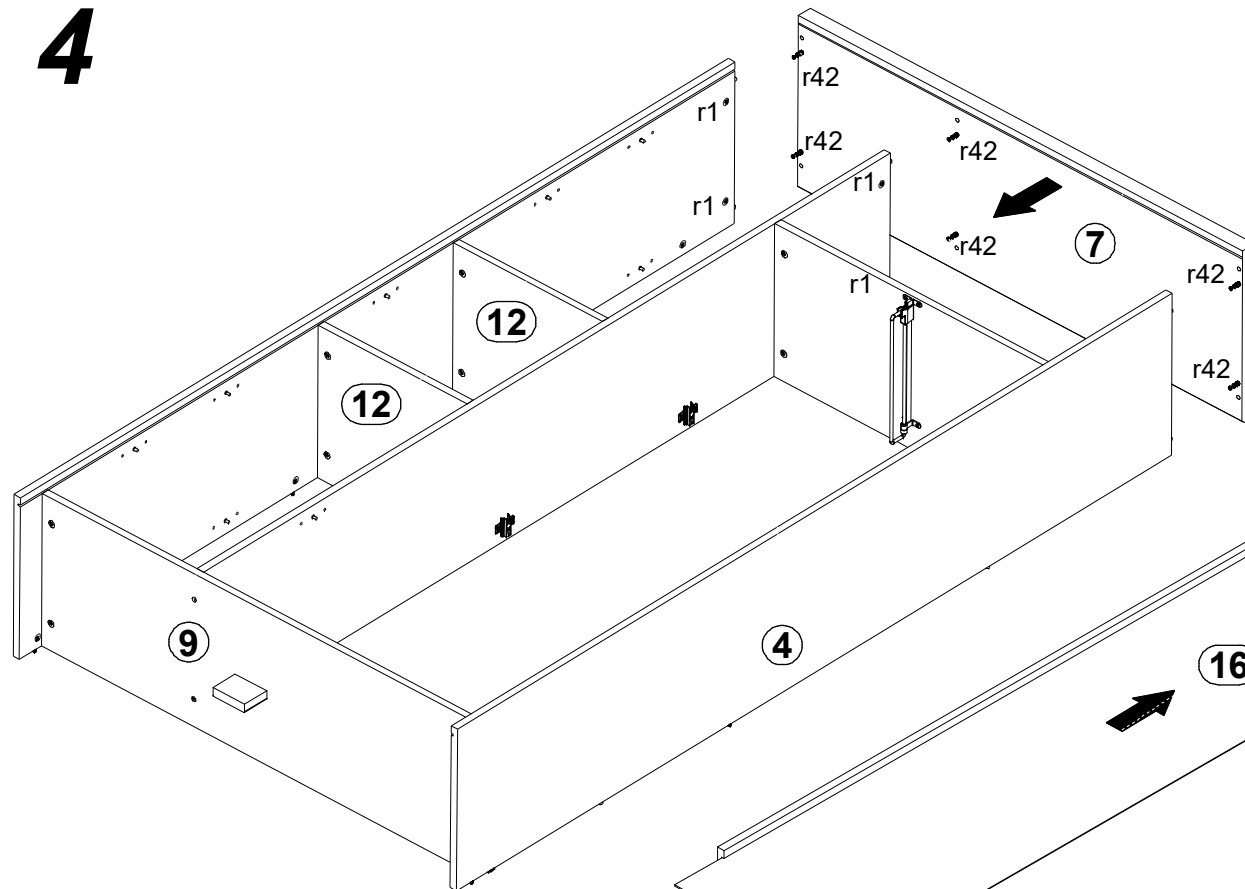

5

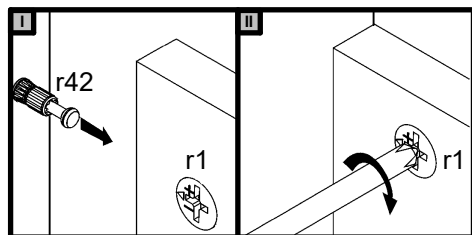
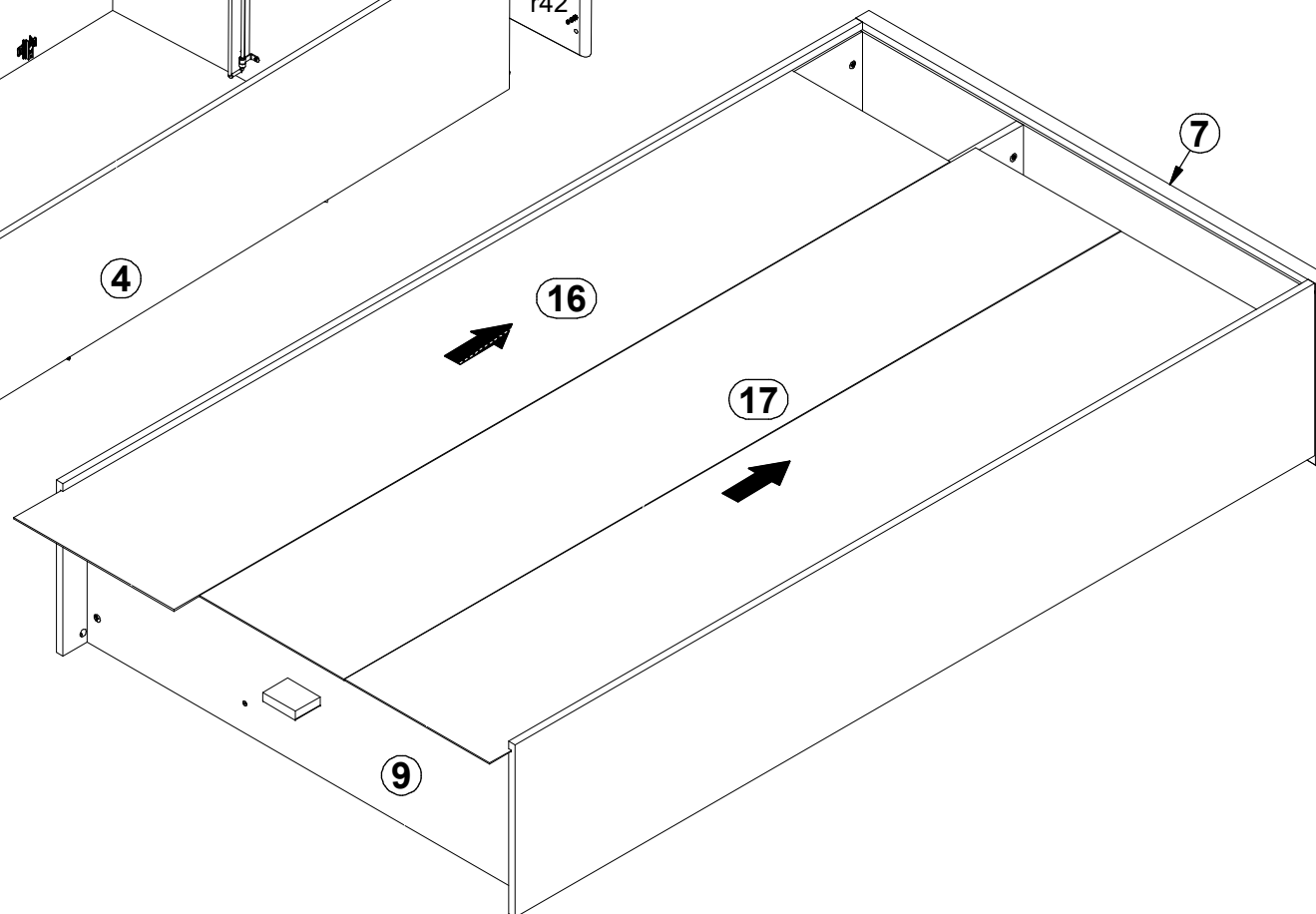

# 6

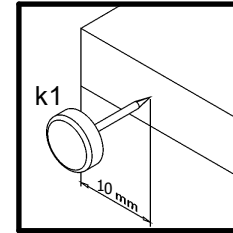
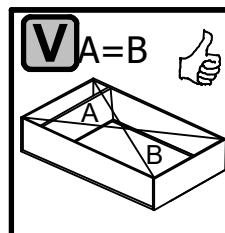
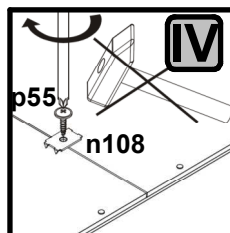
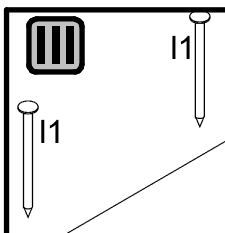
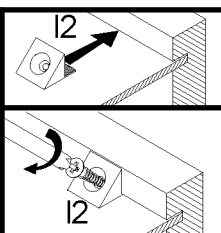
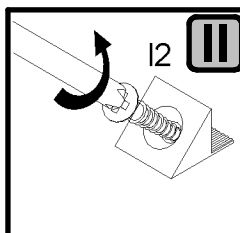
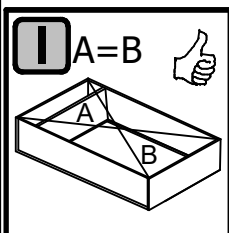
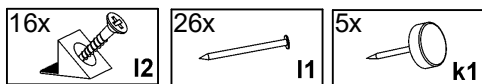
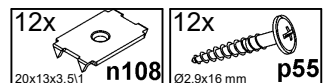
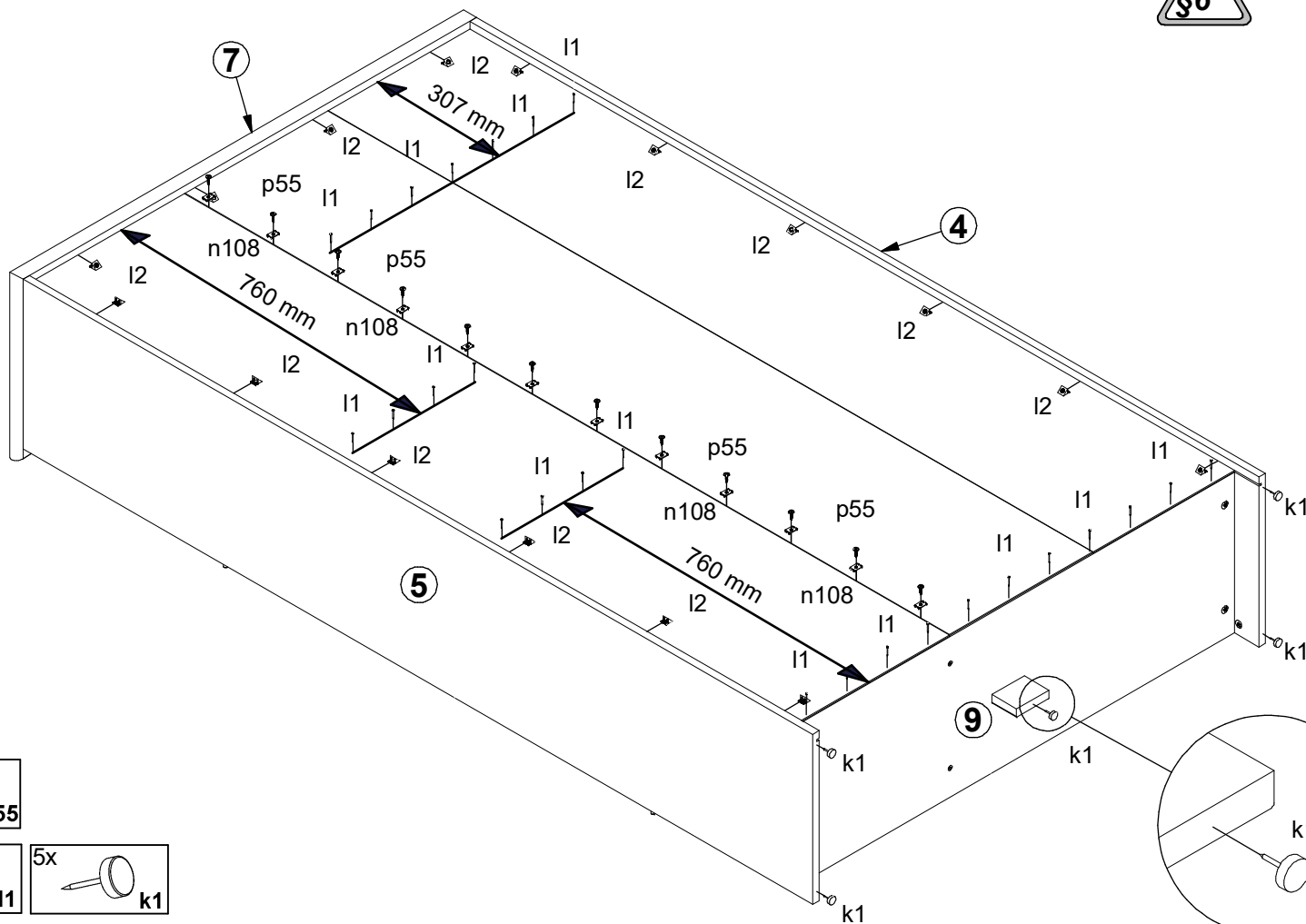



7

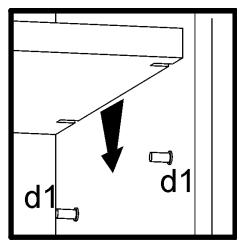
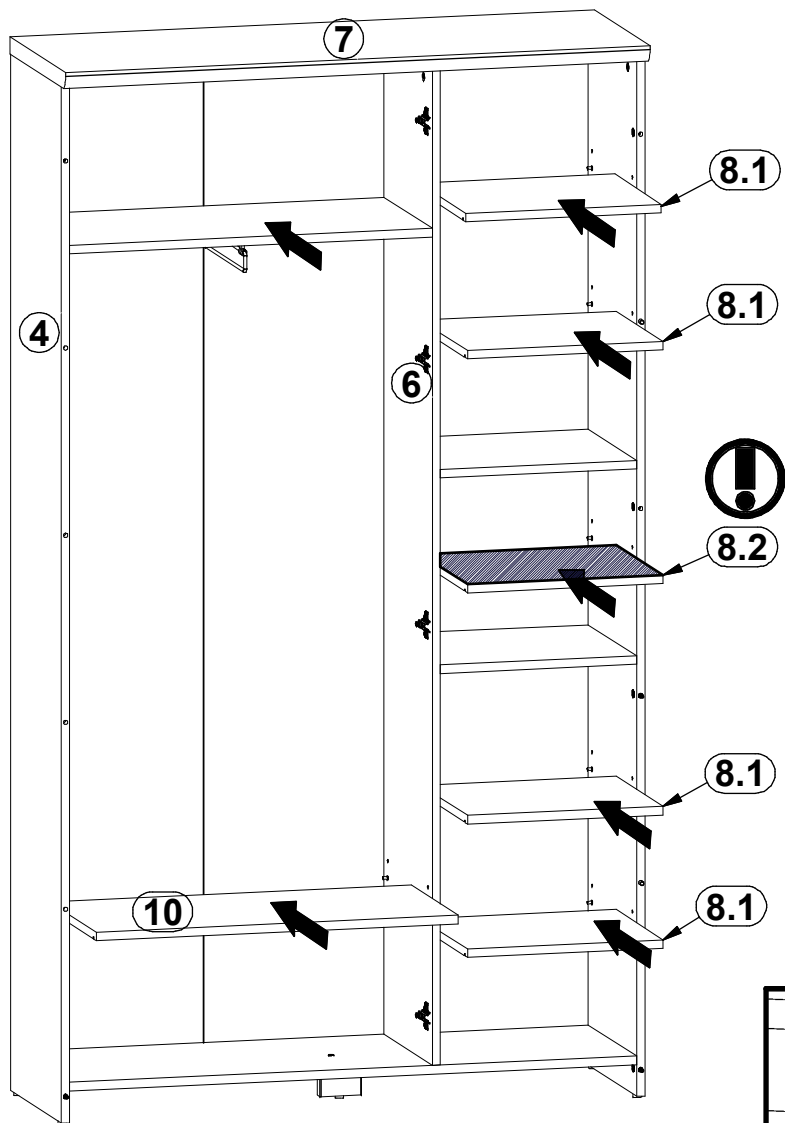

8

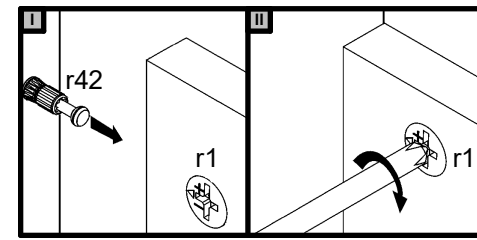
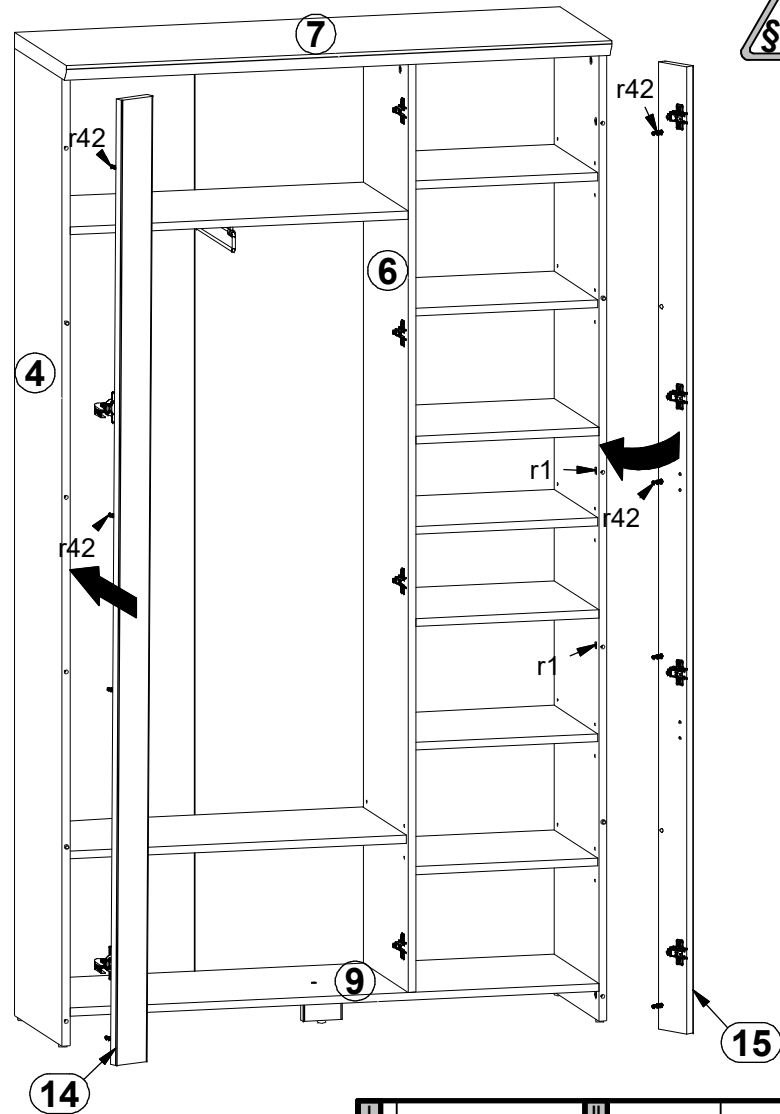

# 9

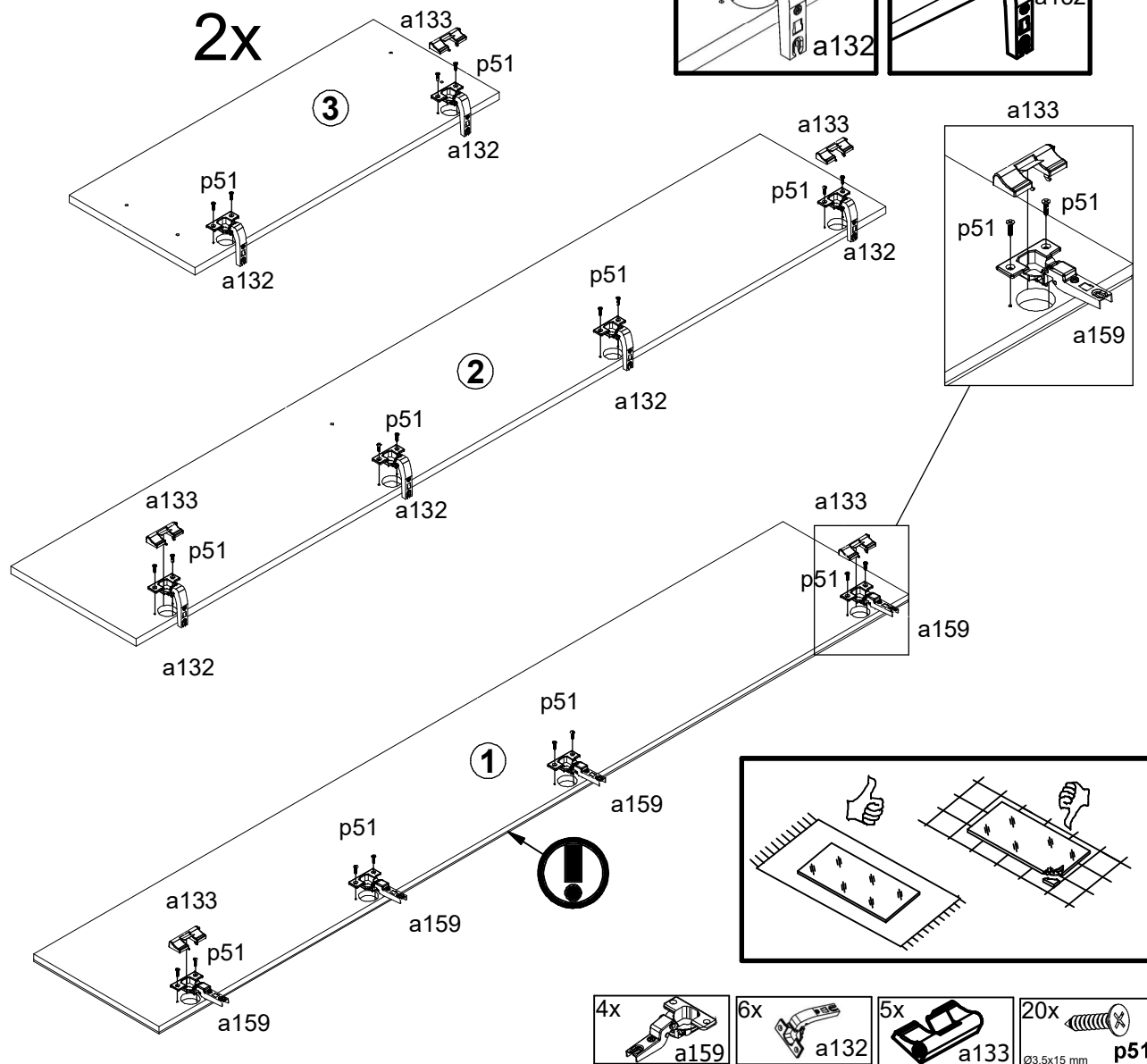

# 10

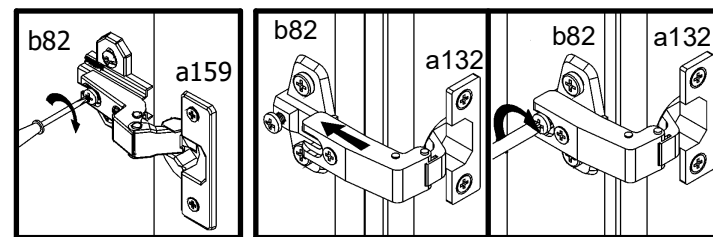
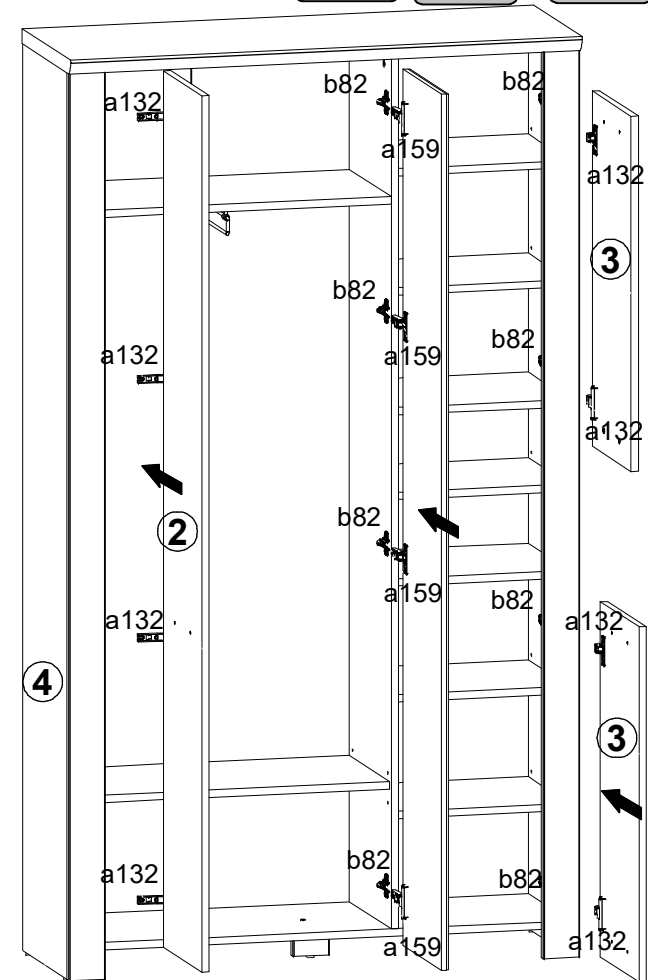

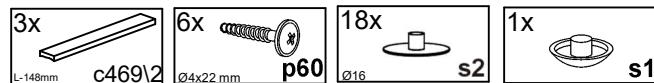

# 11

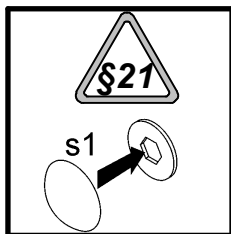
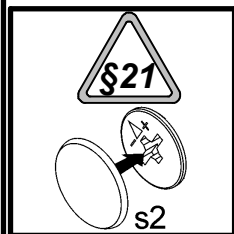
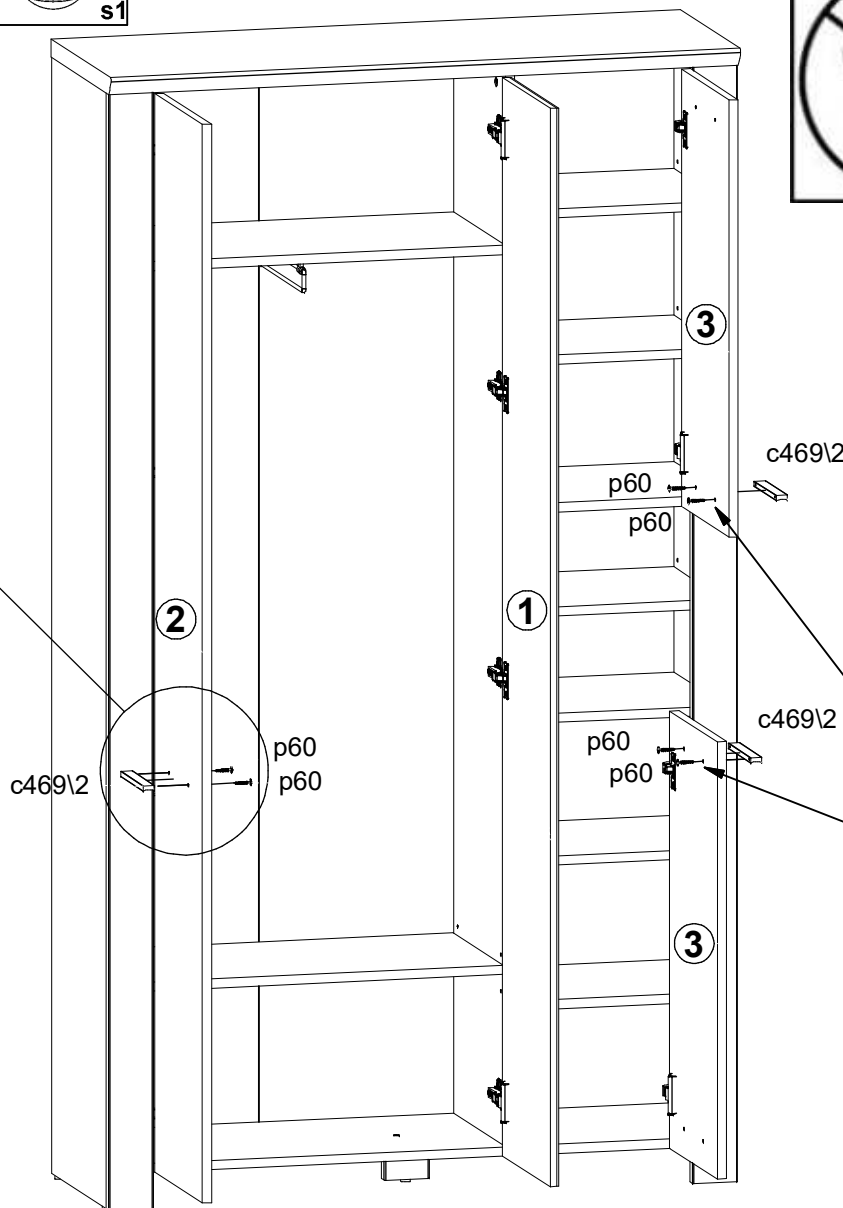
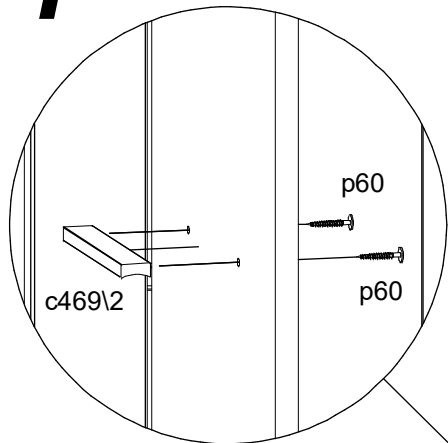
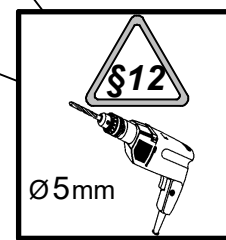
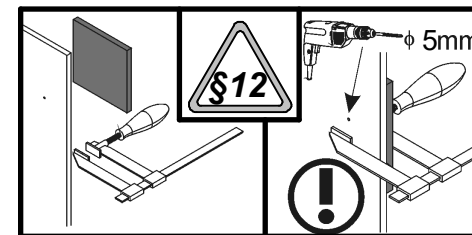

# 12

