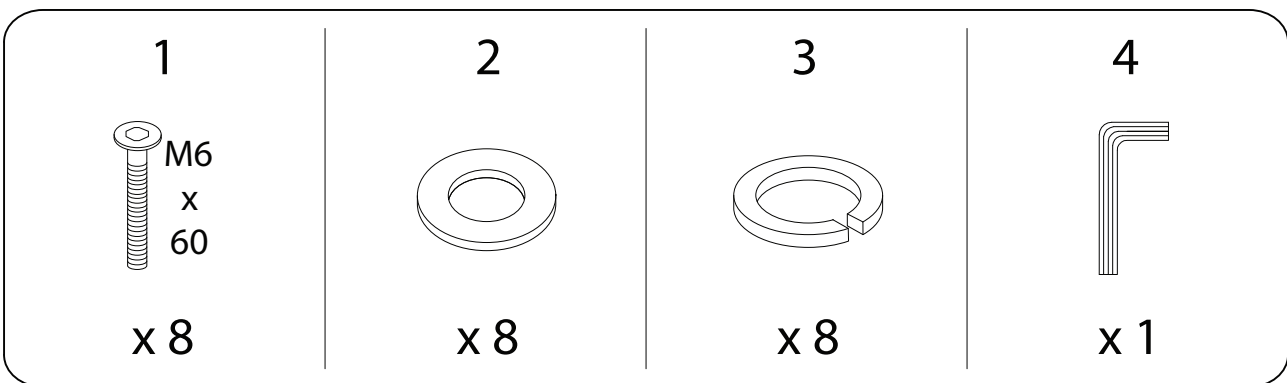
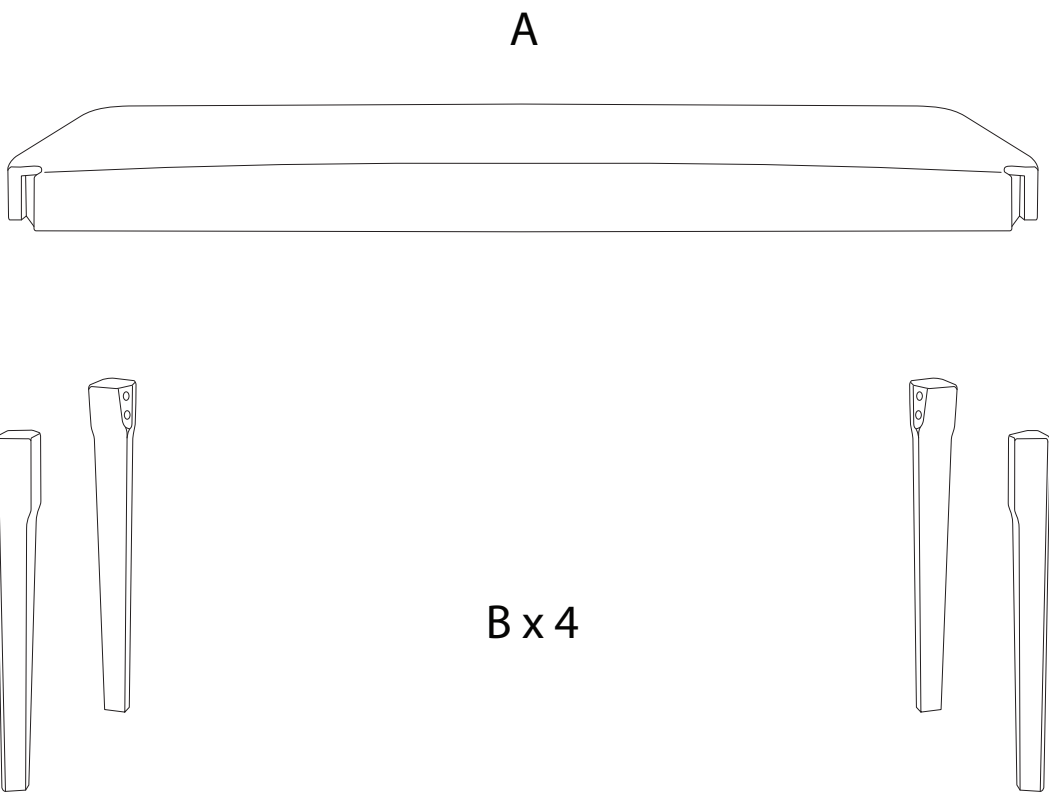
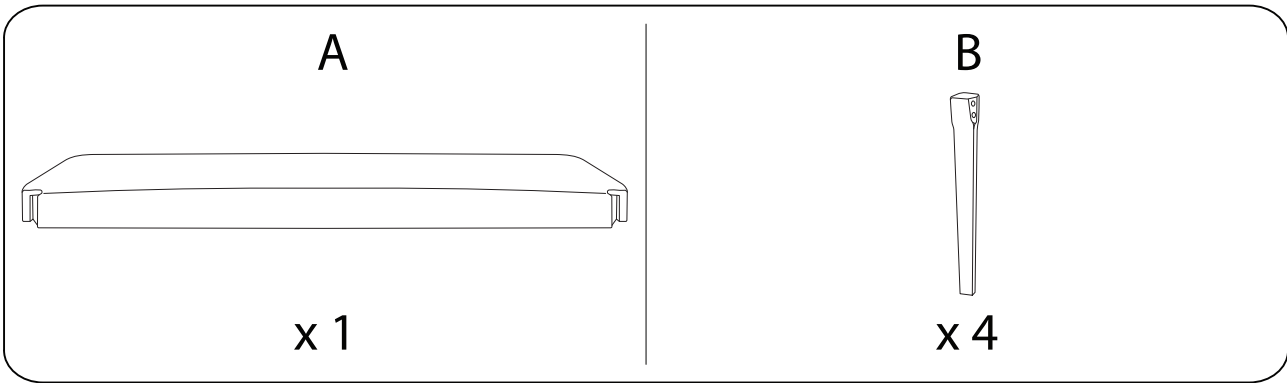
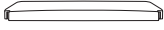

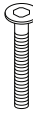

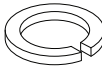



Diagram illustrating assembly instructions and safety warnings:

- Warning 1:** A warning triangle with an exclamation mark is shown next to a box containing an L-shaped bracket and a power drill with a slash through it, indicating that a power drill should not be used for this step.
- Warning 2:** A second warning triangle with an exclamation mark is shown next to a box containing a rectangular block being placed on a surface and a diagram showing a block being secured with a screw.
- Time:** A clock icon is shown with the text "30'" below it, indicating a 30-minute assembly time.
- Personnel:** A person icon is shown with the number "2" below it, indicating that two people are required for assembly.



1

A  x 1	B  x 4	1  M6 x 60 x 8	2  x 8	3  x 8	4  x 1
--	--	---	---	--	--

