

A

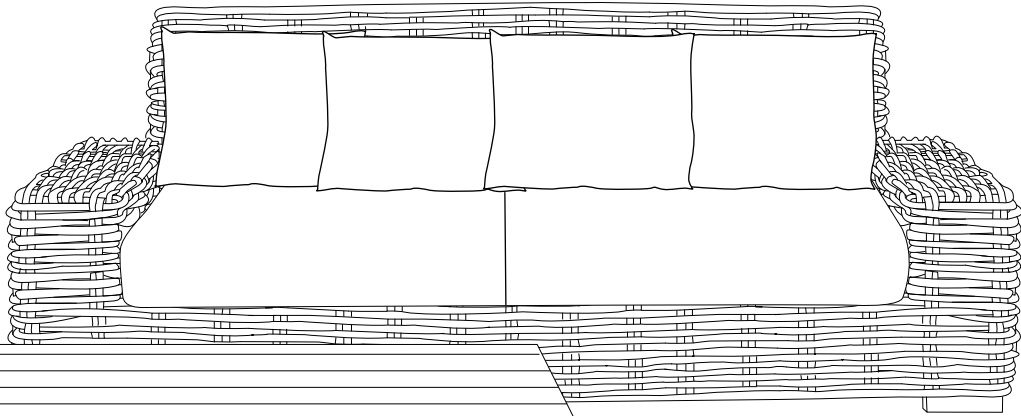

B

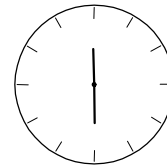
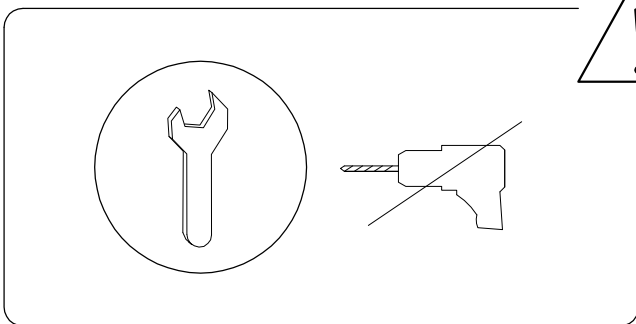
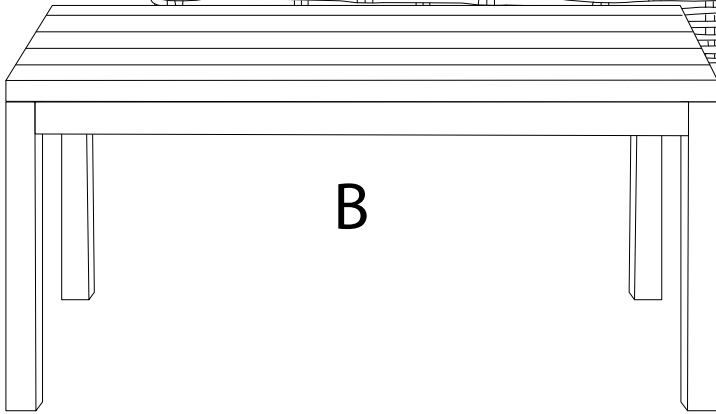

30'

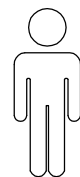
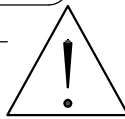
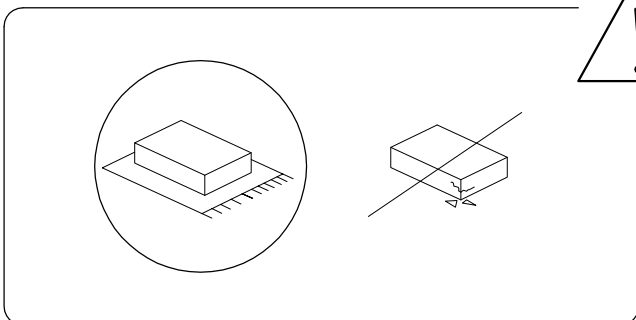

1

A

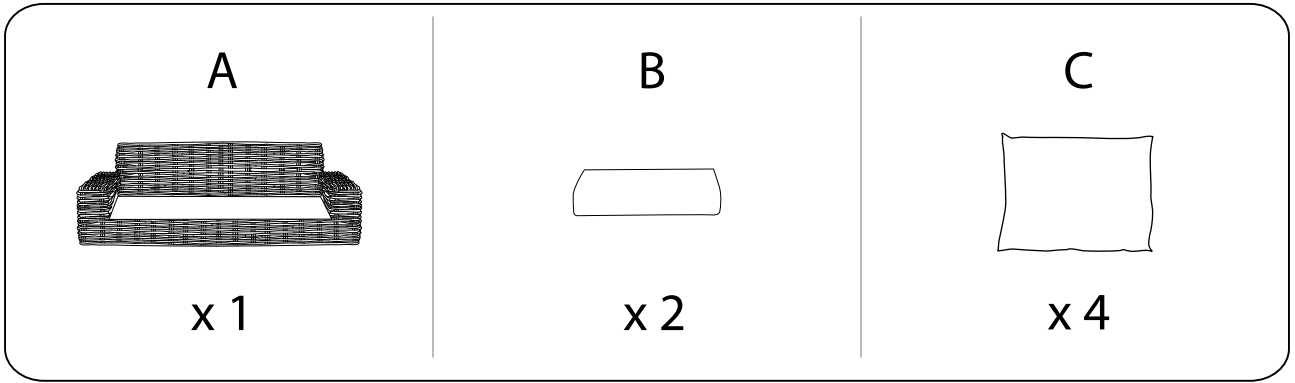

C x 4

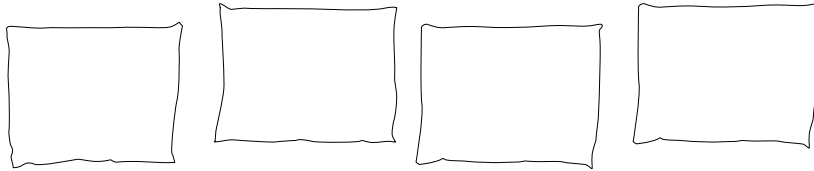

B x 2

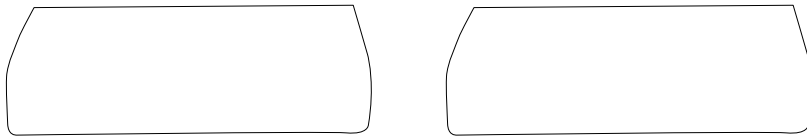

A x 1

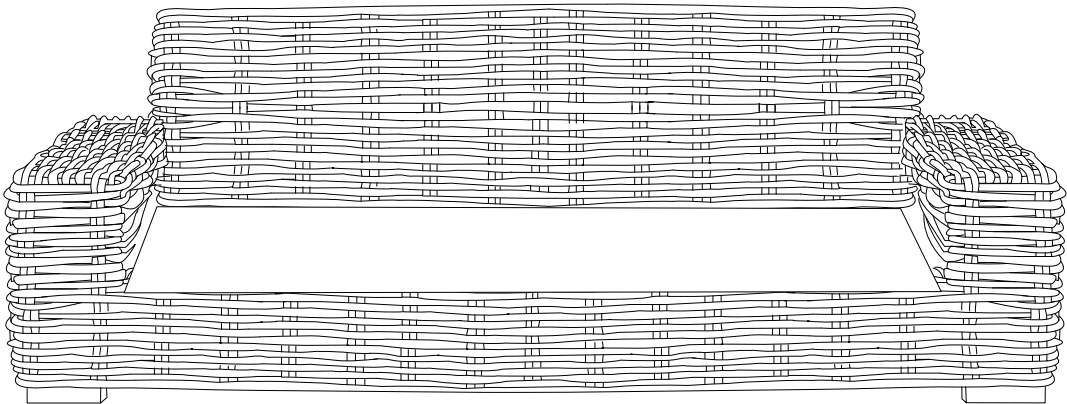

1

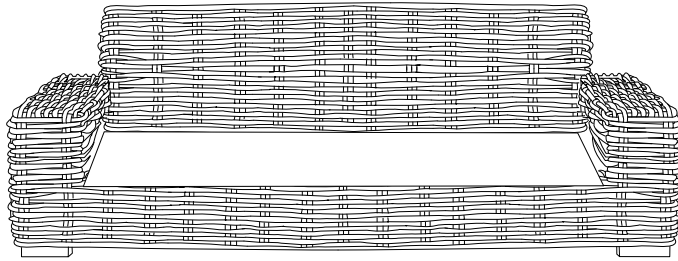
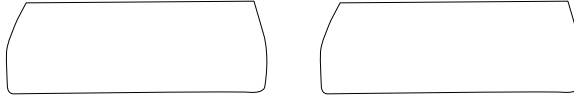
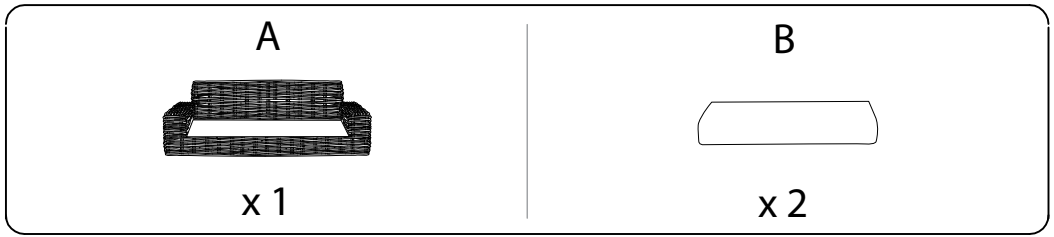

2

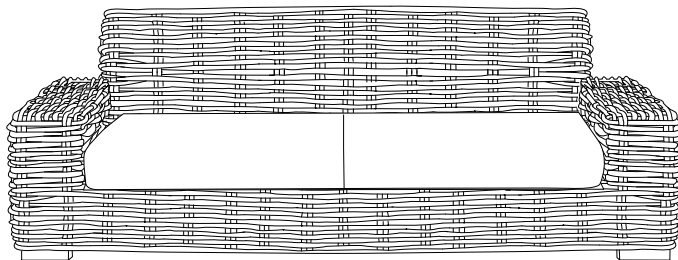
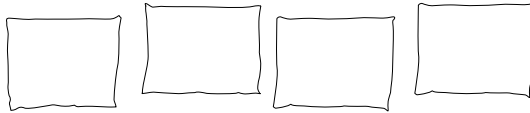
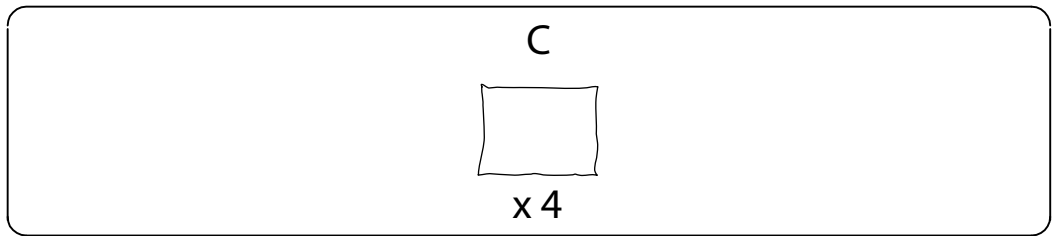

B

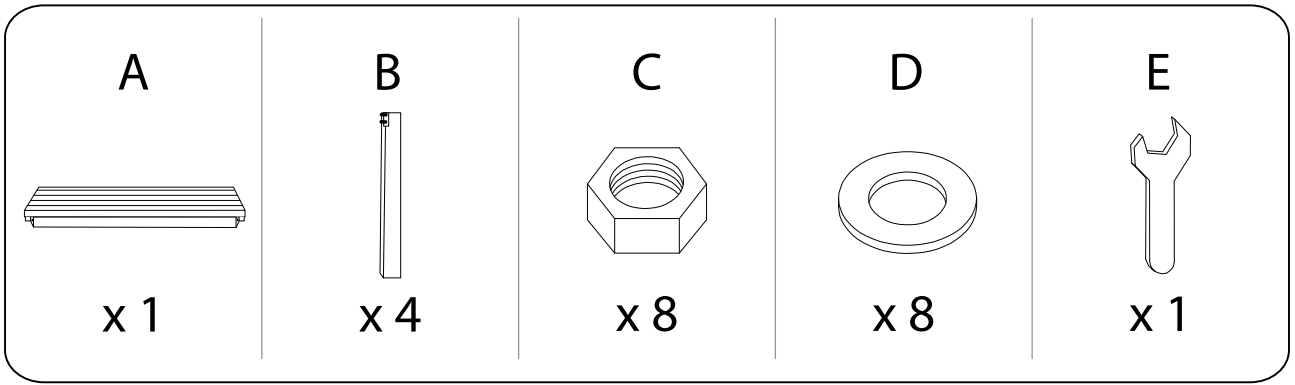

A x 1

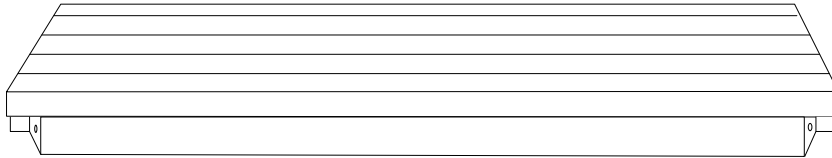

B x 2

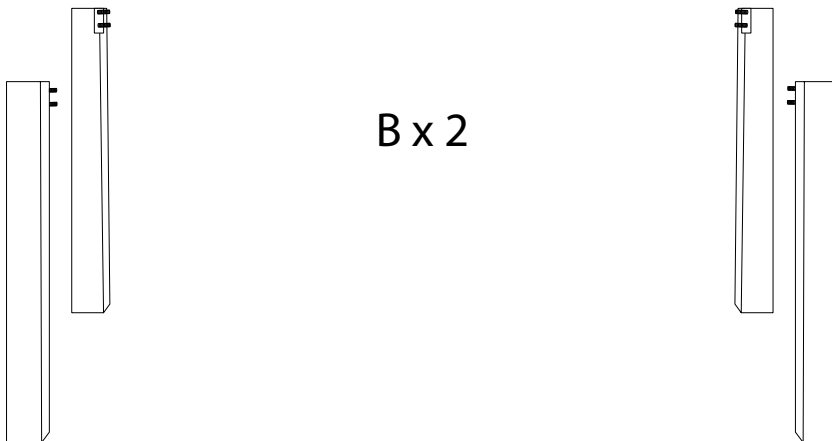

1

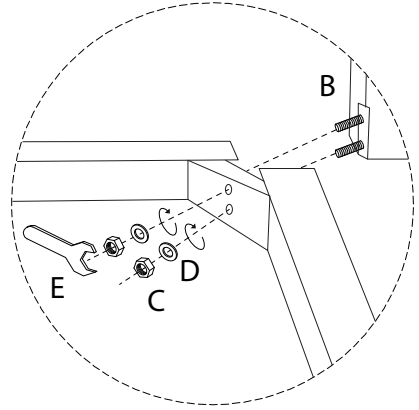
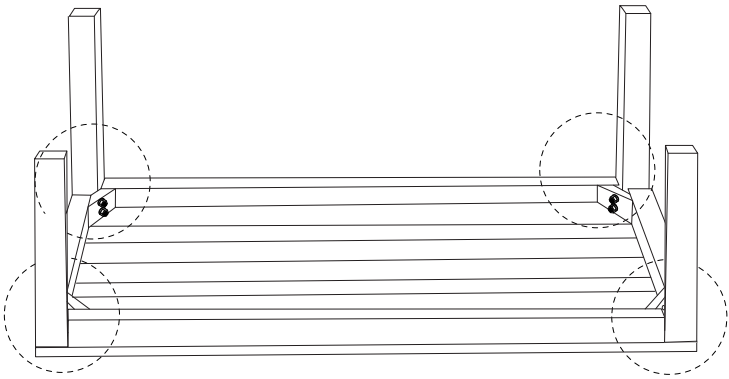
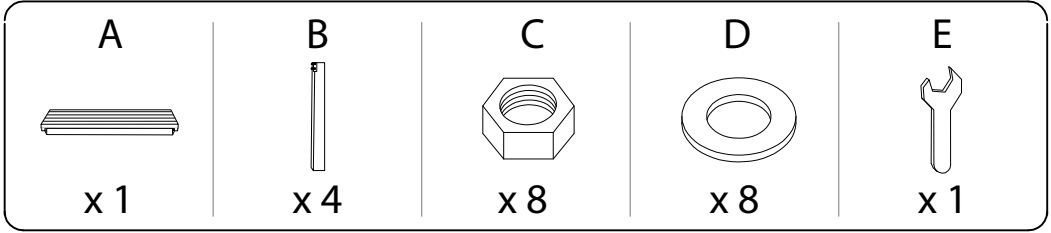

!

