



Assembly instructions for the chair, including safety warnings, tool requirements, and estimated time.

Warning 1: Do not use a power drill. Use an Allen key (shown in a circle) to tighten the screws. 

Warning 2: Do not use a power drill to tighten the screws. Use a screwdriver (shown in a circle) to tighten the screws. 

Estimated Time: 20' 

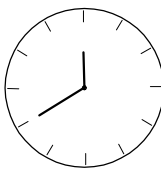
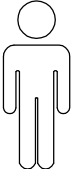
Number of People: 1 

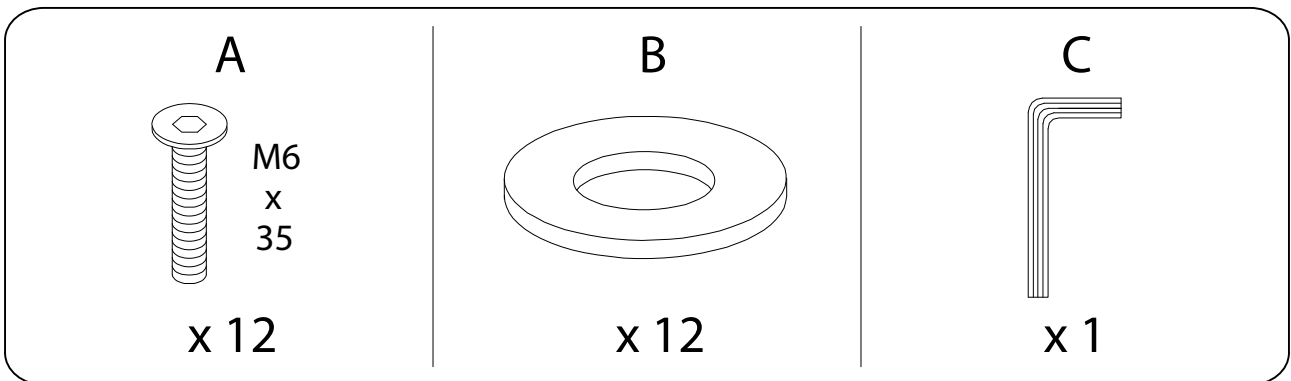
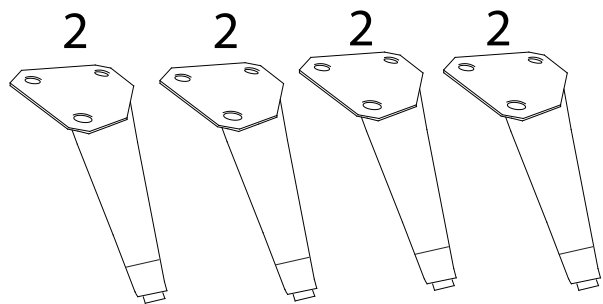
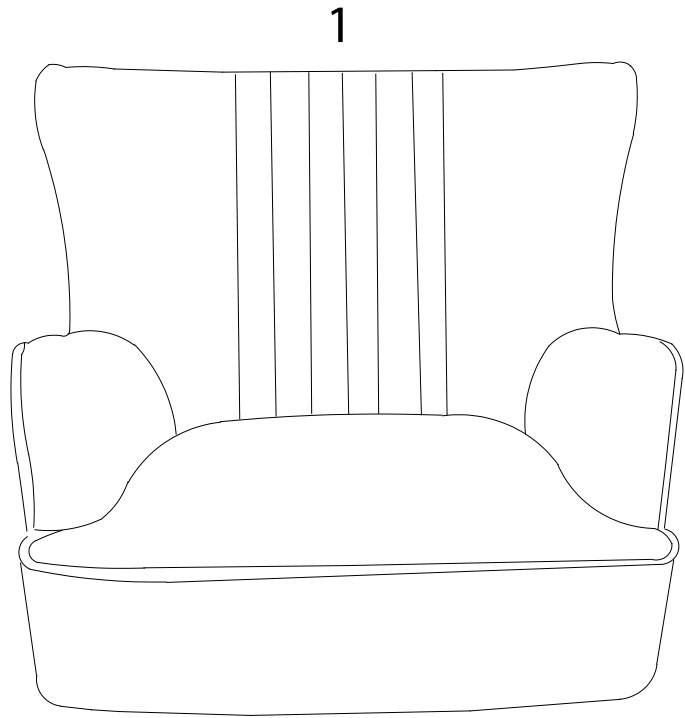
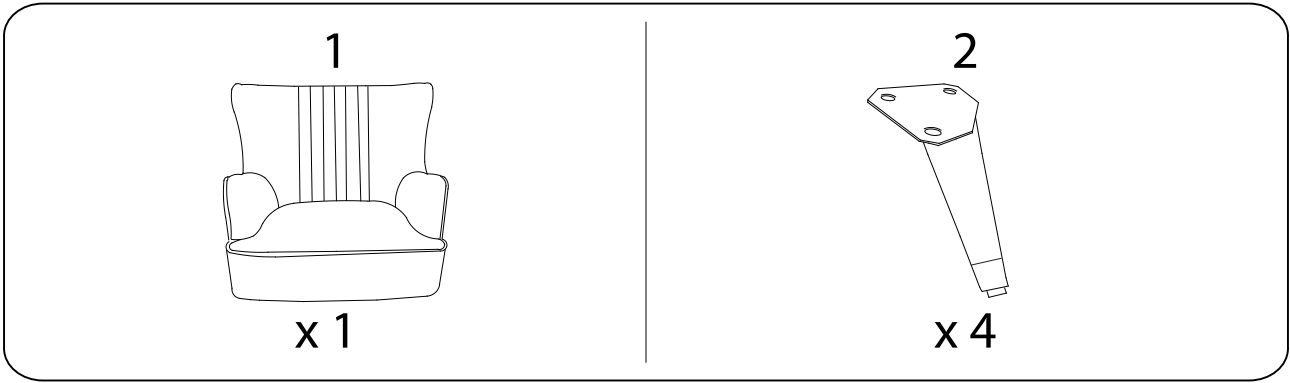

1

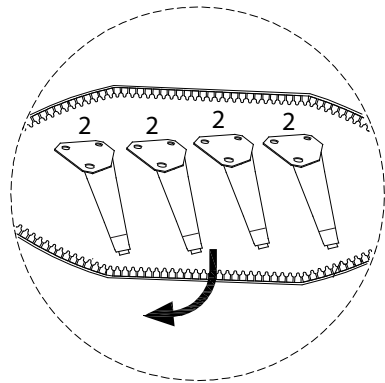
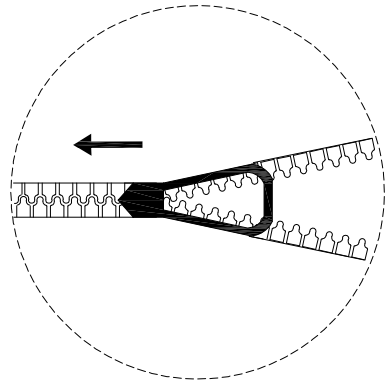
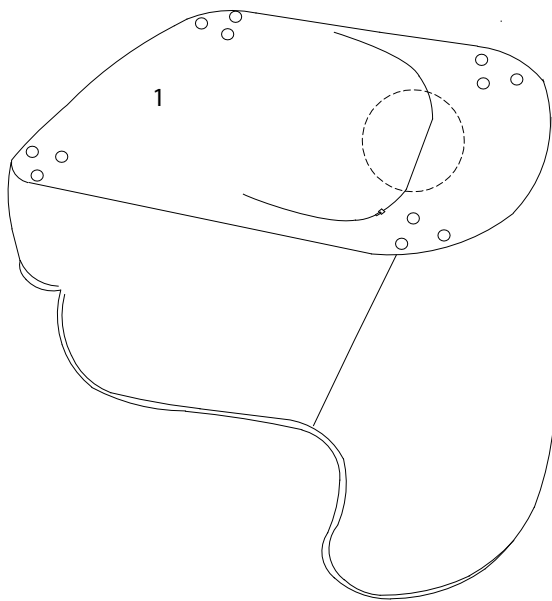

2

